

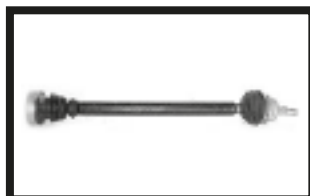

SEMIASSI

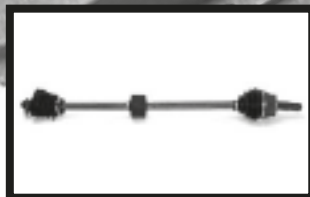

Rad.i.ni. s.r.l.

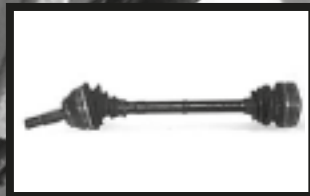
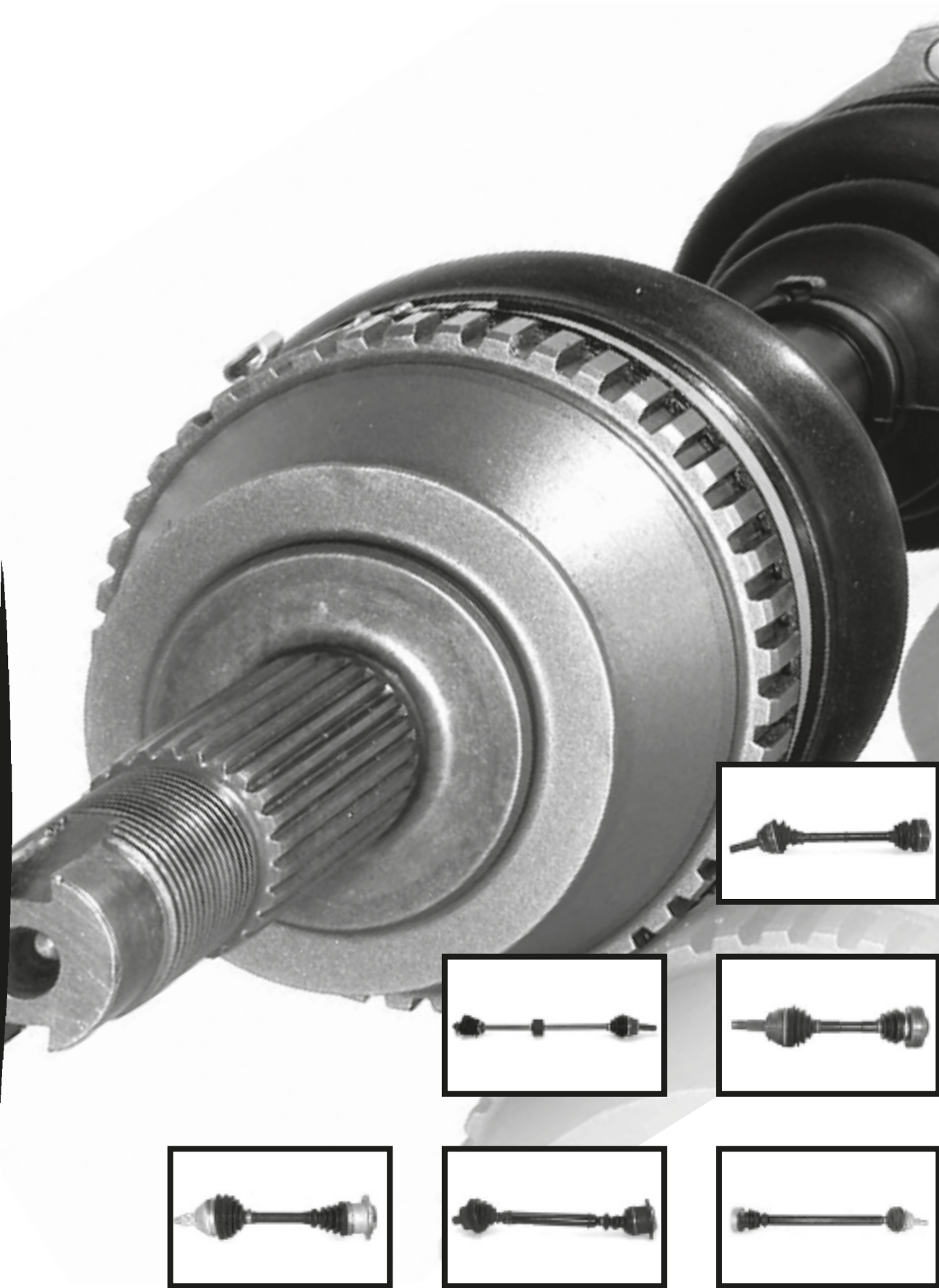



ALFA ROMEO 9	ZX 65	CONCERTO 122	ML ANTERIORE 160	PARTNER RANCH 221	FORESTER 280
33 9	DACIA 66	JAZZ 122	ML POSTERIORE 161	RANCH 222	JUSTY 280
145 - 146 9	DUSTER 66	ACCENT 123	SMART FOR TWO 161	CLIO 223	SUBARU 280
147 11	LOGAN 66	ATOS 123	SMART FOR FOUR 162	ESPACE 226	LEGACY 281
155 12	DACIA 66	ATOS PRIME 123	VIANO 162	EXPRESS 229	ALTO 282
156 13	SANDERO 67	COUPÉ 123	VITO 162	KANGOO 229	SUZUKI 282
156 CROSS WAGON 14	AVEO 68	HYUNDAI 123	COOPER 164	KOLEOS 231	BALENO 283
159 14	CAPTIVA 68	GETZ 124	MINI 164	LAGUNA 232	GRAN VITARA 284
164 16	ESPERO 68	i10 124	COLT 166	MASTER 235	IGNIS 284
166 16	DAEWOO-CHEVRO-	i20 124	MITSUBISHI 166	MEGANE 238	IGNIS II 285
BRERA 18	LET 68	i 30 125	L 200 167	MEGANE / 238	LIANA 285
GIULIETTA 18	KALOS 69	IX 20 125	LANCER 167	MEGANE / 239	MARUTI 285
GT 19	KALOS CHEVROLET 69	IX 35 125	PAJERO 168	MEGANE CLASSIC 239	S-X4 286
GTV 20	LANOS 69	LANTRA II 126	SPACESTAR 169	MEGANE CLASSIC 239	SPLASH 287
MITO 20	MATIZ CHEVROLET 70	MATRIX 126	ALMERA 170	MEGANE COACH 240	SWIFT 287
SPIDER 22	NEXIA 70	PONY 127	INTERSTAR 170	MEGANE COACH / 240	VITARA 288
80-90 AVANT 24	NUBIRA 70	SANTA FE 128	NISSAN 170	MEGANE CABRIOLET 240	WAGON R 289
AUDI 24	TRAX 71	SONATA 128	JUKE 171	MEGANE COACH / 240	WAGON R+ 289
100 25	TRUCSON 72	TRAJET 129	MICRA 172	MEGANE SW 240	AURIS 290
A1 26	TERIOS 72	MINI 2 CIL. 130	PRIMERA 173	MEGANE COUPÉ / 241	AVENSIS 290
A1 - A1 SPORT BACK 26	DAIHATSU 72	MINI 3 CIL. 130	QASHQAI 174	MEGANE SCENIC 241	TOYOTA 290
A1 SPORT BACK 27	500 73	INNOCENTI 130	X-TRAIL 177	MEGANE SCENIC / 242	AVENSIS VERSO 292
A2 27	FIAT 73	X-TYPE 131	ADAM 178	MEGANE SW 242	AYGO 292
A3 28	500 74	JAGUAR 131	AGILA 178	MEGANE SCENIC 242	CARINA 293
A3 SPORTBACK 31	500 ABARTH 74	CHEROKEE 132	OPEL 178	4x4 242	CELICA 294
A4 32	500 C 74	GRAN CHEROKEE 132	ANTARA 179	MEGANE SCENIC X 242	COROLLA 294
A4 C/AUT. 34	500 L 74	RENEGADE 132	ASTRA F 180	MOD. III 242	COROLLA VERSO 295
A5 35	500 X 76	JEEP 132	ASTRA G 181	MEGANE II 244	IQ 296
A6 35	500 X 4x4 76	WRANGLER 133	ASTRA H 182	MEGANE II / SCENIC 245	PICNIC 296
A6 ALLROAD 37	BRAVO 77	CARENS 134	ASTRA J 184	GRAN SCENIC 245	PRUIS 296
A8 37	BRAVO - BRAVA 78	CARNIVAL 134	CALIBRA 186	MEGANE III 246	RAV 4 I 297
Q3 37	COUPÉ 80	KIA 134	COMBO 186	MODUS 246	RAV 4 II 297
Q5 38	CROMA 81	CERATO 135	COMBO C 187	R4 - R5 - R6 247	RAV 4 III 297
Q7 38	CROMA NUOVA 82	CLARUS 135	CORSA A 187	R9 - 11 247	RAV 4 IV 297
BMW 39	DOBLO 83	PICANTO 136	CORSA B 188	R19 247	URBAN CRUISER 4x4 298
SERIE 1 39	DUCATO 84	RIO 136	CORSA C 188	R21 248	VERSO 298
SERIE 3 E36 39	FIORINO 87	SEPHIA 137	CORSA D 189	R25 248	YARIS 298
SERIE 3 E46 40	FREEMONT 88	SORENTO 137	CORSA E 190	SAFRANE 249	YARIS II 300
SERIE 3 E90 40	GRANDE PUNTO 41	SPORTAGE 137	INSIGNIA 190	SUPER 5 250	YARIS VERSO 300
SERIE 5 41	IDEA 90	NIVA 140	KADETT E 191	TRAFIC 250	BORA 301
X3 42	MAREA 91	LADA 140	MERIVA 192	TRAFIC II 251	CADDY 301
X5 42	MULTIPLA 93	NIVA 140	MOKKA 193	TWINGO 252	VOLKSWAGEN 301
X6 43	PANDA 94	LANCIA 141	MOVANO 193	25 252	EOS 303
Z4 43	PANDA CROSS 96	DELTA 141	SIGNUM 195	25 - 45 254	FOX 303
CHRYSLER 44	PUNTO 96	DELTA III 141	TIGRA 195	75 - TOURER 254	GOLF 304
PT CRUISER 44	QUBO 98	KAPPA 142	VECTRA A 196	100 254	GOLF II 304
VOYAGER 44	SEDICI 99	LYBRA 143	VECTRA B 196	ROVER 254	GOLF III 304
CITROËN 46	SEICENTO 100	MUSA 145	VECTRA C 197	200 - 400 255	GOLF IV 306
AX 46	SERIE 200 100	PHEdra 146	VIVARO 198	400 256	GOLF V 307
BERLINGO 46	STILO 100	THEMA 147	ZAFIRA A 199	600 256	GOLF V PLUS 308
BX 47	TIPO 102	THESIS 147	ZAFIRA B 199	800 257	GOLF V 308
C1 48	ULISSE - SCUDO 103	YPSILON 148	PEUGEOT 201	METRO 258	GOLF VI 311
C2 - C3 49	VIAGGIO 104	ZETA 151	104 201	MINI 258	GOLF VII 312
C3 50	B-MAX 105	LAND ROVER 152	106 201	MONTEGO 259	JETTA 313
C3 - C3 PICASSO 50	COURIER 105	EVOQUE 152	107 202	SAAB 260	LUPO 315
C4 50	FORD 105	FREELANDER 152	1007 203	9.3 260	NEW BEETLE 315
C4 - PICASSO 51	ESCORT 106	MAZDA 154	205 204	9.5 260	PASSAT 315
C5 51	FIESTA 107	121 154	206 205	900 260	POLO 318
C6 53	FIESTA - FUSION 109	323 154	207 206	SEAT 262	POLO VI 322
C8 53	FOCUS 110	626 155	208 208	ALHAMBRA 262	SHARAN 322
C15 54	FOCUS I 110	MAZDA 2 155	2008 208	AROSA 264	TIGUAN 323
C25 54	FOCUS II - C-MAX 111	MAZDA 3 156	306 208	CORDOBA 264	TOUAREG 323
DIANA 55	FOCUS III 111	MAZDA 6 156	307 209	IBIZA - INCA 265	TRANSPORTER 326
DS3 56	FOCUS III - C-MAX 112	190 (W201) 157	308 210	IBIZA 266	UP 327
DS4 56	FOCUS C-MAX 112	CLASSE A 157	309 210	IBIZA IV 268	VENTO 328
EVASION 56	GALAXY 113	CLASSE A E B 157	3008 211	IBIZA V 269	440 - 460 - 480 330
JUMPER 57	KA 114	MERCEDES 157	405 212	LEON 269	850 330
JUMPY 57	KUGA 114	CLASSE A E B (AUT.) 158	406 213	TOLEDO 271	C30 330
LN - LNA 58	MONDEO 115	CLASSE C 159	407 214	SKODA 273	VOLVO 330
NEMO 59	PUMA 116	CLASSE R 159	508 214	FABIA 273	C70 331
SAXO 60	S-MAX 116	CLK 159	5008 215	FABIA COMBI 274	C70 - S70 - V70 332
VISA 61	TRANSIT 117	E (W210) 159	605 215	FAVORIT - FELICIA 274	S40 332
XANTIA 62	TRANSIT CONNECT 119	GL 160	607 216	OCTAVIA 275	S40 - V40 333
XM 62	ACCORD VI 120	MB 160	806 216	SUPERB 277	S60 334
XSARA 63	CIVIC 120	HONDA 120	BIPPER 217	YETI 279	S80 334
XSARA- 63	HONDA 120	CONCERTO 122	BOXER 218	XC70 336	V50 335
XSARA PICASSO 64		JAZZ 122	EXPERT 219	XC90 336	V70 336
XSARA PICASSO 64		ACCENT 123	J5 220		

33	1.3 S-Sportwagon 1.5 4X4-Quadrifoglio	83>88 1.8 Td 83>86	83>89
RIFERIMENTI ORIGINALI			
 <p>← Lungh. Tot. = 610 mm → Cave 28 Ø 94</p>		<p>547679 547680 795283 795284</p>	 <p>← Lungh. Tot. = 610 mm → Ø 94 Cave 28</p>
LATO SX AR 00101			AR 00101 LATO DX



NOTE

33	1.3 S-Sportwagon 1.5 4X4-Quadrifoglio	88>89 1.7 ie-Sport W S W 4X4 86>89 Quadrif. Sportwagon	83>89
RIFERIMENTI ORIGINALI			
 <p>← Lungh. Tot. = 600 mm → Cave 28 Ø 94</p>		<p>548135</p>	 <p>← Lungh. Tot. = 600 mm → Ø 94 Cave 28</p>
LATO SX AR 00102			AR 00102 LATO DX

NOTE

33	1.3 S-Sportwagon 1.4 ie	1990 1.5 ie-Sport W 1990 1.7 ie 16v-QV4 Sport W	1990 1.8 Turbo D 1990
RIFERIMENTI ORIGINALI			
 <p>← Lungh. Tot. = 590 mm → Cave 25 Ø 94</p>		<p>60564944 60559887</p>	 <p>← Lungh. Tot. = 590 mm → Ø 94 Cave 25</p>
LATO SX AR 00103 - AR 00103/A			AR 00103 - AR 00103/A LATO DX

NOTE ABS 44D su richiesta

145 - 146	1.4 ie7 T.S. 76Kw 1.4 i.c. 16V T.S.	97>99 >11/98	
RIFERIMENTI ORIGINALI			
 <p>← Lungh. Tot. = 580 mm → Cave 25 Rullo Ø 32</p>		<p>46307694</p>	 <p>← Lungh. Tot. = 945 mm → Rullo Ø 32 Cave 25</p>
LATO SX AR 00104 - AR 00104/A			AR 00105 - AR 00105/A LATO DX

NOTE ABS 44D su richiesta

145 - 146

146 1.4 TS 16v 76Kw
145 1.4 TS 16v 76Kw11/98>01
98>02← Lungh. Tot. = 530 mm →
Cave 25 Rullo Ø 32

LATO SX

AR 00136

RIFERIMENTI ORIGINALI

← Lungh. Tot. = 945 mm →
Rullo Ø 32 Cave 25

AR 00137

LATO DX

NOTE Fonico Ø 51

145 - 146

1.3 Boxer
1.6 Boxer94>96 | 1.7 16v
94>96 | 1.4 ie 66Kw94>96 |
94>96← Lungh. Tot. = 640 mm →
Cave 25 Ø 94

LATO SX

AR 00106 - AR 00106/A

RIFERIMENTI ORIGINALI

46307046
60583484

A = ABS 44

A = ABS 44

← Lungh. Tot. = 640 mm →
Ø 94 Cave 25

AR 00106 - AR 00106/A

LATO DX

NOTE ABS 44D su richiesta

145 - 146

1.6 ie 16v Ts 88Kw
146 1.8 ie 16v Ts 103Kw1997> | 1.9 Td 66Kw
1997> | 2.0 16v T.S. 110Kw1994>1999
1998>← Lungh. Tot. = 485 mm →
Cave 25 Ø 100

LATO SX

AR 00107 - AR 00107/A

RIFERIMENTI ORIGINALI

46417264
60810213
60811528

A = ABS 44

A = ABS 44

← Lungh. Tot. = 485 mm →
Ø 100 Cave 25

AR 00107 - AR 00107/A

LATO DX

NOTE ABS 44D su richiesta

145 - 146

1.6 ie 16v 88Kw
1.8 ie 16v 103Kw11/1996> | 1.9 Td 66Kw
12/96>12/98 | 2.0 16v 110Kw1994>1999 | 2.0 16v Quadrifoglio 03/98>01/01
10/95>01/01← Lungh. Tot. = 485 mm →
Cave 25 Ø 100

LATO SX

AR 00160

RIFERIMENTI ORIGINALI

46307013
46417261← Lungh. Tot. = 485 mm →
Ø 100 Cave 25

AR 00160

LATO DX

NOTE Fonico Ø 51

145 - 146	1.9 Jtd 77Kw	1999 >	
	RIFERIMENTI ORIGINALI		
← Lungh. Tot. = 510 mm → Cave 25 Ø 108 H 49	46307473	46307474	← Lungh. Tot. = 510 mm → Ø 108 Cave 25
LATO SX AR 00131			AR 00108 LATO DX
NOTE Fonico Ø 59			

147	1.6 16v. T.S. 77/88Kw 1.9 JTD 74Kw	2001> fino 09/06	2.0 16v. T.S. 110Kw 2.0 16v. 110Kw	01>05
	RIFERIMENTI ORIGINALI			
← Lungh. Tot. = 495 mm → Cave 25 Ø 100	46307650 46307651		← Lungh. Tot. = 495 mm → Ø 100 Cave 25	
LATO SX AR 00130			AR 00130 LATO DX	
NOTE Fonico Ø 51				

147	1.9 JTD 85Kw	01>04	1.9 JTD 16v 108Kw fino al telaio n.3145308	2004>
	RIFERIMENTI ORIGINALI			
← Lungh. Tot. = 516 mm → Cave 25 Ø 108 H 49	46307653 71720882 71783010	46307651 46307654	← Lungh. Tot. = 516 mm → Ø 108 H 32 Cave 25	
LATO SX AR 00132			AR 00133 LATO DX	
NOTE Fonico Ø 51				

147	1.9 JTDM 85/88Kw	2004>	1.9 JTDM 16v 103/100/110Kw dal telaio n.3145308	2004>
	RIFERIMENTI ORIGINALI			
← Lungh. Tot. = 615 mm → Cave 25 Cave 25	46308023	46308024 46308072	← Lungh. Tot. = 935 mm → Cave 25 Cave 25	
LATO SX AR 00138			AR 00139 LATO DX	
NOTE Fonico Ø 51				

147

3.2 GTA 191Kw dal 2008 > 2010



← Lungh. Tot. = 628 mm →
Cave 25 Cave 34

LATO SX

AR 00148

RIFERIMENTI ORIGINALI



← Lungh. Tot. = 927 mm →
Cave 34 Cave 25

AR 00149

LATO DX

NOTE Fonico Ø 51

155

2.5 TD 92Kw

1993/1997



← Lungh. Tot. = 500 mm →
Cave 25 Ø 108

LATO SX

AR 00111 - AR 00111/A

RIFERIMENTI ORIGINALI

60545288
60545289
60812895



← Lungh. Tot. = 500 mm →
Ø 108 Cave 25

AR 00111 - AR 00111/A

LATO DX

NOTE ABS 44D su richiesta

155

1.7 TS 83/85Kw
1.8 IE TS 77Kw93>97
92>97

2.0 TS 104/106/110Kw

92>97



← Lungh. Tot. = 460 mm →
Cave 25 Ø 100

LATO SX

AR 00109 - AR 00109/A

RIFERIMENTI ORIGINALI

60563302

A = ABS 44

A = ABS 44



← Lungh. Tot. = 460 mm →
Ø 100 Cave 25

AR 00109 - AR 00109/A

LATO DX

NOTE ABS 44D su richiesta

155

1.9 TD 66Kw
1.6 16v TS 88Kw1996>
1996>

1.7 16v TS 103Kw

2.0 16v TS 110Kw

1996>
1996>

← Lungh. Tot. = 478 mm →
Cave 25 Ø 100

LATO SX

AR 00110 - AR 00110/A

RIFERIMENTI ORIGINALI

60563302
46417264
60810213
60811528
60812765

A = ABS 44

A = ABS 44





← Lungh. Tot. = 478 mm →
Ø 100 Cave 25



AR 00110 - AR 00110/A

LATO DX



NOTE ABS 44D su richiesta

156	1.6 16v. TS 88Kw	97>05	2.0 16v. TS 110/114Kw	1997>
	1.8 16v. TS 103/106Kw	97>00	2.0 JTD 122Kw	97>05
RIFERIMENTI ORIGINALI				
 <p>← Lungh. Tot. = 490 mm → Cave 25 Ø 100</p>		<p>46307144 46307304 46307316 46307342</p>	 <p>← Lungh. Tot. = 490 mm → Ø 100 Cave 25</p>	
LATO SX AR 00112			AR 00112 LATO DX	



NOTE Fonico Ø 59

156	1.9 JTD 77Kw	09/97>10/00	1.9 JTD 100/103Kw	11/02>09/05	
	1.9 JTD 81/85Kw	10/00>01			
RIFERIMENTI ORIGINALI					
 <p>← Lungh. Tot. = 516 mm → Cave 25 Ø 108 H 49</p>		<p>46307345 71720909</p>	<p>46307346 60651295</p>	 <p>← Lungh. Tot. = 516 mm → Ø 108 H32 Cave 25</p>	
LATO SX AR 00113				AR 00114 LATO DX	

NOTE Fonico Ø 59

156	1.9 JTD 85/100Kw	05/01>09/05	1.9 JTD 16v 100/103Kw	11/02>09/05	
RIFERIMENTI ORIGINALI					
 <p>← Lungh. Tot. = 615 mm → Cave 25 Cave 25</p>		<p>46308071 60802018 46308025</p>	<p>46308024 71787158</p>	 <p>← Lungh. Tot. = 935 mm → Cave 25 Cave 25</p>	
LATO SX AR 00125			Fusello L/C 377mm	AR 00126 LATO DX	

NOTE Fonico Ø 59

156	2.4 JTD 100/103Kw	97>02		
	2.4 JTD 110Kw	2002>		
RIFERIMENTI ORIGINALI				
 <p>← Lungh. Tot. = 475 mm → Cave 25 Ø 108 H 49</p>		<p>46307343</p>	 <p>← Lungh. Tot. = 475 mm → Ø 108 H 49 Cave 25</p>	
LATO SX AR 00128			AR 00128 LATO DX	

NOTE Fonico Ø 59

156

2.4 JTD 129Kw

2003>



← Lungh. Tot. = 550 mm →
Cave 25 Cave 27

LATO SX

AR 00142

RIFERIMENTI ORIGINALI

46308089

46307741

Fusello L/C 490mm



← Lungh. Tot. = 1003 mm →
Cave 27 Cave 25

AR 00143

LATO DX

NOTE Fonico Ø 59

156 Cross Wagon

Q4 1.9 JTDM 110kw

2004>2006



← Lungh. Tot. = 510 mm →
Cave 25 Stellare 72

LATO SX

AR 00161

RIFERIMENTI ORIGINALI

46308215

46308214



← Lungh. Tot. = 540 mm →
Stellare Ø 72 Cave 25

AR 00162

LATO DX

NOTE Semiassi posteriori

159

1.9 JTDM 16v 100/110Kw
1.9 JTDM 8v 88Kw2005>
2005>2.2 JTS 136Kw
Brera 2.2 JTS 136Kw2005>
06/10

← Lungh. Tot. = 640 mm →
Cave 30 Cave 25

LATO SX

AR 00134

RIFERIMENTI ORIGINALI

51876370
46308297
50506052850506024
51876374
50500522
50504034

Fusello L/C 440mm



← Lungh. Tot. = 1015 mm →
Cave 25 Cave 30

AR 00135

LATO DX

NOTE Fonico Ø 61

159

2.4 JTDM 20v 147/154Kw 2005>



← Lungh. Tot. = 600 mm →
Cave 30 Cave 27

LATO SX

AR 00144

RIFERIMENTI ORIGINALI

50500529
51876349
5051713850500523
51676350

Fusello L/C 498mm





← Lungh. Tot. = 1055 mm →
Cave 27 Cave 30

AR 00145

LATO DX

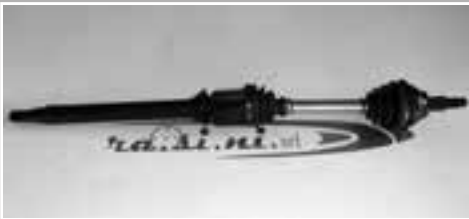
NOTE Fonico Ø 62

159	1.8 103/147Kw	2005>	RIFERIMENTI ORIGINALI	
	46308276 50500526 51876377	46308293 50517123 51876378		
← Lungh. Tot. = 670 mm → Cave 30 Cave 22	Fusello L/C 439mm		← Lungh. Tot. = 1010 mm → Cave 22 Cave 30	
LATO SX AR 00150			AR 00151 LATO DX	
NOTE Fonico Ø 61				

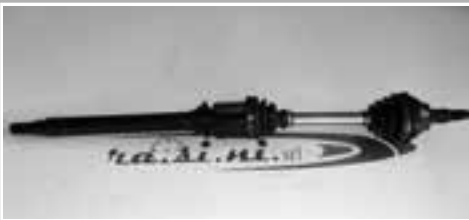
159	2.0 JTD 120/125Kw 2.4 JTDM Q4 154kw	09>11 2007>	3.2 JTS Q4 191Kw	2005>2008
	50506263	RIFERIMENTI ORIGINALI		
← Lungh. Tot. = 635 mm → Cave 30 Cave 27	Fusello L/C 453mm		← Lungh. Tot. = 1025 mm → Cave 27 Cave 30	
LATO SX AR 00175			AR 00176 LATO DX	
NOTE Fonico Ø 61				

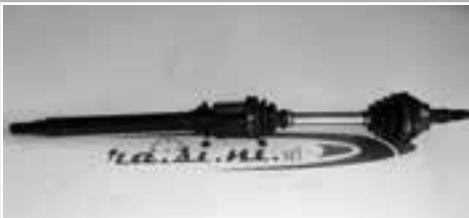
159	2.0 JTDM /120/125Kw 3.2 JTS 195 Kw 2005>	2011>	RIFERIMENTI ORIGINALI	
	50519319	50519320 51876365		
← Lungh. Tot. = 630 mm → Cave 30 Cave 27	Fusello L/C 454mm		← Lungh. Tot. = 1030 mm → Cave 27 Cave 30	
LATO SX AR 00190			AR 00191 LATO DX	
NOTE				

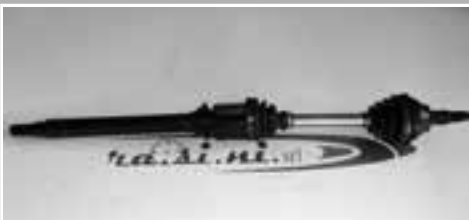
159	2.0 JTD 100Kw	2010>	RIFERIMENTI ORIGINALI	
	RIFERIMENTI ORIGINALI			
← Lungh. Tot. = 640 mm → Cave 30 Cave 25	Fusello L/C 440mm Paraolio Ø 32 Paraolio Ø 30		← Lungh. Tot. = 1025 mm → Cave 25 Cave 30	
LATO SX AR 00192			AR 00193 LATO DX	
NOTE				

159

1.9 JTS 118Kw

2008>



← Lungh. Tot. = 630 mm →
Cave 30 Cave 25

LATO SX

AR 00196

RIFERIMENTI ORIGINALI

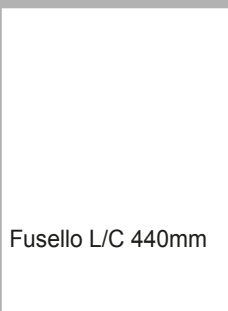
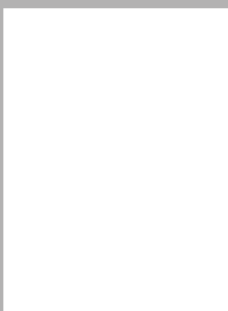

Fusello L/C 440mm

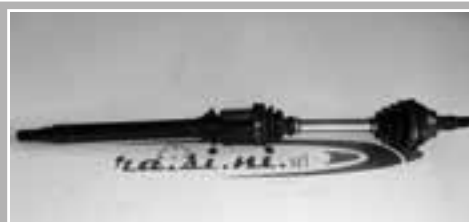

← Lungh. Tot. = 1027 mm →
Cave 25 Cave 30

AR 00197

LATO DX

NOTE

164

2.0 T TS 105/109Kw
2.0 ie Turbo 128Kw87>92
87>98

← Lungh. Tot. = 518 mm →
Cave 25 Ø 100

LATO SX

AR 00117 - AR 00117/A

RIFERIMENTI ORIGINALI

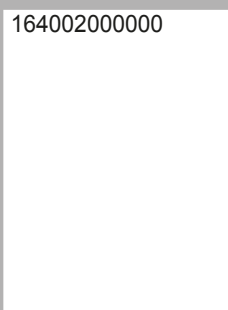

164002000000

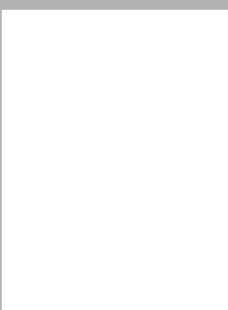

← Lungh. Tot. = 518 mm →
Ø 100 Cave 25

AR 00117 - AR 00117/A

LATO DX

NOTE ABS 90D su richiesta

164

2.0 Super V6 Turbo
2.5 TD87>98
87>98

3.0 V6 Tutti i modelli

87>98



← Lungh. Tot. = 513 mm →
Cave 27 Ø 108

LATO SX

AR 00118 - /A - /B

RIFERIMENTI ORIGINALI

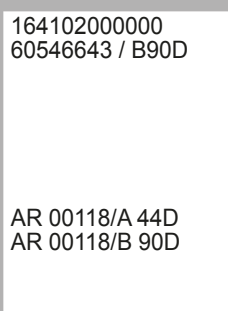
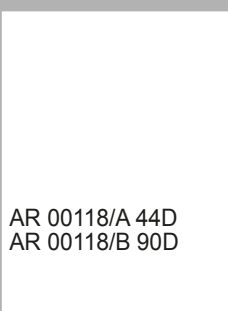
164102000000
60546643 / B90DAR 00118/A 44D
AR 00118/B 90D

← Lungh. Tot. = 513 mm →
Ø 108 Cave 27

AR 00118 - /A - /B

LATO DX

NOTE ABS 90D - 44D su richiesta

166

2.4 JTD 103/100/110Kw

1997>



← Lungh. Tot. = 517 mm →
Cave 27 Ø 108 H 49

LATO SX

AR 00120

RIFERIMENTI ORIGINALI

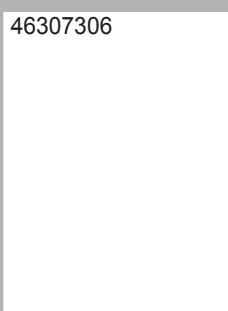

46307306

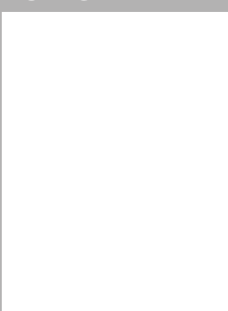

← Lungh. Tot. = 517 mm →
Ø 108 H 49 Cave 27

AR 00120

LATO DX

NOTE Fonico Ø 59

166	2.0 V6 Turbo 151Kw 2.5 V6 Turbo 24v 140Kw	1998> 1998>	3.0 V6 24v 166Kw	1998>
	RIFERIMENTI ORIGINALI			
	46307447 46307514			
← Lungh. Tot. = 540 mm Cave 27 Ø 108 →			← Lungh. Tot. = 477 mm Ø 108 →	Cave 27
LATO SX	AR 00119		AR 00122	LATO DX

NOTE Fonico Ø 59

166	2.0 TS 16v 110/114Kw	1998>		
	RIFERIMENTI ORIGINALI			
	71782998			
← Lungh. Tot. = 532 mm Cave 27 Ø 100 →			← Lungh. Tot. = 532 mm Ø 100 →	Cave 27
LATO SX	AR 00121		AR 00121	LATO DX

NOTE Fonico Ø 59

166	2.4 JTDM-Jet 129/136Kw	2003>		
	RIFERIMENTI ORIGINALI			
	46308163	46308164		
← Lungh. Tot. = 605 mm Cave 27 Cave 27 →		Fusello L/C 430mm	← Lungh. Tot. = 980 mm Cave 27 →	Cave 27
LATO SX	AR 00146		AR 00147	LATO DX

NOTE Fonico Ø 59

166	2.4 JTD 129/136Kw C/A	2003>		
	RIFERIMENTI ORIGINALI			
	46308131	46308132		
← Lungh. Tot. = 580 mm Cave 27 Cave 26 →			← Lungh. Tot. = 971 mm Cave 26 →	Cave 27
LATO SX	AR 01001		AR 01002	LATO DX

NOTE Fonico Ø 59

Brera

2.4 JTDM 20V 147/154Kw

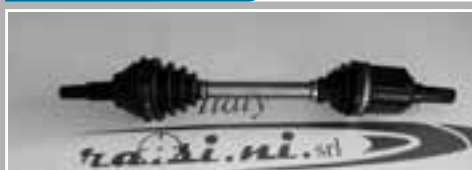

← Lungh. Tot. = 595 mm →
Cave 30 Cave 27

LATO SX

AR 00144

RIFERIMENTI ORIGINALI

50517138

50517126

Fusello L/C 453mm



← Lungh. Tot. = 1025 mm →
Cave 27 Cave 30

AR 00176

LATO DX

NOTE Fonico Ø 61

Giulietta

1.8 TBI 165/173Kw 04/2010
2.0 JTD 100/103/110/125Kw 04/2010>

← Lungh. Tot. = 625 mm →
Cave 27 Cave 25

LATO SX

AR 00172

RIFERIMENTI ORIGINALI

51806992

50518639
50521847

Paraolio Ø32

Staffa 62mm
Paraolio Ø30
Fusello L/C 410mm

← Lungh. Tot. = 974 mm →
Cave 25 Cave 27

AR 00173

LATO DX

NOTE Fonico Ø 59

Giulietta

1.8 TBI 169/173Kw 2010>
2.0 JTD 125Kw C/A 2010>

← Lungh. Tot. = 598 mm →
Cave 27 Cave 25

LATO SX

AR 00194

RIFERIMENTI ORIGINALI

50518639

Fusello L/C 450mm



← Lungh. Tot. = 985 mm →
Cave 25 Cave 27

AR 00195

LATO DX

NOTE

Giulietta

1.8 TRB 169/173Kw



← Lungh. Tot. = 622 mm →
Cave 27 Cave 25

LATO SX

AR 00172

RIFERIMENTI ORIGINALI

Fusello L/C 454mm



← Lungh. Tot. = 980 mm →
Cave 25 Cave 27

AR 00153

LATO DX

NOTE

Giulietta	1.4 TB 110Kw 1.6 JTD 85Kw	2010> 2010>	1.6 JTD.77Kw 2.0 JTD 103/110/125Kw	2010> 2010>
	RIFERIMENTI ORIGINALI			
← Lungh. Tot. = 603 mm → Cave 27 Cave 25	50518638		Staffa 67mm Fusello L/C 410mm Paraolio Ø30	← Lungh. Tot. = 970 mm → Cave 25 Cave 27
LATO SX	AR00170			AR00169 LATO DX

NOTE 25/26 Staffa 67

Giulietta	1.4 TB 77/88Kw 1.4 TB 125Kw C/A	2011> 2010>	1.4 Bi-Fuel 88Kw 1.6 JTD 77Kw	2011> 04/2010>	2.0 JTD 103/110/125Kw	2010>
	RIFERIMENTI ORIGINALI					
← Lungh. Tot. = 603 mm → Cave 27 Cave 25	50518638 51806989		51806989 55213053		Staffa 62mm Paraolio Ø30 Fusello L/C 410mm	← Lungh. Tot. = 970 mm → Cave 25 Cave 27
LATO SX	AR 00170	Paraolio Ø32				AR 00171 LATO DX

NOTE Fonico Ø 59

Giulietta	1.8 TBI 177Kw					
	RIFERIMENTI ORIGINALI					
← Lungh. Tot. = 622 mm → Cave 27 Cave 25	51806992 50522036		50521847		Staffa 67mm Paraolio Ø30 Fusello L/C 410mm	
LATO SX	AR 00172	Paraolio Ø32				← Lungh. Tot. = 985 mm → Cave 25 Cave 27
						AR 00185 LATO DX

NOTE Fonico Ø 59

GT	1.9 JTDM 110/125Kw	2002>		
	RIFERIMENTI ORIGINALI			
← Lungh. Tot. = 615 mm → Cave 25 Cave 25	46308023 71787113		46308024 46308072 71787138	
LATO SX	AR 00125			
				← Lungh. Tot. = 935 mm → Cave 25 Cave 25
				AR 00126 LATO DX

NOTE Fonico Ø 59

GTV

1.8 V6 TS 106Kw
2.0 V6 TS 110Kw1998>
95>97← Lungh. Tot. = 484 mm →
Cave 25 Ø 100

LATO SX

AR 00123

RIFERIMENTI ORIGINALI

60562865
60815369← Lungh. Tot. = 484 mm →
Ø 100 Cave 25

AR 00123

LATO DX

NOTE ABS 44

GTV

2.0 V6 Turbo 148Kw
3.0 V6 12v 141Kw95>97 | 3.0 V6 24v 162Kw
95>97

95>97

← Lungh. Tot. = 500 mm →
Cave 25 Ø 108

LATO SX

AR 00127

RIFERIMENTI ORIGINALI

60617511

← Lungh. Tot. = 500 mm →
Ø 108 Cave 25

AR 00127

LATO DX

NOTE ABS 44

GTV

1.8 16v TS 106Kw
2.0 16v TS 110Kw1998>2005
1998>2005← Lungh. Tot. = 490 mm →
Cave 25 Ø 100

LATO SX

AR 00152

RIFERIMENTI ORIGINALI

60815369
60562865← Lungh. Tot. = 490 mm →
Ø 100 Cave 25

AR 00152

LATO DX

NOTE Fonico Ø 51

Mito

1.3 MJT 70Kw 6 marce

2009>

← Lungh. Tot. = 615 mm →
Cave 25 Cave 24

LATO SX

AR 00180

RIFERIMENTI ORIGINALI

46308523

518167654

Fusello L/C 380mm

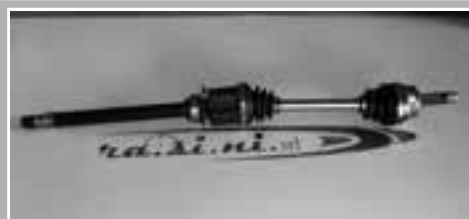
← Lungh. Tot. = 980 mm →
Cave 24 Cave 25

AR 00198

LATO DX

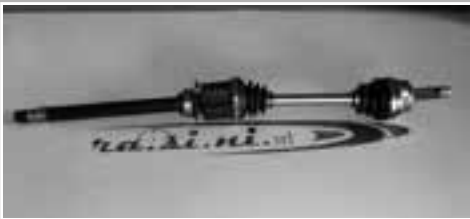

NOTE Fonico Ø 51

Mito 1.3 MJ 70Kw 5 marce 2011>

RIFERIMENTI ORIGINALI	
 <p>Lungh. Tot. = 625mm Cave 25 Cave 24</p> <p>LATO SX FI 01012</p>	<p>51806992</p>
 <p>Lungh. Tot. = 907 mm Cave 24 Cave 25</p> <p>FI 01013 LATO DX</p>	



NOTE

Mito 1.3 MJet 66/70Kw 5marce 08>11

RIFERIMENTI ORIGINALI	
 <p>Lungh. Tot. = 615 mm Cave 25 Cave 24</p> <p>LATO SX AR 00180</p>	<p>51827230 51947028 51808108 46308523</p> <p>Fusello L/C 380mm</p>
 <p>Lungh. Tot. = 905 mm Cave 24 Cave 25</p> <p>AR 00181 LATO DX</p>	



NOTE Fonico Ø 51

Mito 1.3 JTDM 66/70Kw 6 marce 08>11
1.3 MJ 70Kw 6 marce 10/09

RIFERIMENTI ORIGINALI	
 <p>Lungh. Tot. = 580 mm</p> <p>LATO SX FI 00198</p>	<p>46308409 46308523</p> <p>Fusello L/C 400mm</p>
 <p>Lungh. Tot. = 952 mm</p> <p>FI 00199 LATO DX</p>	<p>46308043 46308524 51816765</p>

NOTE

Mito 1.4 T-jet 88/99Kw 05/2008>

RIFERIMENTI ORIGINALI	
 <p>Lungh. Tot. = 630 mm Cave 25 Cave 24</p> <p>LATO SX AR 00163</p>	<p>55207526</p> <p>Fusello L/C 390mm</p>
 <p>Lungh. Tot. = 920 mm Cave 24 Cave 25</p> <p>AR 00164 LATO DX</p>	

NOTE Fonico Ø 51

Mito	1.4 TB 120Kw 1.6 JTD 88Kw	2008> 2011>		
	RIFERIMENTI ORIGINALI			
← Lungh. Tot. = 575 mm → Cave 25 Cave 25	Paraolio Ø32	Paraolio Ø30 Fusello L/C 430mm	← Lungh. Tot. = 955 mm → Cave 25 Cave 25	
LATO SX	AR 00182		AR 00183	LATO DX

NOTE

Mito	1.4 51/57/58/70Kw 1.4 T Jet 88Kw	2008> 2008>	1.4 Bi-Fuel 88Kw 2011>	
	RIFERIMENTI ORIGINALI			
← Lungh. Tot. = 645 mm → Cave 22 Cave 22	55700562 55700560 51754514	55700559 55700557 51754513	← Lungh. Tot. = 890 mm → Cave 22 Cave 22	
LATO SX	AR 00158		AR 00159	LATO DX

NOTE Fonico Ø 51

Mito	1.4 TB 103Kw 1.4 T.Jet 114Kw	2013> 2008>	1.4 T.Multiar 120/125Kw 1.6 JTD 85/88Kw	2009> 2008>
	RIFERIMENTI ORIGINALI			
← Lungh. Tot. = 590 mm → Cave 25 Cave 25	55700614 71745016	55700614 51807675	← Lungh. Tot. = 955 mm → Cave 25 Cave 25	
LATO SX	AR 00165	Paraolio Ø35 Fusello L/C 430mm	AR 00166	LATO DX

NOTE Fonico Ø 51 - Paraolio Ø 35

Spider	2.0 JTD 120/125Kw 2.2 JTS 136Kw	2006>		
	RIFERIMENTI ORIGINALI			
← Lungh. Tot. = 640 mm → Cave 30 Cave 25			← Lungh. Tot. = 1015 mm → Cave 25 Cave 30	
LATO SX	AR 00134		AR 00135	LATO DX

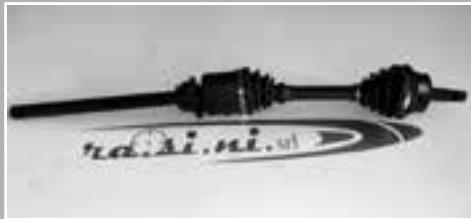

NOTE

Spider		2.4 JTD 147/154Kw	2007>	
 <p>Lungh. Tot. = 600 mm Cave 30 Cave 27</p>	RIFERIMENTI ORIGINALI		 <p>Lungh. Tot. = 1035 mm Cave 27 Cave 30</p>	
		50500529 5187649		50500523 51876350
LATO SX	AR 00144		AR 00145	LATO DX

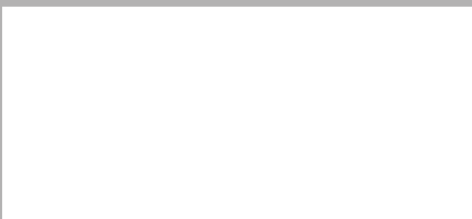
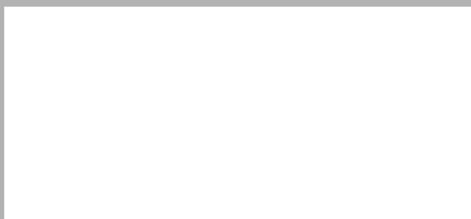
NOTE

 <p>Lungh. Tot. =</p>	RIFERIMENTI ORIGINALI		 <p>Lungh. Tot. =</p>	
LATO SX				LATO DX

NOTE

 <p>Lungh. Tot. =</p>	RIFERIMENTI ORIGINALI		 <p>Lungh. Tot. =</p>	
LATO SX				LATO DX

NOTE



 <p>Lungh. Tot. =</p>	RIFERIMENTI ORIGINALI		 <p>Lungh. Tot. =</p>	
LATO SX				LATO DX



NOTE



80-90 Avant	1.6-CC-D CC-DD-E/S-TD 40/51/52/55/59Kw	88>10/91	1.8-E-S-D-S 59/66Kw 1.9 D-TD 48/55Kw	88>91 2.0 66Kw 88>91	91>10/91
RIFERIMENTI ORIGINALI					
 <p>← Lungh. Tot. = 582 mm → Cave 33 Ø 94</p>		<p>441407271 895407271* 895407271C</p>		<p>895407272* 895407272C</p>	
LATO SX AU 00101 - AU 00101/A*				LATO DX AU 00102 - AU 00102/A*	
NOTE 80 - 90 ABS 45D su richiesta					



80-90 Avant	1.6 E/S 52/72Kw 1.8 E-GTE 82Kw	90>94 1.9 TD 55Kw 88>94	2.0 E 66/81/83/85Kw	88>94 88>94	
RIFERIMENTI ORIGINALI					
 <p>← Lungh. Tot. = 584 mm → Cave 33 Ø 100</p>		<p>8A0407271AE* 893407271L 895407271D*</p>		<p>8A0407272AE* 893407272L 895407272D*</p>	
LATO SX AU 00103 - AU 00103/A*				LATO DX AU 00104 - AU 00104/A*	
NOTE 80 - 90 ABS 45D su richiesta					



80-90 Avant	1.6 75Kw 2.0 E 16v 103/118Kw	92>93 2.3 E 98Kw 88>91		88>94	
RIFERIMENTI ORIGINALI					
 <p>← Lungh. Tot. = 585 mm → Cave 33 Ø 108</p>		<p>893407271N 893407271P* 893407271*</p>		<p>893407272N 893407272P* 893407272*</p>	
LATO SX AU 00105 - AU 00105/A*				LATO DX AU 00106 - AU 00106/A*	
NOTE 80 - 90 ABS 45D su richiesta					

80-90 Avant	2.0 E 85Kw 2.0 16v 103Kw	92>96 2.3 E 98Kw 93>96	2.6 V6 110Kw	92>96 2.8 128Kw 92>94	91>94
RIFERIMENTI ORIGINALI					
 <p>← Lungh. Tot. = 600 mm → Cave 38 Ø 100</p>		<p>8A05012033 8A0501203E</p>		 <p>← Lungh. Tot. = 600 mm → Ø 100 Cave 38</p>	
LATO SX AU 00138/A				LATO DX AU 00138/A	
NOTE ABS 45D					

80-90 Avant		1.9 TDI 66Kw	91>96	
 <p>← Lungh. Tot. = 570 mm Cave 33 Ø 130 →</p>	RIFERIMENTI ORIGINALI		 <p>← Lungh. Tot. = 560 mm Ø 130 Cave 33 →</p>	
	8A0407271A* 8A0407271AG*	8A0407272A*		A = ABS 45
LATO SX AU 00109 - AU 00109/A*				AU 00110 - AU 00110/A* LATO DX
NOTE ABS 45D				

100		2.5 TDI 85Kw 2.8 E 128Kw	91>94 90>94	
 <p>← Lungh. Tot. = 613 mm Cave 38 Ø 130 →</p>	RIFERIMENTI ORIGINALI		 <p>← Lungh. Tot. = 648 mm Ø 130 Cave 38 →</p>	
	4A0407272BD* 4A0407272DF*	4A0407272BH* 4A0407272DE*		A = ABS 45
LATO SX AU 00132 - AU 00132/A*				AU 00133 - AU 00133/A* LATO DX
NOTE ABS 45D su richiesta				

100		2.0 16v-E 74/85/103Kw 2.3 100Kw	91>94 91>94	
 <p>← Lungh. Tot. = 623 mm Cave 38 Ø 108 →</p>	RIFERIMENTI ORIGINALI		 <p>← Lungh. Tot. = 664 mm Ø 108 Cave 38 →</p>	
	4A0407272BH 4A0407272DE 4A0407271AF* 4A0407271F*	4A0407272B* 4A0407272D 4A0407272DD*		A = ABS 45
LATO SX AU 00107 - AU 00107/A*				AU 00108 - AU 00108/A* LATO DX
NOTE ABS 45D su richiesta				

100		2.4 D 60Kw 2.6 E 110Kw	91>94 92>94	
 <p>← Lungh. Tot. = 615 mm Cave 38 Ø 130 →</p>	RIFERIMENTI ORIGINALI		 <p>← Lungh. Tot. = 650 mm Ø 130 Cave 38 →</p>	
	4A0407271BG 4A0407272AR 4A0407272CR* 4A0407272DF*	4A0407271BG 4A0407272AR 4A0407272BA* 4A0407272DC*		A = ABS 45
LATO SX AU 00129 - AU 00129/A*				AU 00130 - AU 00130/A* LATO DX
NOTE ABS 45D su richiesta				

100 Avant

2.5 TDI 83Kw

1990



← Lungh. Tot. = 600 mm →
Cave 38 Ø 130

LATO SX **AU 00131 - AU 00131/A***

RIFERIMENTI ORIGINALI

4A3407271BP*
4A3407271BQ*
43340727BP*
43340727BQ*

A = ABS 45

A = ABS 45



← Lungh. Tot. = 600 mm →
Ø 130 Cave 38

AU 00131 - AU 00131/A* LATO DX**NOTE** ABS 45D su richiesta

A1

1.6 TDI 66/77Kw
1.6 TDI 85Kw C/A2010>
2014>

← Lungh. Tot. = 490 mm →
Cave 36 Ø 100

LATO SX **VW 01013**

RIFERIMENTI ORIGINALI

6R0407761AX
6R0407761A

6R0407762AX
6R0407762A



← Lungh. Tot. = 785 mm →
Ø 100 Cave 36

VW 01014 LATO DX**NOTE**

A1 - A1 Sport Back

1.4 TFSI 103/136Kw C/A
1.6 TDI 66Kw C/A2011
2011

← Lungh. Tot. = 510 mm →
Cave 36 Cave 108

LATO SX **AU 00193**

RIFERIMENTI ORIGINALI

6R0407761SX
6R0407761S

6R0407762SX
6R0407762S



← Lungh. Tot. = 780 mm →
Ø 108 Cave 36

AU00194 LATO DX**NOTE**

A1 - A1 Sport Back

1.2 TFSI 63Kw
1.4 TFSI 50Kw2010>
2010>

← Lungh. Tot. = 510 mm →
Cave 36 Cave 100

LATO SX **VW 01036**

RIFERIMENTI ORIGINALI



6R0407761KX
6R0407761K

6R0407762KX
6R0407762K



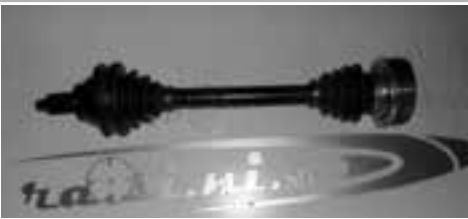

← Lungh. Tot. = 796 mm →
Cave 100 Cave 36

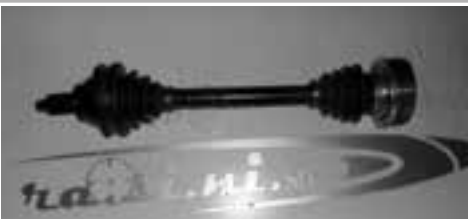

VW 01037 LATO DX**NOTE**

A1 Sport Back	1.4 TDI 66Kw	2014		
 <p>← Lungh. Tot. = 550 mm → Cave 36 Cave 100</p> <p>LATO SX AU 01002</p>	RIFERIMENTI ORIGINALI		 <p>← Lungh. Tot. = 730 mm → Cave 100 Cave 36</p> <p>AU 01003 LATO DX</p>	
	6C0407271E 6C0407271EX	6C0407272C		



NOTE

A1	2.0 TDI 100/105Kw 1.4 TFSI 103Kw	2011> 2012>		
 <p>← Cave 36 → Ø 108</p> <p>LATO SX AU 00191</p>	RIFERIMENTI ORIGINALI		 <p>← Ø 92 → Cave 36</p> <p>AU 00192 LATO DX</p>	
	6R0407761F	6R0407762F		

NOTE

A1	1.2 TFSI 63Kw	dal 2012>	1.2 TFSI 63Kw 1.4 TFSI 90Kw	dal 2010> dal 2010>	1.4 TFSI 90Kw	dal 2011>
 <p>← Lungh.510 Tot. = mm → Cave36 Ø 100</p> <p>LATO SX VW 01036</p>	RIFERIMENTI ORIGINALI		 <p>← Lungh. Tot. =770 mm → Ø 100 Cave36</p> <p>VW 01037 LATO DX</p>			
	6R0407761Kx	6R0407762Kx				

NOTE

A2	1.4 16v 55Kw	00>05		
 <p>← Lungh. Tot. = 528 mm → Cave 36 Fil 16x1,5 Ø 92</p> <p>LATO SX AU 00125</p>	RIFERIMENTI ORIGINALI		 <p>← Lungh. Tot. = 755 mm → Ø 92 Cave 36 Fil 16x1,5</p> <p>AU 00126 LATO DX</p>	
	8Z0407271AM 8Z0407271AQ	8Z0407272AM 8Z0407272AP 6Q0407272DR 6Q0407272BX 6Q0407272AN 6Q0407272AP		

NOTE Fonico Ø 52

A2

1.4 TDI 55/66Kw

00>95



← Lungh. Tot. = 538 mm →
Cave 36 Fil 16x1,5 Ø 72 Stellare

LATO SX

AU 00127

RIFERIMENTI ORIGINALI

8Z0407271AL
8Z0407271AN
8Z0407271AP

8Z0407272AC
8X0407272AN
8Z0407452AX



← Lungh. Tot. = 722 mm →
Ø 72 Stellare Cave 36 Fil 16x1,5

AU 00128

LATO DX

NOTE Fonico Ø 52

A2

1.6 FSI 81Kw

02>05



← Lungh. Tot. = 530 mm →
Cave 36 Fil 16x1,5 Ø 94

LATO SX

AU 00159

RIFERIMENTI ORIGINALI

8Z0407271AR

8Z0407272AR



← Lungh. Tot. = 752 mm →
Ø 94 Cave 36 Fil 16x1,5

AU 00160

LATO DX

NOTE Fonico Ø 52

A3

1.6 FSI 85Kw 03>07
1.6 FSI Sport Back 85Kw 04>07



← Lungh. Tot. = 553 mm →
Cave 36 Ø 100

LATO SX

VW 00194

RIFERIMENTI ORIGINALI

1K0407271DH

1K0407272HB



← Lungh. Tot. = 787 mm →
Ø 100 Cave 36

VW 00195

LATO DX

NOTE

A3

1.9 TDI 74/96Kw C/A

00>03



← Lungh. Tot. = 518 mm →
Cave 36 Cave 104

LATO SX

AU 00197

RIFERIMENTI ORIGINALI

1J0407271HJ
1J0407271HX

1J0407452SX
1J0407272HD







← Lungh. Tot. = 812 mm →
Cave 104 Cave 36



AU 00198



LATO DX

NOTE

<p>A3</p> <p>1.2 TFSI 77/81Kw 1.4 TFSI 90/92Kw</p>  <p>← Cave 36 → Cave 100</p> <p>LATO SX AU 00199</p>	<p>2013> 1.6 TDI 77/81Kw 2012> 2.0 TDI 81Kw</p> <p>RIFERIMENTI ORIGINALI</p> <p>1K0407763KX 1K4072712B</p> <p>1K0407764KX 1K0407272QN</p>		<p>2013> </p>  <p>← Lungh. Tot. = 820 mm → Cave 100 Cave 36</p> <p>AU 01001 LATO DX</p>
	<p>NOTE</p>		

<p>A3</p> <p>1.8 92Kw 1.9 TDI 66Kw</p>  <p>← Lungh. Tot. = 553 mm → Cave 36 Ø 100</p> <p>LATO SX VW 00115</p>	<p>1996>2003 1.9 TDI 81Kw 1196>2001</p> <p>RIFERIMENTI ORIGINALI</p> <p>1J0407271DL 357407271RV 357407271RX</p> <p>1J0407272BK 1J0407272DB 1J0407272EL</p>		<p>1997>2001 </p>  <p>← Lungh. Tot. = 785 mm → Ø 100 Cave 36</p> <p>VW 00116 LATO DX</p>
	<p>NOTE Fonico Ø 53</p>		

<p>A3</p> <p>1.6 74/75Kw</p>  <p>← Lungh. Tot. = 554 mm → Cave 36 Ø 92</p> <p>LATO SX VW 00117</p>	<p>96>03 </p> <p>RIFERIMENTI ORIGINALI</p> <p>1J0407271AH 1J0407271Q 1J0407271AC 1J0407271AL 1J0407451BX</p> <p>1J0407272F</p>		 <p>← Lungh. Tot. = 822 mm → Ø 92 Cave 36</p> <p>VW 00118 LATO DX</p>
	<p>NOTE Fonico Ø 53</p>		

<p>A3</p> <p>1.8 20v 92/110Kw 1.9 TDI 66/74/81Kw</p>  <p>← Lungh. Tot. = 555 mm → Cave 36 Ø 100</p> <p>LATO SX VW 00119</p>	<p>96>03 96>03 </p> <p>RIFERIMENTI ORIGINALI</p> <p>1J0407271C</p> <p>1J0407272BK 1J0407272DB 1J0407272EL</p>		 <p>← Lungh. Tot. = 825 mm → Ø 100 Cave 36</p> <p>VW 00120 LATO DX</p>
	<p>NOTE Fonico Ø 53</p>		

A3

1.8 T Quattro 132Kw
1.9 TDI 96Kw98/03 | S3 Quattro 154Kw
00>03

99/02

← Lungh. Tot. = 520 mm →
Cave 36 Ø 108

LATO SX

VW 00121

RIFERIMENTI ORIGINALI

1J0407271GC
1J0407271ES
1J0407271EP
1J0407271FD
1J0407271LM1J0407272BJ
1J0407272GC
1J0407272GD
1J0407272KT← Lungh. Tot. = 810 mm →
Ø 108 Cave 36

VW 00122

LATO DX

NOTE Fonico Ø 53

A3

A3 Sport Back 1.6 75Kw
A3 Cabriolet 1.6 75Kw04>13 | 1.6 75Kw
08/10

03>13

← Lungh. Tot. = 544 mm →
Cave 36 Ø 100

LATO SX

AU 00180

RIFERIMENTI ORIGINALI

1K0407271DJ
1K0407451JX1K0407272HK
1K0407272JT
1K0407272BG
1K0407272HL
1K0407452BX← Lungh. Tot. = 798 mm →
Ø 100 Cave 36

AU 00181

LATO DX

NOTE

A3

1.8 TSI 118Kw
Audi A3 S3 188/195Kw06>12 | 2.0 TDI 100/103/125Kw 6 speed 03>
04>12 | Telaio n.8P5A0725012.0 125Kw
2.0 TSI 147Kw

04>13

← Lungh. Tot. = 490 mm →
Cave 36 Ø 108

LATO SX

AU 00155

RIFERIMENTI ORIGINALI

1K0407271BJ
1K0407271EE
1K0407271NP
1K0407451DX
1K0407271ES
1K047271HH1K0407272EN
1K0407272RB
1K0407454DX
1K0407272KF
1K0407272NJ← Lungh. Tot. = 798 mm →
Ø 108 Cave 36

AU 00161

LATO DX

NOTE Fonico Ø 53

A3

2.0 TDI 100/103Kw C/A
2.0 TDI 16 V

03>12

← Lungh. Tot. = 480 mm →
Cave 36 Int. fori 104

LATO SX

AU 00187

RIFERIMENTI ORIGINALI

1K0407271FB
1K0407271HL
1K0407271KB
1K0407453CX1K0407452RX
1K0407272BR

Fusello L/C 300mm

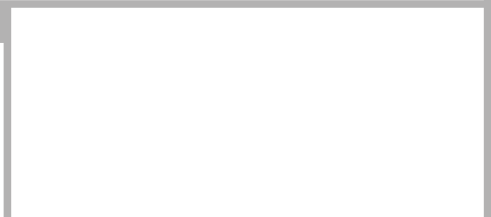
← Lungh. Tot. = 800 mm →
Cave Int. 23 Cave 36

AU 00188

LATO DX

NOTE

A3	1.6 C/A 6 Marce 1.6 FSI.C/A.6.Marce	2.0 FSI 75/80/110Kw C/A	2013>
 <p>← Lungh. Tot. = 585 mm → Cave 36 Cave 26</p>		<p>RIFERIMENTI ORIGINALI</p> <p>1K0407271BD</p> <p>1K0407272FS 1K0407272KB 1K0407452QX</p>	
<p>LATO SX VW 00198</p>		<p>VW 00199 LATO DX</p>	



NOTE

A3	2.0 TFSI 162Kw	2015>	
 <p>← Lungh. Tot. = 480 mm → Cave 36 Int. Fori 104</p>		<p>RIFERIMENTI ORIGINALI</p> <p>1K0407271KA 1K0407271BF</p>	
<p>LATO SX AU 00195</p>		<p>AU 00196 LATO DX</p>	

NOTE



A3 Sportback	1.9 TDI 77Kw 1.6 TDI 66-77 Kw	03>10 09/09>13	
 <p>← Lungh. Tot. = 521 mm → Cave 36 Ø 100</p>		<p>RIFERIMENTI ORIGINALI</p> <p>1K0407271AT 1K0407271CP 1K0407451CX 1K0407451FX</p> <p>1K0407272CC 1K0407272FR 1K0407272GK 1K0407452GX</p>	
<p>LATO SX AU 00153</p>		<p>AU 00154 LATO DX</p>	



NOTE Fonico Ø 59,5



A3 Sportback	1.8 TFSI 118Kw 2.0 TFSI 147Kw	2006> 04>12	2.0 TDI 100/103 Kw 6 speed fino al telaio n.8P5A072500	03>12	
 <p>← Lungh. Tot. = 490 mm → Cave 36 Ø 108</p>		<p>RIFERIMENTI ORIGINALI</p> <p>1K0407271BJ 1K0407271EE 1K0407271NP 1K0407541DX 1K0407541TX</p>		 <p>← Lungh. Tot. = 490 mm → Ø 108 Cave 36</p>	
<p>LATO SX AU 00155</p>		<p>AU 00155 LATO DX</p>			



NOTE Fonico Ø 59,5



AU 00155/M Completo di innesto Lato DX



A3 Sportback	1.9 TDI 77Kw	03/10	2.0 TDI 100/103/125Kw Cambio Automatico	03>13	Dal telaio n.8P5A072501
RIFERIMENTI ORIGINALI					
	1K0407271KA 1K0407271BF	1K0407272QE 1K0407272ER 1K0407272KG 5Q0407272J			
← Lungh. Tot. = 480 mm → Cave 36 Fori Ø10 Int. fori 104				← Lungh. Tot. = 760 mm → Fori Ø10 Int. fori 104 Cave 36	
LATO SX	AU 00157			AU 00158	LATO DX
NOTE Fonico Ø 59,5					



A4	1.8 20v 92/110Kw 1.8 20v Turbo	1994> 1995>			
RIFERIMENTI ORIGINALI					
	8D0407271AQ	8D0407272AQ			
← Lungh. Tot. = 609 mm → Cave 33 Ø 108				← Lungh. Tot. = 635 mm → Ø 108 Cave 33	
LATO SX	AU 00115			AU 00116	LATO DX
NOTE ABS 45D					



A4	1.9 TDI 61/81Kw	1995>			
RIFERIMENTI ORIGINALI					
	8D0407271AN 8D0407451BV 8D0407451FX	8D0407452BV 8D0407452BX 8D0407272AN			
← Lungh. Tot. = 600 mm → Cave 33 Ø 130				← Lungh. Tot. = 620 mm → Ø 130 Cave 33	
LATO SX	AU 00117			AU 00118	LATO DX
NOTE ABS 45D					



A4	1.9 TDI 85Kw	98>01			
RIFERIMENTI ORIGINALI					
	8D0407271BQ 8D0407451NX	8D0407272BQ 8D0407272EK 8D0407452MX			
← Lungh. Tot. = 602 mm → Cave 33 Ø 130				← Lungh. Tot. = 620 mm → Ø 130 Cave 33	
LATO SX	AU 00170			AU 00171	LATO DX
NOTE ABS 45D					

A4	1.6 74/75Kw 1.8 T 110Kw	97>01 96>01		
	RIFERIMENTI ORIGINALI			
← Lungh. Tot. = 613 mm → Cave 33 Ø 100	8D0407271DL 8D0407271BA 8D0407271AP 8D0407451P 8D0407451X	8D0407272DL 8D0407272BA 8D0407272AP 8D0407452P 8D0407452X	← Lungh. Tot. = 635 mm → Ø 100 Cave 33	
LATO SX AU 00113			AU 00114 LATO DX	
NOTE ABS 45D				



A4	2.8 V6 128Kw 2.8 V6 142Kw	95>00 95>97	2.6 V6 110Kw 2.5 TDI 110Kw	94>00 97>00
	RIFERIMENTI ORIGINALI			
← Lungh. Tot. = 602 mm → Cave 38 Ø 130	8D0407271AH 8D0407271DT	8D0407272DT 8D0407452EV	← Lungh. Tot. = 623 mm → Ø 130 Cave 38	
LATO SX AU 00134			AU 00135 LATO DX	
NOTE ABS 45D				

A4	1.9 TDI 85Kw 1.8 T 120Kw	04>08 03>08	2.0 TFSI 147/162Kw 2.0 TDI 100/103/125Kw	04>08 06>08	2.5 TDI 114/120/132Kw 3.0 TDI 150Kw	2002> 04>08
	RIFERIMENTI ORIGINALI					
← Lungh. Tot. = 600 mm → Cave 38 Fori Ø10mm Int.Forì 104	8E0407271AT 8E0407271S 8E0407451GX 8E0407451JX	8E0407272AT 8E0407272S 8E0407452GX 8E0407452JX	← Lungh. Tot. = 618 mm → Fori Ø10mm Int.Forì 104 Cave 38			
LATO SX AU 00144			AU 00145 LATO DX			
NOTE ABS 45D						



A4	1.8 T 110Kw 1.8 T4 110/120/140Kw	00>02 00>09	2.0 96Kw 2.0 FSI 110Kw	00>04 02>04	2.5 TDI 114/120/152Kw 3.0 162Kw	02>05
	RIFERIMENTI ORIGINALI					
← Lungh. Tot. = 596 mm → Cave 38 Ø 130	8E0407271AH 8E0407271AR	8E0407272AH 8E0407272AR	← Lungh. Tot. = 617 mm → Ø 130 Cave 38			
LATO SX AU 00172			AU 00173 LATO DX			
NOTE ABS 45D						

A4		1.8 TFSI 88/118Kw 2.0 TFI 132/155	2007> 11/2007>	2.0 TDI 88/100/105/120/125Kw 3.0 TDI 176Kw	3.2 TFI 195Kw	08>12
		RIFERIMENTI ORIGINALI				
← Lungh. Tot. = 500 mm → Cave 42 Ø 123		8K0407271D 8K0407271Q 8K0407451AV		← Lungh. Tot. = 500 → Ø 123 Cave 42		
LATO SX AU 00182				AU 00182 LATO DX		



NOTE

A4		1.8 TFSI 118/125Kw 2.0 TFSI 105/118/125/132/155Kw	2007>	2.7 TDI 140Kw 3.0 TDI 176Kw	2007> 2009>	3.2 TFSI 195Kw	2005>
		RIFERIMENTI ORIGINALI					
← Lungh. Tot. = 465 mm → Cave 42 Ø 123		8K040727AJ 8K0407451LX		← Lungh. Tot. = 465 mm → Ø 123 Cave 42			
LATO SX AU 00183				AU 00183 LATO DX			



NOTE 18213180

A4 C/AUT.		2.5 TDI 120Kw C/A 2.8 128 C/A				
		RIFERIMENTI ORIGINALI				
← Lungh. Tot. = 530 mm → Cave 38 Ø 130		1K0407271DA		1K0407272HB		
LATO SX AU 00148				AU 00149 LATO DX		



NOTE

A4 C/AUT.		1.8 T4 120/140Kw 2.5 TDI 132Kw	02>04 00>04	3.0 160/162	00>04	
		RIFERIMENTI ORIGINALI				
← Lungh. Tot. = 517 mm → Cave 38 Ø 130		8E0407271AA		8E0407272AA		
LATO SX AU 00148				AU 00149 LATO DX		



NOTE

A5	1.8 TFSI 118/125Kw 2.0 TDI 105/125Kw	2009> 2.0 TFSI 132/155Kw 2009> 3.0 TDI 176Kw	2008> 3.2 FSI 195Kw 2007>	2009>
	RIFERIMENTI ORIGINALI			
← Lungh. Tot. = 500 mm → Cave 42 Ø 123			← Lungh. Tot. = 500 mm → Ø 123 Cave 42	
LATO SX AU 00182			AU 00182 LATO DX	



NOTE

A5	1.8 TFSI 118/125Kw 2.0 TFSI 105/118/125/132/155Kw	2007> 2.7 TDI 140Kw 3.0 TDI 176Kw	2007> 3.2 TFSI 195Kw 2009>	2005>
	RIFERIMENTI ORIGINALI			
← Lungh. Tot. = 465 mm → Cave 42 Ø 123	8K040727AJ 8K0407451LX		← Lungh. Tot. = 465 mm → Ø 123 Cave 42	
LATO SX AU 00183			AU 00183 LATO DX	

NOTE 18213180

A6	2.0 74/85Kw 2.3 98Kw	1994> 2.0 16v 103Kw 1994> 2.0 V6 110Kw	1994>	
	RIFERIMENTI ORIGINALI			
← Lungh. Tot. = 623 mm → Cave 38 Ø 108	4A0407272AS 4A0407272CR	4A0407272D	← Lungh. Tot. = 662 mm → Ø 108 Cave 38	
LATO SX AU 00119			AU 00120 LATO DX	

NOTE ABS 45D

A6	2.0 TFSI 125Kw 2.0 TDI 100/103/125Kw	05>11 2.7 TDI 120/132/140Kw 04>11	04>11	
	RIFERIMENTI ORIGINALI			
← Lungh. Tot. = 618 mm → Cave 38 Cave 123	4F0407271G	4F0407272G	← Lungh. Tot. = 655 mm → Cave 123 Cave 38	
LATO SX AU 01004			AU 01005 LATO DX	

NOTE

A6

2.0 TDI 89/100/103/125Kw C/A
04>11

ra:di:ni.srl

← Lungh. Tot. = 550 mm →
Cave 38 Cave 123

LATO SX

AU 01006

RIFERIMENTI ORIGINALI

4F0407271N

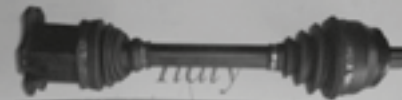
4F0407452CX
4F0407272N

ra:di:ni.srl

← Lungh. Tot. = 485 mm →
Cave 123 Cave 38

AU 01007

LATO DX

NOTE

A6

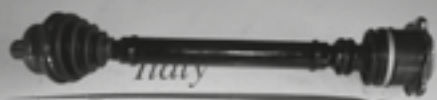
2.5 TDI 85/103Kw
2.8 V6 128Kw94>97
95>97

ra:di:ni.srl

← Lungh. Tot. = 615 mm →
Cave 38 Ø 130

LATO SX

AU 00121

RIFERIMENTI ORIGINALI

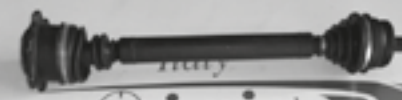
443407271BH
447407271
447407271D4A0407272BH
4A0407272DC
4A0407272DE

ra:di:ni.srl

← Lungh. Tot. = 651 mm →
Ø 130 Cave 38

AU 00122

LATO DX

NOTE ABS 45D

A6

1.9 TDI 81Kw
2.4 115/121Kw1997>
1997>2.5 TDI 110Kw
2.7 T 169Kw1997>
1999>

2.8 142Kw

1997>

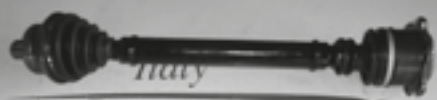

ra:di:ni.srl

← Lungh. Tot. = 623 mm →
Cave 38 Ø 130

LATO SX

AU 00136

RIFERIMENTI ORIGINALI

4B0407271C

4B0407272C

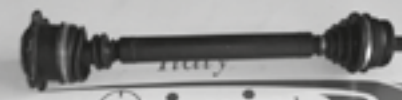

ra:di:ni.srl

← Lungh. Tot. = 640 mm →
Ø 130 Cave 38

AU 00137

LATO DX

NOTE ABS 45D

A6

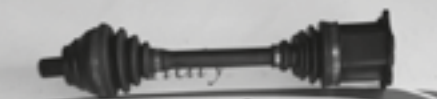
2.5 TDI 120Kw
S6 250Kw02>05
1999>

ra:di:ni.srl

← Lungh. Tot. = 540 mm →
Cave 38 Fori Ø10mm Int.Fori 104

LATO SX

AU 00150

RIFERIMENTI ORIGINALI

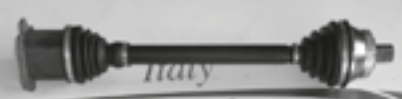
4B3407271B
4B3407271G4B3407272C
4B3407272H



ra:di:ni.srl

← Lungh. Tot. = 480 mm →
Fori Ø10mm Int.Fori 104 Cave 38



AU 00151

LATO DX



NOTE ABS 45D

A6 ALLROAD 2.7 - 3.0 Aut. 00>05		RIFERIMENTI ORIGINALI	
			
← Lungh. Tot. = 540 mm → Cave 38 Fori Ø10mm Int.Forì 104			← Lungh. Tot. = 505 mm → Fori Ø10mm Int.Forì 104 Cave 38
LATO SX AU 00185			AU 00186 LATO DX

NOTE

A8 2.8 V6 2.5 TDI 1994>2002 S 8 250kw 1997>2002 < 2002		RIFERIMENTI ORIGINALI	
	4D0407271F 4D0407271K	4D0407272F 4D0407272K	
← Lungh. Tot. = 632 mm → Cave 38 Ø 130			← Lungh. Tot. = 672 mm → Ø 130 Cave 38
LATO SX AU 00123			AU 00124 LATO DX

NOTE ABS 45D

A8 3.2 206Kw 4.0 TDI 202Kw 02>10 02>10 4.2 246Kw 02>10		RIFERIMENTI ORIGINALI	
	4E0407270N	4E0407271N	
← Lungh. Tot. = 480 mm → Cave 38 Int. forì 104			← Lungh. Tot. = 560 mm → Int. forì 104 Cave 38
LATO SX AU 00189			AU 00190 LATO DX

NOTE

Q3 1.4 TFSI 110Kw 2.0 TDI 103Kw 2013> 2011> 2.0 TDI 135Kw 2014>		RIFERIMENTI ORIGINALI	
	5N0407761Q 5N0407761QX 5N0407763A 5N0407763AX	5N0407766B 5N0407762F	
← Lungh. Tot. = 495 mm → Cave 36 Cave int. 40			← Lungh. Tot. = 795 mm → Cave 108 Cave 36
LATO SX AU 01004			AU 01005 LATO DX

NOTE

Q3

1.4 TFSI 110Kw
2.0 TFSI 132Kw2011> | 2.0 TDI 88/100/110/130/135Kw
2011>← Lungh. Tot. = 490 mm →
Cave 36 Ø 108

LATO SX

VW 00162

RIFERIMENTI ORIGINALI

1K0407271BJ

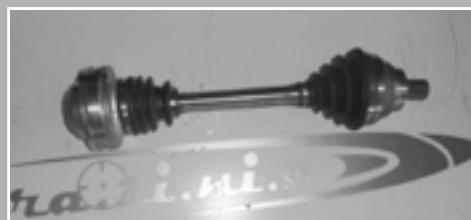
5N0407766BX
5N0407766B← Lungh. Tot. = 803 mm →
Ø 108 Cave 36

VW 00174

LATO DX

NOTE

Q5

2.0 TDI 100/105/125Kw
2.0 TFSI 132/135Kw2010> |
2008>← Lungh. Tot. = 490 mm →
Cave 42 Ø 123

LATO SX

AU 01008

RIFERIMENTI ORIGINALI

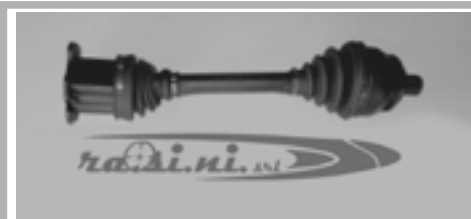
8R0407271
8R0407271B
8R0407271BX← Lungh. Tot. = 490 mm →
Ø 123 Cave 42

AU 01008

LATO DX

NOTE

Q5

2.0 TFSI 155Kw
2.0 TDI 125Kw2001> | 2.8 FSI 150Kw
2008> | 3.0 TDI 176Kw2011> | 3.2 FSI 199Kw
2008>

2008>

← Lungh. Tot. = 495 mm →
Cave 42 Ø 123

LATO SX

AU 01007

RIFERIMENTI ORIGINALI

8R0407271CX
8R0407271IC
8R0407271IA← Lungh. Tot. = 495 mm →
Ø 123 Cave 42

AU 01007

LATO DX

NOTE

Q7

← Lungh. Tot. = 525 mm →
Cave 30 Cave 112

LATO SX

VW 01010

RIFERIMENTI ORIGINALI

7P0407271C
7P0407271B
7P0407271A← Lungh. Tot. = 525 mm →
Cave 112 Cave 30

VW 01010



LATO DX

NOTE Fonico Ø 64

Serie 1	116 I 118 I	09/04>05/11 09/04>05/11	118 D 120 I	09/04>05/11 09/04>05/11
	RIFERIMENTI ORIGINALI			
← Lungh. Tot. = 635 mm Cave 27 Ø 92 →	33217547069	33217547070	← Lungh. Tot. = 670 mm Ø 92 Cave 27 →	
LATO SX BW 00123			BW 00124 LATO DX	
NOTE ABS 48D				

Serie 1	120 D	09/04>05/11	
	RIFERIMENTI ORIGINALI		
← Lungh. Tot. = 615 mm Cave 27 Ø 102 →	33217547075	33217547076	← Lungh. Tot. = 670 mm Ø 102 Cave 27 →
LATO SX BW 00125			BW 00126 LATO DX
NOTE ABS 48D			

Serie 3 E36	316 I 73/75Kw	1990>	318 I - I Tour-TDS Tour 66/85Kw	1995>	320 I-I Tour 119Kw	1995>
	RIFERIMENTI ORIGINALI					
← Lungh. Tot. = 625 mm Cave 27 Ø 94 →	33211227032 33211227172 33211227606				← Lungh. Tot. = 625 mm Ø 94 Cave 27 →	
LATO SX BW 00101 - BW 00101/A*					BW 00101 - BW 00101/A* LATO DX	
NOTE ABS 48D						

Serie 3 E36	325 I-Cabrio-Coupe-TD 141Kw	1990>	325 TDS 85Kw	1993>
	RIFERIMENTI ORIGINALI			
← Lungh. Tot. = 614 mm Cave 27 Ø 100 →	33211226905* 33211229472* 33211229473*			← Lungh. Tot. = 614 mm Ø 100 Cave 27 →
LATO SX BW 00102 - BW 00102/A*				BW 00102 - BW 00102/A LATO DX
NOTE ABS 48D				

Serie 3 E46	316 75/85Kw 318 87/105Kw	1998> 320 110/125Kw 1998>	1998>
	RIFERIMENTI ORIGINALI		
← Lungh. Tot. = 625 mm → Cave 27 Ø 94	33211229578	33211229588	← Lungh. Tot. = 680 mm → Ø 94 Cave 27
LATO SX BW 00121			BW 00122 LATO DX
NOTE ABS 48D			

Serie 3 E46	318 D 85Kw 320 100/110Kw	2001> 323 125Kw 1998> 325 141Kw	1998> 328 142Kw 2000>	1998>
	RIFERIMENTI ORIGINALI			
← Lungh. Tot. = 620 mm → Cave 27 Ø 100	33211229591 33211229707 33217518431	33211229592 33211229708 33217518432	← Lungh. Tot. = 680 mm → Ø 100 Cave 27	
LATO SX BW 00119			BW 00120 LATO DX	
NOTE ABS 48D				

Serie 3 E46	330 XD 135/150Kw 330 XI 170Kw	2000> 325 XI 141Kw 2000>	2000>
	RIFERIMENTI ORIGINALI		
← Lungh. Tot. = 582 mm → Cave 30 Cave 27	31607502731 31607505199	31607502732 31607505200	← Lungh. Tot. = 902 mm → Cave 27 Cave 30
LATO SX BW 00112	Fusello L/C 60mm	Fusello L/C 382mm	BW 00113 LATO DX
NOTE Fonico Ø 59			

Serie 3 E90	316 85/90Kw 318 100Kw	01/05>09/11 01/05>09/11	
	RIFERIMENTI ORIGINALI		
← Lungh. Tot. = 615 mm → Cave 27 Ø 93	33217553561	33217553562	← Lungh. Tot. = 670 mm → Ø 93 Cave 27
LATO SX BW 00123			BW 00124 LATO DX
NOTE			

Serie 3 E90		318 D 90/100/105Kw 320 D 120/130/135	01/05>09/11 01/05>09/11	
RIFERIMENTI ORIGINALI				
 ← Lungh. Tot. = 615 mm → Cave 27 Ø 100		33217561783	33217547076	 ← Lungh. Tot. = 670 mm → Ø 100 Cave 27
LATO SX BW 00125				BW 00126 LATO DX

NOTE

Serie 5		518 75/77Kw 520 92/93Kw	89>95 88>95	524 63/85Kw	91>95
RIFERIMENTI ORIGINALI					
 ← Lungh. Tot. = 467 mm → Ø 100 Ø 100				 ← Lungh. Tot. = 467 mm → Ø 100 Ø 100	
LATO SX BW 00108				BW 00108	LATO DX

NOTE

Serie 5		530 155/160Kw 535 185Kw	88>95 88>95	M5 232Kw	88>95
RIFERIMENTI ORIGINALI					
 ← Lungh. Tot. = 458 mm → Ø 108 Ø 108		33211226621 33211226622		33201227221 33211226047	 ← Lungh. Tot. = 458 mm → Ø 108 Ø 108
LATO SX BW 00109					BW 00109 LATO DX

NOTE

Serie 5		525 TDS E39 85Kw 523 D 125/141Kw	1996> 1995>	528 141/142Kw	1995>
RIFERIMENTI ORIGINALI					
 ← Lungh. Tot. = 626 mm → Cave 30 Ø 100		33201229441 33201229449			 ← Lungh. Tot. = 626 mm → Ø 100 Cave 30
LATO SX BW 00107					BW 00107 LATO DX

NOTE

Serie 5

525 XI 145/160Kw
525 XD 145/170Kw05>10
07>10530 XI 160/170/173/190/200Kw
05>10← Lungh. Tot. = 611 mm →
Cave 30 Cave 27

LATO SX

BW 00127

RIFERIMENTI ORIGINALI

31607570275
31607558951
3160757027331607558952
31607570274← Lungh. Tot. = 930 mm →
Cave 27 Cave 30

BW 00128

LATO DX

NOTE ABS 48

X3

2.0 D 110Kw
2.0 I 110Kw2004> 2.5 141Kw
2004> 3.0 D 150/160Kw2003> 3.0 I 170Kw
2003>← Lungh. Tot. = 600 mm →
Cave 30 Cave 27

LATO SX

BW 00114

RIFERIMENTI ORIGINALI

31607524045
3160752920131607521046
31607529202

Fusello L/C 80mm

Fusello L/C 400mm

← Lungh. Tot. = 920 mm →
Cave 27 Cave 30

BW 00115

LATO DX

NOTE Fonico Ø 65

X3

2011>

← Lungh. Tot. = 593 mm →
Cave 27

LATO SX

BW 00130

RIFERIMENTI ORIGINALI

Fusello L/C 375mm

← Lungh. Tot. = 878 mm →
Cave 27

BW 00131

LATO DX

NOTE ABS 37 Ø 64

X5

3.0 I 163/170Kw
3.0 D 135/160Kw2001> 4.4 I 210/235Kw
2000> 4.6 I 255Kw2000> 4.8 I 265Kw
2002>

2004>

← Lungh. Tot. = 590 mm →
Cave 30 Cave 27

LATO SX

BW 00116

RIFERIMENTI ORIGINALI

31607505003
3160750500531607505004
31607505006

Fusello L/C 64mm

Fusello L/C 448mm

← Lungh. Tot. = 975 mm →
Cave 27 Cave 30

BW 00117

LATO DX

NOTE Fonico Ø 65

X5	2996 200Kw 4.4 261Kw	07>08 4.8 261Kw 2009>	2008>
	RIFERIMENTI ORIGINALI		
← Lungh. Tot. = 637 mm → Cave 30 Cave 27	31607545125	31607545126	← Lungh. Tot. = 1020 mm → Cave 27 Cave 30
LATO SX BW 00135			BW 00136 LATO DX

NOTE

X6	3.0 173Kw 4.4	2008> 2008>	
	RIFERIMENTI ORIGINALI		
← Lungh. Tot. = 637 mm → Cave 30 Cave 27	31607545125	31607545126	← Lungh. Tot. = 1020 mm → Cave 27 Cave 30
LATO SX BW 00135			BW 00136 LATO DX

NOTE

Z4	2.5 141Kw 2.5 Aut. 141Kw	2003> 3.0 170Kw 2003> 3.0 Aut. 170Kw	2003> 2003>
	RIFERIMENTI ORIGINALI		
← Lungh. Tot. = 620 mm → Cave 27 Ø 100	33211229591 33211229707 33217518431	33211229592 33211229708 3321758432	← Lungh. Tot. = 680 mm → Ø 100 Cave 27
LATO SX BW 00119			BW 00120 LATO DX

NOTE ABS 48D

	RIFERIMENTI ORIGINALI		
←			→
LATO SX			LATO DX

NOTE

PT Cruiser

1.6 55Kw
2.0 100/104Kw2000>
2000>← Lungh. Tot. = 595 mm →
Cave 26 Cave 25

LATO SX

CH 00107

RIFERIMENTI ORIGINALI

04668421AB
04668919AA04668420AB
04668420AC
04668918AA← Lungh. Tot. = 950 mm →
Cave 25 Cave 26

CH 00108

LATO DX

NOTE ABS 46

PT Cruiser

2.2 CRD 89/110Kw

2002>

← Lungh. Tot. = 557 mm →
Cave 26 Cave 28

LATO SX

CH 00111

RIFERIMENTI ORIGINALI

5274807AB

5274806AB

← Lungh. Tot. = 492 mm →
Cave Int. Cave 26

CH 00112

LATO DX

NOTE ABS 47D

CH 00112/M Completo di innesto

Voyager

2.5 SE-SE II 72/74Kw
3.0 I 100/103/108Kw84>90
84>90

3.3 I 110/112/120Kw

84>90

← Lungh. Tot. = 615 mm →
Cave 26 Cave 25

LATO SX

CH 00101

RIFERIMENTI ORIGINALI

D302823

4511436
4511438← Lungh. Tot. = 1002 mm →
Cave 25 Cave 26

CH 00102

LATO DX

NOTE

Voyager

2.5 TD
2.5 I92>95
91>953.0 I
3.3 I91>95
91>95← Lungh. Tot. = 655 mm →
Cave 26 Cave 25

LATO SX

CH 00103 - CH 00103/A

RIFERIMENTI ORIGINALI



A = ABS 47



← Lungh. Tot. = 1008 mm →
Cave 25 Cave 26

CH 00104 - CH 00104/A

LATO DX

NOTE ABS 47D su richiesta

Voyager		2.0 I 2.4 2.5 TD	95>01 2.5 CRD 105Kw	2000>
 <p>← Lungh. Tot. = 640 mm → Cave 26 Cave 25</p>	RIFERIMENTI ORIGINALI		 <p>← Lungh. Tot. = 1030 mm → Cave 25 Cave 26</p>	
	04641883AE 4641883AA	04641884AD 04641884AE 4641884AA		
LATO SX	CH 00105		CH 00106	LATO DX
NOTE ABS 47D				

Voyager		2.5 CRD 88/105Kw 2.8 CRD 110Kw	2001>	2004>
 <p>← Lungh. Tot. = 640 mm → Cave 26 Cave 27</p>	RIFERIMENTI ORIGINALI		 <p>← Lungh. Tot. = 1030 mm → Cave 27 Cave 26</p>	
	4808883			
LATO SX	CH 00109		CH 00110	LATO DX
NOTE ABS 47D				

 <p>← →</p>	RIFERIMENTI ORIGINALI		 <p>← →</p>	
LATO SX				LATO DX
NOTE				

 <p>← →</p>	RIFERIMENTI ORIGINALI		 <p>← →</p>	
LATO SX				LATO DX
NOTE				

AX

1.0 E Special Escapade 30Kw
1.3 Sport 70Kw86>
86>1.1 I Te-Tge-First-Re-Tre-Tge-Club
40/44Kw

86>

1.4 Diesel Rd-Trd-Tgd-Trs-Tzs
Club-Gt 38/44/49Kw

86>

← Lungh. Tot. = 617 mm →
Cave 21 Cave 22

LATO SX

CI 00101

RIFERIMENTI ORIGINALI

95648547
96033355
96042491
9660186895601867
95601887
96033369
96042942← Lungh. Tot. = 800 mm →
Cave 22 Cave 21

CI 00102

LATO DX

NOTE Cerchio 3 bulloni

AX

1.4 D 38Kw
1.4 62/65Kw1986>
1986>1.4 GTI 69/74Kw
1.5 D 42/43Kw1986>
1986>← Lungh. Tot. = 614 mm →
Cave 21 Cave 22

LATO SX

PE 00103 - PE 00103/A

RIFERIMENTI ORIGINALI

32721K
95666908
9566694032730K
32735K
95666941

A = ABS 48

← Lungh. Tot. = 798 mm →
Cave 22 Cave 21

PE 00104 - PE 00104/A

LATO DX

NOTE Cerchio 4 bulloni

Berlingo

1.1 40/44Kw
1.4 Berlingo 55Kw1996>
1996>

1.6 I 65Kw

97>00

← Lungh. Tot. = 594 mm →
Cave 25 Cave 22

LATO SX

CI 00105 - CI 00105/A*

RIFERIMENTI ORIGINALI

32725L
3272Y6
3272Y7
3272Z2*32730W
32730XFusello L/C 58mm
A = ABS 29

A = ABS 29

← Lungh. Tot. = 860 mm →
Cave 22 Cave 25

CI 00106 - CI 00106/A*

LATO DX

NOTE

Berlingo

1.6 16v 80Kw
1.8 66Kw2000>
1996>1.8 D 43/44Kw
1.9 D 47/48Kw

1996>

← Lungh. Tot. = 594 mm →
Cave 25 Cave 24

LATO SX

CI 00107 - CI 00107/A*

RIFERIMENTI ORIGINALI

32729L
3272Y3
3272Z8*
3272Z7*

32736J

A = ABS 29



A = ABS 29



← Lungh. Tot. = 865 mm →
Cave 24 Cave 25



CI 00108 - CI 00108/A*



LATO DX

NOTE

Berlingo	1.6 16v 80Kw 1.6 HDI 55/66Kw	2000> 2.0 HDI 66Kw 2005>	1999>
	RIFERIMENTI ORIGINALI		
← Lungh. Tot. = 585 mm → Cave 25 Cave 24	32721S 32722S 3272FQ	32730S 32737W 32730T 32739Z*	← Lungh. Tot. = 872 mm → Cave 24 Cave 25
LATO SX	Fusello L/C 62mm A = ABS 29	A = ABS 29	LATO DX
CI 01014 - CI 01014/A*		CI 01015 - CI 01015/A*	
NOTE ABS 29D su richiesta			

Berlingo	1.6 HDI 55/66/80Kw	2005>	
	RIFERIMENTI ORIGINALI		
← Lungh. Tot. = 585 mm → Cave 25 Cave 24	3272FG 3272FH 3272LP 3272LQ	3273JY	← Lungh. Tot. = 875 mm → Cave 24 Cave 25
LATO SX	Fusello L/C 62mm		LATO DX
CI 01016			CI 01017
NOTE ABS 48D Ø90			

Berlingo	1.6 HDI 68/80Kw	07/2010>	
	RIFERIMENTI ORIGINALI		
← Lungh. Tot. = 623 mm → Cave 25 Cave 24	32721X 32722X 3272LW	3273AC 3273AE 3273LP	← Lungh. Tot. = 929 mm → Cave 24 Cave 25
LATO SX	Fusello L/C 62mm		LATO DX
CI 01003			CI 01004
NOTE Fonico Ø 59			

BX	1.1 40/42Kw 1.4 52/53Kw	82>88 82>88	
	RIFERIMENTI ORIGINALI		
← Lungh. Tot. = 741 mm → Cave 25 Cave 22	95602248 95606802 95619478		← Lungh. Tot. = 741 mm → Cave 22 Cave 25
LATO SX			LATO DX
CI 00182			CI 00182
NOTE			

BX

1.1 40/42Kw
1.4 55Kw88>91
88>91← Lungh. Tot. = 600 mm →
Cave 25 Cave 22

LATO SX

CI 00109

RIFERIMENTI ORIGINALI

95640036

95640053

← Lungh. Tot. = 858 mm →
Cave 22 Cave 25

CI 00110

LATO DX

NOTE

BX

1.5 RE-TGE 58/59Kw
1.6 RS-TRS-TGS 66/67Kw86> | 1.9 D-TRD-TZD-GT-TRS-TRI
82> | 47/48/50/51/75Kw

1982> | 1.7 D RD 43/44Kw

1982>

← Lungh. Tot. = 592 mm →
Cave 25 Cave 24

LATO SX

CI 00111

RIFERIMENTI ORIGINALI

95602338
95606396
9561947995602241
95606797← Lungh. Tot. = 865 mm →
Cave 24 Cave 25

CI 00112

LATO DX

NOTE

BX

1.8 TD 66Kw
1.9 GTI 90/116Kw1986> |
1986> |← Lungh. Tot. = 592 mm →
Cave 25 Cave 24

LATO SX

CI 00113 - /A* - /B°

RIFERIMENTI ORIGINALI

3272A9
3272Y4*
3273K2*
9617185632730S*
3273K4
96167304
96171875*A = ABS 29
B = ABS 90← Lungh. Tot. = 865 mm →
Cave 24 Cave 25

CI 00114 - /A* - /B°

LATO DX

NOTE

C1

1.0 50Kw

2005> |

← Lungh. Tot. = 650 mm →
Cave 24 Cave 23

LATO SX

CI 00197



RIFERIMENTI ORIGINALI



3272JY
934200H0103273JR
434100H010← Lungh. Tot. = 840 mm →
Cave 23 Cave 24



CI 00198



LATO DX



NOTE Fonico Ø 49,4

C1	1.4 HDI 40Kw	2005>		
 <p>← Lungh. Tot. = 595 mm → Cave 24 Cave 23</p> <p>LATO SX CI 01001</p>	RIFERIMENTI ORIGINALI		 <p>← Lungh. Tot. = 896 mm → Cave 23 Cave 24</p> <p>CI 01002 LATO DX</p>	
	3272JZ 434200H020	3273JS 434100H020		
NOTE Fonico Ø 49,4				



C1	1.0 VTI 51/68Kw	2014>		
 <p>← Lungh. Tot. = 795 mm → Cave 22 Cave 24</p> <p>LATO SX CI 01117</p>	RIFERIMENTI ORIGINALI		 <p>← Lungh. Tot. = 795 mm → Cave 22 Cave 24</p> <p>CI 01118 LATO DX</p>	
	Fusello L/C 97mm			
NOTE				

C2 - C3	C2 1.1 44Kw C2 1.4 54Kw	2003> 2003>	C3 1.1 44Kw C3 1.4 55Kw	2002> 2002>	C3 Pluriel 1.4 54Kw	2003>
 <p>← Lungh. Tot. = 649 mm → Cave 21 Cave 22</p> <p>LATO SX CI 00103</p>	RIFERIMENTI ORIGINALI		 <p>← Lungh. Tot. = 845 mm → Cave 22 Cave 21</p> <p>CI 00104 LATO DX</p>			
	3272EN 3272EP 3272FW 3272FX	3273EA 3273EN 3273EP				
NOTE						



C2 - C3	C3 1.4 16v 65Kw C3 1.6 16v 80Kw	2002> 2002>	C2 1.4 16v 65Kw C2 1.6 16v 80Kw	2006> 2003>	C2 1.6 VTS 90Kw C3.Pluriel 1 6 80Kw	2005> 2003>
 <p>← Lungh. Tot. = 645 mm → Cave 21 Cave 22</p> <p>LATO SX CI 00187</p>	RIFERIMENTI ORIGINALI		 <p>← Lungh. Tot. = 845 mm → Cave 22 Cave 21</p> <p>CI 00188 LATO DX</p>			
	3272HR 3272JA 3272JC 3272RT 9650624280	3273HH 3273SG		Fusello L/C 58mm Fusello L/C 97mm		
NOTE						

C2 - C3	C2 1.4 HDI 50Kw C3 1.4 HDI 50Kw	2003> 2002>	C3 1.4 HDI Aut. 50Kw	2002>
RIFERIMENTI ORIGINALI				
	3272JA 3272JC 3272ES 3272ET		3273HS 3273HT	
← Lungh. Tot. = 640 mm → Cave 21 Cave 22	Fusello L/C 58,5mm		Fusello L/C 97mm	← Lungh. Tot. = 850 mm → Cave 22 Cave 21
LATO SX	CI 00183			CI 00184 LATO DX



NOTE

C3	1.4 HDI 66Kw 16v 1.6 HDI 66/80Kw	2002> 2005>		
RIFERIMENTI ORIGINALI				
	3272EX 9641777180		3273EX 9639508780	
← Lungh. Tot. = 635 mm → Cave 21 Cave 24	Fusello L/C 290mm			← Lungh. Tot. = 860 mm → Cave 24 Cave 21
LATO SX	CI 00185			CI 00186 LATO DX



NOTE

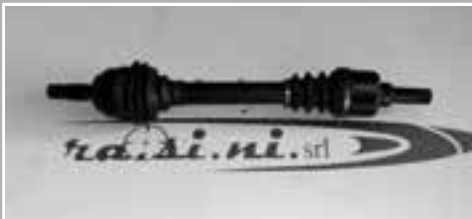

C3 - C3 Picasso	1.6 HDI 55/73/80Kw 1.6 HDI 66/68/80Kw	2008> 2009>		
RIFERIMENTI ORIGINALI				
	3272LG 3272LH		3273KR 3273KS	
← Lungh. Tot. = 635 mm → Cave 25 Cave 24	Fusello L/C 62mm		Fusello L/C 290mm	← Lungh. Tot. = 860 mm → Cave 24 Cave 25
LATO SX	PE 01126			PE 01127 LATO DX



NOTE ABS 48



C4	1.4 16v 65Kw 1.6 16v 80Kw	2004> 2004>		
RIFERIMENTI ORIGINALI				
	32725X 32726X		3273AH 3273AJ	
← Lungh. Tot. = 640 mm → Cave 25 Cave 22	Fusello L/C 58mm			← Lungh. Tot. = 925 mm → Cave 22 Cave 25
LATO SX	CI 01050			CI 01051 LATO DX

NOTE Fonico Ø 58,7

C4		1.6 HDI 16v 66/80Kw 2.0 16v 80 kw	2004> 2004>				
 <p>← Lungh. Tot. = 623 mm → Cave 25 Cave 24</p> <p>LATO SX CI 01003</p>	RIFERIMENTI ORIGINALI		 <p>← Lungh. Tot. = 929 mm → Cave 24 Cave 25</p> <p>CI 01004 LATO DX</p>	<p>32721X 32722X 3272LW</p> <p>Fusello L/C 62mm</p>		<p>3273AC 3273AE 3273LP</p>	
	<p>NOTE Fonico Ø 59</p>						

C4		2.0 HDI 100Kw/103Kw	2004>2011				
 <p>← Lungh. Tot. = 616 mm → Cave 25 Cave 37</p> <p>LATO SX CI 01005</p>	RIFERIMENTI ORIGINALI		 <p>← Lungh. Tot. = 950 mm → Cave 37 Cave 25</p> <p>CI 01006 LATO DX</p>	<p>3272FT 9645219080</p> <p>Fusello 69mm</p>		<p>3273CY 9645219180</p> <p>Fusello 399mm</p>	
	<p>NOTE</p>						

C4 - Picasso		1.4 16V 65Kw 1.6 HDI 65/80/110/115kw	04>11 06>13	C4 II 1.6 HDI 84Kw C4 Picasso 1.6 16V	04>11 08>13	C4 Picasso 1.6 HDI 80/82Kw G/Picasso 1.6 HDI 80/82/110/115Kw	07>13 08>
 <p>← Lungh. Tot. = 615 mm → Cave 25 Cave 24</p> <p>LATO SX CI 01010</p>	RIFERIMENTI ORIGINALI		 <p>← Lungh. Tot. = 938 mm → Cave 24 Cave 25</p> <p>CI 01011 LATO DX</p>	<p>3272LX 3272ZE</p> <p>L/C.70mm</p>		<p>3273LR</p>	
	<p>NOTE</p>						

C5		1.6 MDI 80Kw 1.8 16v 85Kw	2004> 01>04	2016v 103Kw	04>		
 <p>← Lungh. Tot. = 655 mm → Cave 25 Cave 24</p> <p>LATO SX CI 00189</p>	RIFERIMENTI ORIGINALI		 <p>← Lungh. Tot. = 935 mm → Cave 24 Cave 25</p> <p>CI 00190 LATO DX</p>	<p>32724T 32725T</p> <p>L/C.70mm</p>		<p>32738G 32738H</p>	
	<p>NOTE Fonico Ø 58,5</p>						

C5

2.0 16v 100Kw
2.0 HDI 103Kw01>04
01>04← Lungh. Tot. = 645 mm →
Cave 25 Cave 24

LATO SX

CI 00191

RIFERIMENTI ORIGINALI

32726T
32727T32738G
32738H

Fusello L/C 62mm

← Lungh. Tot. = 935 mm →
Cave 24 Cave 25

CI 00190

LATO DX

NOTE Fonico Ø 58,5

C5

1.8 16V
2.0 HDI 80Kw

01>04 | 3.0 I 152Kw

01>04

← Lungh. Tot. = 638 mm →
Cave 25 Cave 37

LATO SX

CI 00173

RIFERIMENTI ORIGINALI

32722V
3272EJ32738J
32738P

Fusello L/C 69mm

Fusello L/C 361mm

← Lungh. Tot. = 945 mm →
Cave 37 Cave 25

CI 00174

LATO DX

NOTE Fonico Ø 58,5

C5

2.2 HDI 98Kw C/A
2.2 HDI.98Kw C/A01>04
2004>← Lungh. Tot. = 625 mm →
Cave 25 Cave 37

LATO SX

CI 00175

RIFERIMENTI ORIGINALI

32726V

32738T

Fusello L/C 69mm

Fusello L/C 337mm

← Lungh. Tot. = 946 mm →
Cave 37 Cave 25

CI 00176

LATO DX

NOTE Fonico Ø 58,5

C5

2.2 HDI 98Kw

01>04

← Lungh. Tot. = 625 mm →
Cave 25 Cave 37

LATO SX

CI 01115

RIFERIMENTI ORIGINALI

3272EH
3272RC
3272RA3273EH
3273NY



L/C370

← Lungh. Tot. = 948 mm →
Cave 37 Cave 25

CI 01116

LATO DX



NOTE

<p>C5</p> <p>3.0 V6 152Kw C/A 3.0 173Kw C/A</p> <p>01>04 03>04 </p>	<p>RIFERIMENTI ORIGINALI</p>		 <p>Lungh. Tot. = 918 mm ← Cave 37 → Cave 25</p> <p>CI 01114 LATO DX</p>
	 <p>Lungh. Tot. = 603 mm ← Cave 25 → Cave 37</p> <p>CI 01113 LATO SX</p>	<p>3272EL</p> <p>3273EL 32738R 32738S</p> <p>Fusello L/C 390mm</p>	

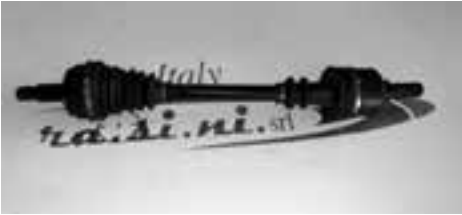

NOTE

<p>C6</p> <p>2.2 HDI 120/125 Kw</p> <p>2006> </p>	<p>RIFERIMENTI ORIGINALI</p>		 <p>Lungh. Tot. = 1000 mm ← Cave 37 → Cave 28</p> <p>CI 01060 LATO DX</p>
	 <p>Lungh. Tot. = 670 mm ← Cave 28 → Cave 37</p> <p>CI 01059 LATO SX</p>	<p>3272QT</p> <p>3273JW</p> <p>L/C 400</p>	

NOTE

<p>C8</p> <p>2.0 HDI 79Kw</p> <p>2002> </p>	<p>RIFERIMENTI ORIGINALI</p>		 <p>Lungh. Tot. = 965 mm ← Cave 37 → Cave 27</p> <p>CI 01008 LATO DX</p>
	 <p>Lungh. Tot. = 645 mm ← Cave 27 → Cave 37</p> <p>CI 01007 LATO SX</p>	<p>3272GY 3272RL</p> <p>3273GQ 3273TF</p> <p>Fusello 69mm Fusello 369mm</p>	

NOTE

<p>C8</p> <p>2.0 HDI 79/80Kw 2.2 116Kw</p> <p>03>10 02> </p>	<p>RIFERIMENTI ORIGINALI</p>		 <p>Lungh. Tot. = 968 mm ← Cave 37 → Cave 27</p> <p>LA 00161 LATO DX</p>
	 <p>Lungh. Tot. = 642 mm ← Cave 27 → Cave 37</p> <p>LA 00160 LATO SX</p>	<p>3272AW 3272GZ</p> <p>3273AY 3273GR</p> <p>L/C.354</p>	

NOTE

C8

2.0 JTD 88Kw
2.0 DM JTD 100Kw06>10
06>10← Lungh. Tot. = 642 mm →
Cave 27 Cave 37

LATO SX

LA 00160

RIFERIMENTI ORIGINALI

3272AW
3272GY
3272GZ3273PS
3273RY
3273RZ

Fusello L/C 383mm

← Lungh. Tot. = 970 mm →
Cave 37 Cave 27

LA 00162

LATO DX

NOTE

C15

1.0 33Kw
1.1 35/44Kw1986> | 1.4 49Kw
1987>

1987>

← Lungh. Tot. = 575 mm →
Cave 21 Cave 22

LATO SX

CI 00115

RIFERIMENTI ORIGINALI

32723K
3272R3
9564440332735P
3273X8
95644404← Lungh. Tot. = 835 mm →
Cave 22 Cave 21

CI 00116

LATO DX

NOTE

C15

1.1 35Kw
1.31987> | 1.4 44Kw
1987> | 1.8 43/44Kw1987>
1984>← Lungh. Tot. = 564 mm →
Cave 21 Cave 24

LATO SX

CI 00117

RIFERIMENTI ORIGINALI

3272R5
327366
9561948132735R
32735S
95591074← Lungh. Tot. = 840 mm →
Cave 24 Cave 21

CI 00118

LATO DX

NOTE

C25

1.8 49/51Kw
2.0 58Kw>1987 | 2.5 D-TD 54/55/70Kw
>1987

>1987

← Lungh. Tot. = 693 mm →
Cave 28 Cave 25

LATO SX

CI 00119



RIFERIMENTI ORIGINALI

327360
3273C7
9559529480← Lungh. Tot. = 1063 mm →
Cave 25 Cave 28



CI 00120

LATO DX



NOTE

C25	1.9 D 50/51Kw	>1987	
	RIFERIMENTI ORIGINALI		
← Lungh. Tot. = 693 mm → Cave 28 Cave 25	9607411480 9559529280 9617303280		← Lungh. Tot. = 1064 mm → Cave 25 Cave 28
LATO SX	CI 00119		CI 00122 LATO DX



NOTE

C25	1.9 D 50/51Kw	1987>	
	RIFERIMENTI ORIGINALI		
← Lungh. Tot. = 702 mm → Cave 28 Cave 25	32727N Fusello 112	327362 32736R 3273C7 327478 96184033 Fusello 112	← Lungh. Tot. = 1068 mm → Cave 25 Cave 28
LATO SX	FI 00125		FI 00126 LATO DX

NOTE

C25	1.8 49/51Kw 2.0 58Kw	1987> 1987>	2.5 D-TD 54/55/70Kw 1987>
	RIFERIMENTI ORIGINALI		
← Lungh. Tot. = 702 mm → Cave 28 Cave 25	327248 327585 96074114 Fusello 112	327362 3273C7 96074111 96184033 Fusello 112	← Lungh. Tot. = 1070 mm → Cave 25 Cave 28
LATO SX	FI 00125		CI 00124 LATO DX

NOTE

Diana	2 CV 4 Dyane 4 2 CV 6 Mehari	1968> 1968>	Dyane 6 17/21Kw 1968>
	RIFERIMENTI ORIGINALI		
← Lungh. Tot. = 440 mm → Cave 22 Cave 12	75525808 95582414		← Lungh. Tot. = 440 mm → Cave 12 Cave 22
LATO SX	CI 00180		CI 00180 LATO DX

NOTE

DS3

1.6 HDI 73Kw

2014>



← Lungh. Tot. = 625 mm →
Cave 25 Cave 24

LATO SX

PE 01022

RIFERIMENTI ORIGINALI

3272LH
3272TZ
3272LG
3272 QA
3272PZ
9660782880

Fusello L/C 62mm

3273VN
3273VP
3272QK
9660782780



← Lungh. Tot. = 945 mm →
Cave 24 Cave 25

PE 01023

LATO DX

NOTE

DS4

1.6 68/88Kw

2011>



← Lungh. Tot. = 625 mm →
Cave 25 Cave 24

LATO SX

PE 01022

RIFERIMENTI ORIGINALI

3272LH
3272TZ
3272LG
3272 QA
3272PZ
9660782880

Fusello L/C 62mm

3273VN
3273VP
3272QK
9660782780



← Lungh. Tot. = 945 mm →
Cave 24 Cave 25

PE 01023

LATO DX

NOTE

Evasion

1.8 Harmonie
D-X-SX 74Kw

96>02

2.0 T CD-SX-VSX 89/90Kw 94>02
2.0 97/100Kw

← Lungh. Tot. = 646 mm →
Cave 27 Cave 24

LATO SX

FI 00120 - FI 00120/A*

RIFERIMENTI ORIGINALI

3272L1*
3272L9
3272L9*
3272M0
3272M0*
3272P5*
9619947588

Fusello L/C 62mm

32735X*
3273T3
3273T4
3273T4*
3273V7*
3273W0*
9619947688

A = ABS 48



← Lungh. Tot. = 930 mm →
Cave 24 Cave 27

FI 00121 - FI 00121/A*

LATO DX

NOTE ABS 48D su richiesta

Evasion

1.9 T-D-X-SX 47Kw
2.0 T CT-SX-VSX 108Kw

1994>

2.1 TD SX-VSX 80Kw
2.0 HDI 80Kw

1994>

99>02



← Lungh. Tot. = 640 mm →
Cave 27 Cave 37

LATO SX

FI 00122 - FI 00122/A

RIFERIMENTI ORIGINALI

32722L*
32723L*
3272K8
3272L0
3272V0*
3272V7*
9617408188

Fusello L/C 69mm

327306*
327307E*
327315*
3273S2
3273S2*
3273S4
9617408288

A = ABS 48
Fusello L/C 369mm

← Lungh. Tot. = 940 mm →
Cave 37 Cave 27



FI 00123 - FI 00123/A

LATO DX

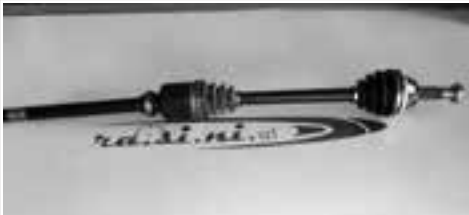
NOTE ABS 48D su richiesta

Jumper	1.9 D 51Kw 1.9 TD 51Kw	94>01 2.0 80Kw 94>01 2.0 HDI 62Kw	94>01 2.5 D 63Kw 2002>	94>01
	RIFERIMENTI ORIGINALI			
← Lungh. Tot. = 765 mm → Cave 28 Cave 37	32726K* 3272CH* 3272J0* 3272J3*	32735S 3273CK 3273Q5 3273Q8	← Lungh. Tot. = 1065mm → Cave 37 Cave 28	
LATO SX FI 00127 - FI 00127/A*	10-14 q.li	A = ABS 54 10-14 q.li	FI 00128 - FI 00128/A*	LATO DX



NOTE ABS 54D su richiesta

Jumper	2.0 80Kw 2.5 D 63Kw	94>01 2.5 TD 79Kw 94>01 2.8 HDI 94Kw	94>01 2.2 HDI 74Kw 2002>	2002>
	RIFERIMENTI ORIGINALI			
← Lungh. Tot. = 755 mm → Cave 28 Cave 41	32727K* 3273CK* 3272CL* 3272J1* 3272J5*	3273CK* 3273Q6* 3273R0* 3273ST*	← Lungh. Tot. = 1075 mm → Cave 41 Cave 28	
LATO SX FI 00129 - FI 00129/A*	10-14 q.li	A = ABS 54 10-14 q.li	FI 00130 - FI 00130/A*	LATO DX

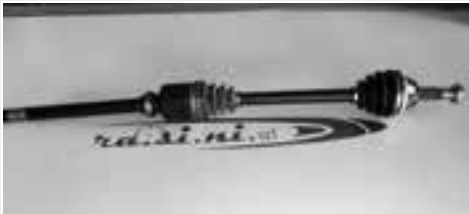
NOTE ABS 54D su richiesta

Jumper	2.0 80Kw 2.5 D 63Kw	94>01 2.5 TD 76Kw 94>01 2.8 HDI 94Kw	94>01 2002>	
	RIFERIMENTI ORIGINALI			
← Lungh. Tot. = 760 mm → Cave 35 Cave 41			← Lungh. Tot. = 1084 mm → Cave 41 Cave 35	
LATO SX FI 00131 - FI 00131/A	18 q.li	18 q.li	FI 00132 - FI 00132/A	LATO DX

NOTE ABS 54D su richiesta

Jumpy	1.6 58Kw 1.9 D 51Kw	1994> 1994>		
	RIFERIMENTI ORIGINALI			
← Lungh. Tot. = 645 mm → Cave 27 Cave 24	3272L1* 3272L9 3272M0 3272P5* 9699475588	32735X* 3273T3 3273T4 3273V7 3273W0*	← Lungh. Tot. = 929 mm → Cave 24 Cave 27	
LATO SX FI 00120 - FI 00120/A	Fusello L/C 62mm	A = ABS 48	FI 00121 - FI 00121/A	LATO DX

NOTE ABS 48D su richiesta

Jumpy

1.9 TD 47Kw

1996>



← Lungh. Tot. = 641 mm →
Cave 27 Cave 37

LATO SX **FI 00122 - FI 00122/A**

RIFERIMENTI ORIGINALI

32722L*
32723L*
3272K8
3272L0
3272V0*
3272V7*
9617408188

Fusello L/C 62mm

327306*
327307E*
327315*
3273S2
3273S2*
3273S4
9617408288

A = ABS 48



← Lungh. Tot. = 929 mm →
Cave 37 Cave 27

FI 00123 - FI 00123/A LATO DX

NOTE

Jumpy

1.6 HDI 66Kw

2007>



← Lungh. Tot. = 668 mm →
Cave 28 Cave 24

LATO SX **FI 01026**

RIFERIMENTI ORIGINALI



← Lungh. Tot. = 955 mm →
Cave 24 Cave 28

FI 01027 LATO DX

NOTE

Jumpy

2.0 HDI 88/94/100Kw
2.0 I 103Kw2007>
2007>

← Lungh. Tot. = 652 mm →
Cave 28 Cave 37

LATO SX **FI 01020**

RIFERIMENTI ORIGINALI

3272NP
1497187088

1497188088
3272NQ



← Lungh. Tot. = 985 mm →
Cave 37 Cave 28

FI 01021 LATO DX

NOTE

LN - LNA

LN 24Kw
LNA 24Kw78>86
78>86

← Lungh. Tot. = 420 mm →
Cave 21 Cave 12

LATO SX **CI 00181**

RIFERIMENTI ORIGINALI



5508423





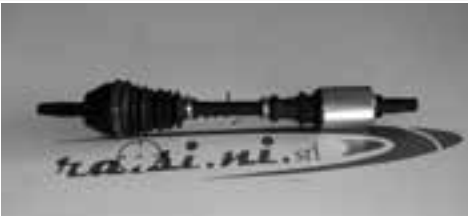

← Lungh. Tot. = 420 mm →
Cave 12 Cave 21



CI 00181 LATO DX



NOTE

Nemo 1.3 HDI 50Kw		2008>	
 <p>← Lungh. Tot. = 610 mm → Cave 25 Cave 24</p> <p>LATO SX PE 01054</p>	RIFERIMENTI ORIGINALI 21023916 55702107 51808105		 <p>← Lungh. Tot. = 920 mm → Cave 24 Cave 25</p> <p>PE 01055 LATO DX</p>
		46308366 46308521 Fusello L/C 290mm	
NOTE			

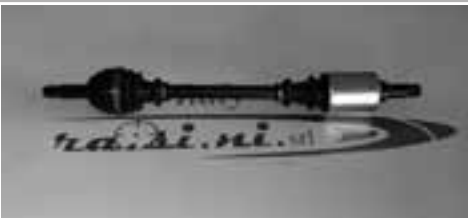

Nemo 1.3 HDI 50Kw		2008>	
 <p>← Lungh. Tot. = 610 mm → Cave 25 Cave 24</p> <p>LATO SX FI 01114</p>	RIFERIMENTI ORIGINALI 1607440280		 <p>← Lungh. Tot. = 920 mm → Cave 24 Cave 25</p> <p>FI 01115 LATO DX</p>
		1607440180 Fusello L/C 390mm	
NOTE			

Nemo 1.4 54Kw		02/2008>	
 <p>← Lungh. Tot. = 650 mm → Cave 22 Cave 22</p> <p>LATO SX PE 01150</p>	RIFERIMENTI ORIGINALI 51783853 3272SJ 3272SK		 <p>← Lungh. Tot. = 882 mm → Cave 22 Cave 22</p> <p>PE 01151 LATO DX</p>
		51783825 3273SZ 3273TA L/C.58	
NOTE Fonico Ø 51			



Nemo 1.4 HDI 50Kw		2008>	
 <p>← Lungh. Tot. = 660 mm → Cave 25 Cave 22</p> <p>LATO SX PE 01052</p>	RIFERIMENTI ORIGINALI 3272SL 3272SN 51783854		 <p>← Lungh. Tot. = 890 mm → Cave 22 Cave 25</p> <p>PE 01053 LATO DX</p>
		3273TC 51783852 Fusello L/C 58mm	
NOTE Fonico Ø 51			

Saxo	1.0 33/37Kw 1.1 40/44Kw	1999> 1.4 55Kw 1999> 1.5 D 42/43Kw	1999> 1999>
	RIFERIMENTI ORIGINALI		
← Lungh. Tot. = 624 mm → Cave 21 Cave 22	32722Q* 32723Q* 32729P A = ABS 48	32737F 32737H* 32737J* 3273H A = ABS 48	← Lungh. Tot. = 806 mm → Cave 22 Cave 21
LATO SX CI 00169 - CI 00169/A*			CI 00170 - CI 00170/A* LATO DX



NOTE

Saxo	1.0 33/37 kw 1.1 40/44 kw	1996> 1996>	
	RIFERIMENTI ORIGINALI		
← Lungh. Tot. = 617 mm → Cave 21 Cave 22	3272W5 32723J A = ABS 48	32735C 327356 A = ABS 48	← Lungh. Tot. = 800 mm → Cave 22 Cave 21
LATO SX CI 00101			CI 00102 LATO DX



NOTE Cerchio 3 bulloni



Saxo	1.0 33/37Kw 1.1 40/44Kw	96>99 1.4 55Kw 96>99 1.5 D 42/43Kw	96>99 96>99
	RIFERIMENTI ORIGINALI		
← Lungh. Tot. = 614 mm → Cave 21 Cave 22	32721K 95666908 95666940 327255* 9566694077* A = ABS 48D	32730K 32735K 95666941 9566694187* 327E3* A = ABS 48D	← Lungh. Tot. = 798 mm → Cave 22 Cave 21
LATO SX PE 00103 - PE 00103/A			PE 00104 - PE 00104/A LATO DX

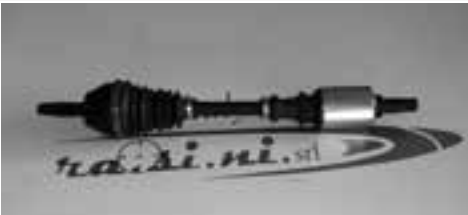

NOTE Cerchio 4 bulloni



Saxo	1.6 16v VTL-VTS 87Kw 1.6 I 65/66Kw	96>99 96>99	
	RIFERIMENTI ORIGINALI		
← Lungh. Tot. = 610 mm → Cave 21 Cave 22	3272G1* 3272X9* Fusello L/C 58mm	3273N7* 32790L* A = ABS 48 Fusello L/C 240mm	← Lungh. Tot. = 801 mm → Cave 22 Cave 21
LATO SX PE 00105 - PE 00105/A*			PE 00106 - PE 00106/A* LATO DX

NOTE ABS 48D su richiesta

Saxo		1.6 16v VTL-VTS 87Kw 1.6 l 65/66Kw	1999> 1999>	
 <p>← Lungh. Tot. = 620 mm → Cave 21 Cave 22</p> <p>LATO SX CI 00193 - CI 00193/A*</p>	RIFERIMENTI ORIGINALI		 <p>← Lungh. Tot. = 810 mm → Cave 22 Cave 21</p> <p>CI 00194 - CI 00194/A* LATO DX</p>	
	32724Q 32725Q 32728Q* 32729Q*	32737K 32737L 32737Q* 32737R*		Fusello L/C 58mm
NOTE ABS 48D su richiesta				

Visa		Club Club Special	78>89 78>89	
 <p>← Lungh. Tot. = 585 mm → Cave 21 Ø 115</p> <p>LATO SX CI 00195</p>	RIFERIMENTI ORIGINALI		 <p>← Lungh. Tot. = 585 mm → Ø 115 Cave 21</p> <p>CI 00195 LATO DX</p>	
	5480643			
NOTE				

Visa		1.0 34Kw 1.1 37Kw	78>89 78>89	1.4 44Kw	78>89
 <p>← Lungh. Tot. = 685 mm → Cave 21 Cave 22</p> <p>LATO SX CI 00196</p>	RIFERIMENTI ORIGINALI		 <p>← Lungh. Tot. = 685 mm → Cave 22 Cave 21</p> <p>CI 00196 LATO DX</p>		
	95582409 95603330 327459				
NOTE					

Visa		1.7 D 43/44Kw 1.6 GTI 76Kw	84>89 84>89	
 <p>← Lungh. Tot. = 564 mm → Cave 21 Cave 24</p> <p>LATO SX CI 00141</p>	RIFERIMENTI ORIGINALI		 <p>← Lungh. Tot. = 840 mm → Cave 24 Cave 21</p> <p>CI 00142 LATO DX</p>	
	327366 95591073 95619481	3273L9 95591074 95619482		
NOTE				

Xantia

1.6 | 65Kw
1.8 I, 1.8 16v 66/74/81Kw93>98 | 1.9 D, 1.9 SD 50/51/55Kw
93>03

94>98

← Lungh. Tot. = 620 mm →
Cave 25 Cave 24

LATO SX

CI 00143 - /A - /B*

RIFERIMENTI ORIGINALI

3272G5
3272G8*
3272G9*
3272Q0*
3272Q9*
96141635*
96141637*A = ABS 48D Ø90
B = ABS 48D Ø993273P3*
3273W8*
3273W9*
3273X3*
96164213*
96164350A = ABS 48D Ø90
B = ABS 48D Ø99← Lungh. Tot. = 895 mm →
Cave 24 Cave 25

CI 00144 - /A - /B*

LATO DX

NOTE ABS 48D

Xantia

1.9 TD 66Kw
2.0 16v 110/112Kw94>98 | 2.0 I, 2.0 16v
93>98 | 110/112Kw - 89/97Kw93>98 | 1.9 SD 55Kw
2.0 HDI 66Kw85>03
98>03← Lungh. Tot. = 610 mm →
Cave 25 Cave 24

LATO SX

CI 00145 - /A* - /B*

RIFERIMENTI ORIGINALI

3272G7
3272G9*
3272Q5*
3272Q6*
96141637*

Fusello L/C 62mm

3273P3*
3273W8*
3273W9*
3273X3*
96164213*A = ABS 48 Ø90
B = ABS 48 Ø99← Lungh. Tot. = 895 mm →
Cave 24 Cave 25

CI 00144 - /A* - /B*

LATO DX

NOTE ABS 48D

Xantia

2.0 T 108Kw
2.0 HDI 80Kw95>03 | 2.1 TD 80Kw
98>03 | 3.0 24v 140Kw95>98
97>03← Lungh. Tot. = 615 mm →
Cave 25 Cave 37

LATO SX

CI 00147

RIFERIMENTI ORIGINALI

3272TS

Fusello 68,5mm

3273Z7
3273Z8

Fusello 361mm

← Lungh. Tot. = 925 mm →
Cave 37 Cave 25

CI 00148

LATO DX

NOTE ABS 48D Ø99

XM

2.1 TD 60Kw
2.1 TD Aut. 60Kw89>94 | 3.0 V6, V6 24v
89>94 | 123/125, 147Kw89>94 | 3.0 V6 Aut. 123/125Kw
3.0 V6 24v Aut. 147Kw89>94
89>94← Lungh. Tot. = 646 mm →
Cave 28 Cave 37

LATO SX

CI 00151 - /A+ - /B*



RIFERIMENTI ORIGINALI

327235*
327260*
327287*
95644260Fusello L/C Ø102
Fusello 69mm327360*
95643952
96145819*A = ABS 48
B = ABS 29
Fusello L/C Ø102
Fusello 365mm← Lungh. Tot. = 936 mm →
Cave 37 Cave 28



CI 00152 - /A+ - /B*

LATO DX



NOTE

XM	2.0 I 16v 97Kw 2.0 I 16v Aut 97Kw	1994> 1994>	2.0 Turbo 108Kw 2.0 Turbo Aut. 108Kw	1994> 1994>	2.1 TD 80Kw 2.1 YD Aut. 80Kw	1994> 1994>
 <p>← Lungh. Tot. = 646 mm → Cave 28 Cave 37</p>		<p>RIFERIMENTI ORIGINALI</p> <p>327260* 3272J9*</p> <p>A = ABS 48 B = ABS 29 Fusello L/C Ø90 Fusello 69mm</p>		 <p>← Lungh. Tot. = 955 mm → Cave 37 Cave 28</p>		
<p>LATO SX CI 00153 - /A* - /B*</p>				<p>CI 00154 - /A* - /B* LATO DX</p>		



NOTE ABS 48D/29D su richiesta

XM	2.5 TD 95Kw 3.0 V6 147Kw	1994> 1994>				
 <p>← Lungh. Tot. = 641 mm → Cave 28 Cave 41</p>		<p>RIFERIMENTI ORIGINALI</p> <p>327260*</p> <p>Fusello L/C 70mm</p>		 <p>← Lungh. Tot. = 955 mm → Cave 41 Cave 28</p>		
<p>LATO SX CI 00177/A - /B*</p>				<p>CI 00178/A* - /B* LATO DX</p>		

NOTE ABS 48D/29D su richiesta

XM	2.0 79/84Kw 2.1 D 12 SX 60Kw	>1994 >1994				
 <p>← Lungh. Tot. = 654 mm → Cave 28 Cave 24</p>		<p>RIFERIMENTI ORIGINALI</p> <p>327238 327241* 327253* 3272A3*</p>		 <p>← Lungh. Tot. = 940 mm → Cave 24 Cave 28</p>		
<p>LATO SX CI 00149 - /A - /B</p>				<p>CI 00150 - /A - /B LATO DX</p>		

NOTE

Xsara	1.4 55Kw	1997>				
 <p>← Lungh. Tot. = 592 mm → Cave 21 Cave 22</p>		<p>RIFERIMENTI ORIGINALI</p> <p>32722Z</p> <p>Fusello L/C 58mm</p>		 <p>← Lungh. Tot. = 868 mm → Cave 22 Cave 21</p>		
<p>LATO SX CI 00155 - CI 00155/A</p>				<p>CI 00156 - CI 00156/A LATO DX</p>		

NOTE ABS 29D su richiesta

Xsara

1.6 55/65/70/74/80Kw

2000>



← Lungh. Tot. = 594 mm →
Cave 25 Cave 22

LATO SX

CI 00105 - CI 00105/A

RIFERIMENTI ORIGINALI

32725L
3272Y6
3272Y7
3272Z2*

Fusello 58mm

32730W
32730X
32734T*
32736G*

Fusello L/C 317mm
A = ABS 29



← Lungh. Tot. = 860 mm →
Cave 22 Cave 25

CI 00106 - CI 00106/A

LATO DX

NOTE ABS 29D su richiesta

Xsara

1.8 85Kw
1.9 D 44Kw1997> 1.8 I Aut. 74Kw
1997> 1.9 D 50/51Kw1997> 1.9 SD 55Kw
1997>

1997>



← Lungh. Tot. = 594 mm →
Cave 25 Cave 24

LATO SX

CI 01009 - CI 01009/A*

RIFERIMENTI ORIGINALI

32721N*
3272A9
3272Y4*
3273K2*
96167303
96171856

32730S*
3273K4
96167304
96171875*

A = ABS 29



← Lungh. Tot. = 865 mm →
Cave 24 Cave 25

CI 01019 - CI 01019/A*

LATO DX

NOTE

Xsara-Xsara Picasso

1.9 TD 66Kw
2.0 HDI 66Kw1997> 2.0 I 16v 97/120Kw
1997> 2.0 HDI 66Kw (Picasso)1997>
1999>

← Lungh. Tot. = 585 mm →
Cave 25 Cave 24

LATO SX

CI 00167 - CI 00167/A*

RIFERIMENTI ORIGINALI

3272FP*
96171871*

Fusello L/C 62mm

32730S*
96171875*

A = ABS 29



← Lungh. Tot. = 865 mm →
Cave 24 Cave 25

CI 00168 - CI 00168/A*

LATO DX

NOTE

Xsara Picasso

1.6 HDI 80Kw

2004>



← Lungh. Tot. = 586 mm →
Cave 25 Cave 24

LATO SX

CI 01011

RIFERIMENTI ORIGINALI

Fusello L/C 62mm

ABS 48



← Lungh. Tot. = 875 mm →
Cave 24 Cave 25

CI 01012

LATO DX



NOTE



ZX	1.1 40/44Kw 1.4 l 55Kw	91>97 91>97	RIFERIMENTI ORIGINALI	
	327218 3272R7 3272R8 95669013 96072988	32732Y 32735K 327387 3273Y2 96072989		
← Lungh. Tot. = 596 mm → Cave 21 Cave 22			← Lungh. Tot. = 860 mm → Cave 22 Cave 21	
LATO SX	CI 00161		CI 00162	LATO DX
NOTE ABS 48				



ZX	1.1 40/44Kw 1.4 l 55Kw	91>97 91>97	RIFERIMENTI ORIGINALI	
	32721F 32725W 32728L 32726F	32733Z		
← Lungh. Tot. = 614 mm → Cave 25 Cave 22			← Lungh. Tot. = 870 mm → Cave 22 Cave 25	
LATO SX	CI 01020		CI 01021	LATO DX
NOTE ABS 29D				



ZX	1.6 l, 1.6 Aut. 65Kw 2.0 l, 2.0 Aut. 89/90Kw	1991> 1991>	1.8 D, 1.8 Aut., 1.8 l, 1.8 16v 43/44/74/81Kw	1991> 1991>	1.9 D, 1.9 Aut., 1.9 l 47/51Kw, 88Kw	1991>
	3272A9 3272Y4* 96167303 96171856 96171874* 9642426680*	32730S* 3273K4 96167304 96171875* 9642426780*		A = ABS 29 B = ABS 48 Ø90		
← Lungh. Tot. = 595 mm → Cave 25 Cave 24			← Lungh. Tot. = 866 mm → Cave 24 Cave 25			
LATO SX	CI 00163 - /A* - /B*		CI 00164 - /A* - /B*	LATO DX		
NOTE						



ZX	1.9 TD 2.0 l 16v	1992> 1992>	RIFERIMENTI ORIGINALI	
	3272FP 96171871*	32730S* 32731K 3273K4 96171875*		
← Lungh. Tot. = 585 mm → Cave 25 Cave 24	Fusello L/C 62mm	A = ABS 29 B = ABS 48	← Lungh. Tot. = 865 mm → Cave 24 Cave 25	
LATO SX	CI 00167 - /A* - /B		CI 00168 - /A* - /B	LATO DX
NOTE ABS 29D su richiesta				

Duster		1.5 DCi 66/77Kw	2010>		
 <p>← Lungh. Tot. = 702 mm → Cave 25 Cave 26</p> <p>LATO SX DC 00109</p>	RIFERIMENTI ORIGINALI		 <p>← Lungh. Tot. = 950 mm → Cave 26 Cave 25</p> <p>DC 00110 LATO DX</p>	391015061R	391008165R
				Fusello L/C 325mm	
NOTE					

Logan		1.4 55Kw 1.6 64Kw	2004> 2004>		
 <p>← Lungh. Tot. = 682 mm → Cave 21 Rullo Ø 30</p> <p>LATO SX DC 00101</p>	RIFERIMENTI ORIGINALI		 <p>← Lungh. Tot. = 761 mm → Int. 23 Cave 21</p> <p>DC 00102 LATO DX</p>	8200444438	8200484373
NOTE Fonico Ø 49					

Logan		1.5 48/50Kw			
 <p>← Lungh. Tot. = 682 mm → Cave 23 Rullo Ø 30</p> <p>LATO SX DC 00103</p>	RIFERIMENTI ORIGINALI		 <p>← Lungh. Tot. = 765 mm → Cave Int. 23 Cave 23</p> <p>DC 00104 LATO DX</p>	6001548659 8200503358	6001548661 8200503359
NOTE Fonico Ø 49					

Logan		Pick-Up 1.6, 1.5 DCi	2008>	Express 1.6, 1.5 DCi 64/63/50Kw	2009>	MCV 1.5 DCi 63/65Kw	2010>
 <p>← Lungh. Tot. = 662 mm → Cave 23 Cave 26</p> <p>LATO SX DC 00111</p>	RIFERIMENTI ORIGINALI		 <p>← Lungh. Tot. = 890 mm → Cave 26 Cave 23</p> <p>DC 00112 LATO DX</p>	600155095 600155096 600155690 600155691	600155093 600155094 600155692 600155693		
NOTE Fonico Ø 49							



Sandero 1.2 16v 55kw-1.4 55kw 06/2008> 1.5 dci 50kw		
 <p>← →</p>	RIFERIMENTI ORIGINALI	
	6001547028 6001548102	6001548103 6001547029
<p>LATO SX</p> <p>DC 00105</p>		 <p>← →</p> <p>Int. 23 Lung. Tot. = 763 mm Cave 21</p> <p>DC 00106 LATO DX</p>
NOTE		

Sandero 1.5 DCi		
<p>← →</p>	RIFERIMENTI ORIGINALI	
<p>LATO SX</p> <p>DC 00111</p>		<p>DC 00112 LATO DX</p>
NOTE		

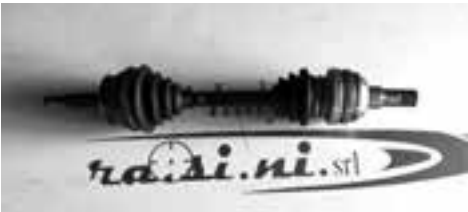

<p>← →</p>	RIFERIMENTI ORIGINALI	
<p>LATO SX</p>		<p>LATO DX</p>
NOTE		

<p>← →</p>	RIFERIMENTI ORIGINALI	
<p>LATO SX</p>		<p>LATO DX</p>
NOTE		

Aveo	1.2 51/63Kw	2011		
		RIFERIMENTI ORIGINALI		
		96852740	95015622	
← Lungh. Tot. = 603 mm → Cave 25 Cave 22		← →		
LATO SX	DA 00139		DA 00140	LATO DX
NOTE Fonico Ø 51				

Aveo	1.2 55/66Kw 1.2 LPG 62Kw	2008> 2008>		
		RIFERIMENTI ORIGINALI		
		96832203	96832204	
← Lungh. Tot. = 660 mm → Cave 22 Cave 22		← Lungh. Tot. = 875 mm → Cave 22 Cave 22		
LATO SX	DA 00137		DA 00138	LATO DX
NOTE ABS 47				

Captiva	2.0 D 4WD 93Kw C/A 2.4 123Kw C/A	2006>2012 2011>		
		RIFERIMENTI ORIGINALI		
← Lungh. Tot. = 619 mm → Cave 30 Cave 27		← Lungh. Tot. = 540 mm → Cave 27 Cave 30		
LATO SX	DA 00141		DA 00142	LATO DX
NOTE				

Espero	1.5 I 16v 66Kw	95>99		
		RIFERIMENTI ORIGINALI		
			A = ABS 47	
← Lungh. Tot. = 597 mm → Cave 33 Cave 34		← Lungh. Tot. = 932 mm → Cave 34 Cave 33		
LATO SX	DA 00111 - DA 00111/A		DA 00112 - DA 00112/A	LATO DX
NOTE ABS 47D su richiesta				

Kalos	1.4 61/69Kw	02>04	
 ← Lungh. Tot. = 563 mm → Cave 22 Cave 22	RIFERIMENTI ORIGINALI		 ← Lungh. Tot. = 882 mm → Cave 22 Cave 22
	96485019	96485020	
LATO SX	DA 00117		DA 00118 LATO DX
NOTE ABS 47D			

Kalos Chevrolet	1.2 53Kw	2005>	
 ← Lungh. Tot. = 668 mm → Cave 22 Cave 22	RIFERIMENTI ORIGINALI		 ← Lungh. Tot. = 882 mm → Cave 22 Cave 22
LATO SX	DA 00121		DA 00122 LATO DX
NOTE ABS 47D			

Lanos	1.4 55Kw 1.5 66Kw	1997> 1997>	
 ← Lungh. Tot. = 575 mm → Cave 22 Cave 34	RIFERIMENTI ORIGINALI		 ← Lungh. Tot. = 910 mm → Cave 34 Cave 22
		A = ABS 47	
LATO SX	DA 00103 - DA 00103/A		DA 00104 - DA 00104/A LATO DX
NOTE			

Lanos	1.6 16v 78Kw	1997>	
 ← Lungh. Tot. = 592 mm → Cave 33 Cave 34	RIFERIMENTI ORIGINALI		 ← Lungh. Tot. = 910 mm → Cave 34 Cave 33
LATO SX	DA 00115 - DA 00115/A		DA 00116 - DA 00116/A LATO DX
NOTE A = ABS 47D			

Matiz Chevrolet

800 38Kw daewoo
800 38kw chevrolet1998>
2005>← Lungh. Tot. = 613 mm →
Cave 23 Cave 22LATO SX **DA 00101 - DA 00101/A***

RIFERIMENTI ORIGINALI

96257821
96257823*96257822
96257824*

A = ABS 40

← Lungh. Tot. = 783 mm →
Cave 22 Cave 23**DA 00102 - DA 00102/A*** LATO DX

NOTE

Matiz Chevrolet

1.0 47/49 Kw chevrolet
1.0 47 Kw daewoo2005>
1998>← Lungh. Tot. = 554 mm →
Cave 23 Cave 22LATO SX **DA 00105**

RIFERIMENTI ORIGINALI

96287813

96287814

ABS 40

← Lungh. Tot. = 832 mm →
Cave 22 Cave 23**DA 00106** LATO DX

NOTE

Nexia

1.5 52/55Kw
1.5 44Kw95>97 | 1.5 16v 66Kw
96>97

95>97

← Lungh. Tot. = 575 mm →
Cave 22 Cave 34LATO SX **DA 00113 - DA 00113/A**

RIFERIMENTI ORIGINALI

A = ABS 47

← Lungh. Tot. = 910 mm →
Cave 34 Cave 22**DA 00114 - DA 00114/A** LATO DX

NOTE

Nubira

1.6 16v 78Kw

1997>

← Lungh. Tot. = 594 mm →
Cave 33 Cave 34LATO SX **DA 00107**

RIFERIMENTI ORIGINALI

← Lungh. Tot. = 952 mm →
Cave 34 Cave 33**DA 00108** LATO DX

NOTE ABS 47

Trax		1.7 CTDI 96Kw	2012>	
		RIFERIMENTI ORIGINALI		
		5374160 94560844	5374156 94560848	
←				→
			Lungh. Tot. = 590mm	
			34	25
LATO SX	DA 00140		DA 00144	LATO DX

NOTE

		RIFERIMENTI ORIGINALI		
←				→
LATO SX				LATO DX



NOTE



		RIFERIMENTI ORIGINALI		
←				→
LATO SX				LATO DX



NOTE

		RIFERIMENTI ORIGINALI		
←				→
LATO SX				LATO DX



NOTE

Cuore		800	1990>		
 <p>← Lungh. Tot. = → Cave 24</p>	RIFERIMENTI ORIGINALI		 <p>← Lungh. Tot. = → Cave 24</p>	LATO SX	LATO DX
	DH 00101				
NOTE					

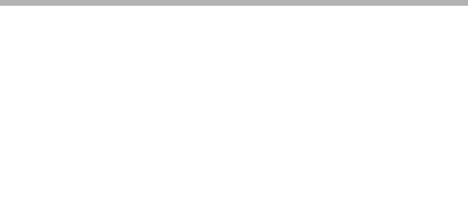
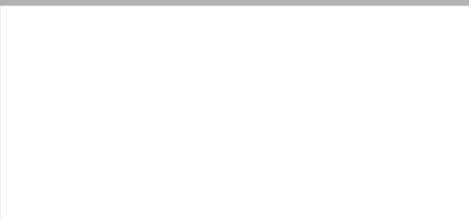

Terios		1.3 4WD 61/63Kw	1997>		
 <p>← Lungh. Tot. = 540 mm → Cave 24 Cave 23</p>	RIFERIMENTI ORIGINALI		 <p>← Lungh. Tot. = 850 mm → Cave 23 Cave 24</p>	LATO SX	LATO DX
	DH 00103 - DH 00103/A				
NOTE					

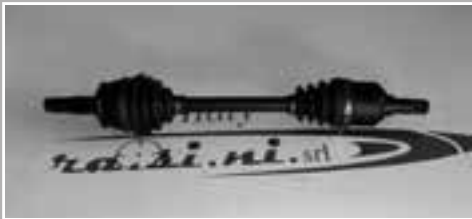
 <p>← →</p>	RIFERIMENTI ORIGINALI		 <p>← →</p>	LATO SX	LATO DX
NOTE					



 <p>← →</p>	RIFERIMENTI ORIGINALI		 <p>← →</p>	LATO SX	LATO DX
NOTE					

500	1.1 40Kw	1994>1998		
 <p>← Lungh. Tot. = 555 mm → Cave 22 Cave 22</p> <p>LATO SX FI 00101</p>	RIFERIMENTI ORIGINALI		 <p>← Lungh. Tot. = 775 mm → Cave 22 Cave 22</p> <p>FI 00102 LATO DX</p>	
	46476612	46409864		

NOTE

500	900 29/30Kw	1991>1998		
 <p>← Lungh. Tot. = 535 mm → Cave 22 Rullo Ø 29</p> <p>LATO SX FI 00162</p>	RIFERIMENTI ORIGINALI		 <p>← Lungh. Tot. = 795 mm → Rullo Ø 29 Cave 22</p> <p>FI 00163 LATO DX</p>	
	7668798 46477176	7699037 46476614		

NOTE

500	0.9 Turbo 4V 63Kw 0.9 Twinair 77Kw	2010> 2013>	1.2 natural power 1.3 MJet 55Kw	2008> 2007>	1.4 74Kw	2007>
 <p>← Lungh. Tot. = 617 mm → Cave 25 Cave 22</p> <p>LATO SX FI 01033</p>	RIFERIMENTI ORIGINALI		 <p>← Lungh. Tot. = 850 mm → Cave 22 Cave 25</p> <p>FI 01034 LATO DX</p>			
	51787864 51955482	51839644 51787862 51955477				

NOTE Fonico Ø 51

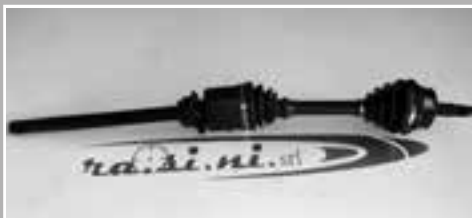
500	1.3 MJT 70Kw	2009>		
 <p>← Lungh. Tot. = 570 mm → Cave 25 Cave 24</p> <p>LATO SX FI 01124</p>	RIFERIMENTI ORIGINALI		 <p>← Lungh. Tot. = 880 mm → Cave 24 Cave 25</p> <p>FI 01125 LATO DX</p>	
	51839650	51854039		Fusello L/C 360mm

NOTE Fonico Ø 51

500

1.2 51Kw

2007>



← Lungh. Tot. = 625 mm →
Cave 22 Cave 22

LATO SX

FI 01035

RIFERIMENTI ORIGINALI

51902278

51839645



← Lungh. Tot. = 850 mm →
Cave 22 Cave 22

FI 01036

LATO DX

NOTE Fonico Ø 51

500 Abarth

1.4 Turbo 103/118Kw

08/2008>



← Lungh. Tot. = 580 mm →
Cave 25 Cave 24

LATO SX

FI 01110

RIFERIMENTI ORIGINALI

51820349

Fusello L/C 390

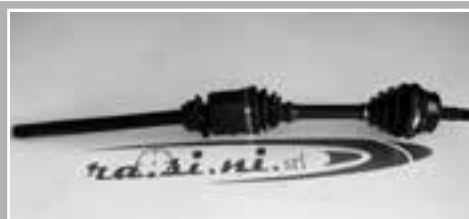

← Lungh. Tot. = 890 mm →
Cave 24 Cave 25

FI 01111

LATO DX

NOTE Fonico Ø 51

500 C

1.2 51Kw

2009>



← Lungh. Tot. = 615 mm →
Cave 22 Cave 22

LATO SX

FI 00194

RIFERIMENTI ORIGINALI

51787863

51787861



← Lungh. Tot. = 868 mm →
Cave 22 Cave 22

FI 00195

LATO DX

NOTE Fonico Ø 47

500 L

0.9 77Kw

09/2012>



← Lungh. Tot. = 665 mm →
Cave 25 Cave 22

LATO SX

FI 01122

RIFERIMENTI ORIGINALI

3301055000



← Lungh. Tot. = 902 mm →
Cave 22 Cave 25



FI 01123

LATO DX

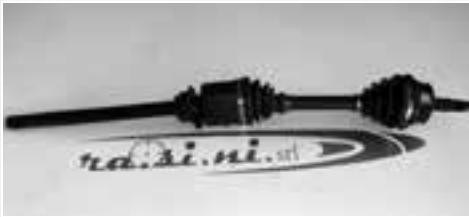
NOTE Fonico Ø 51 - Para P. Ø 73

500 L		1.3 MJT 62Kw	09/2012>	
 <p>Lungh. Tot. = 640 mm Cave 25 Cave 24</p>	RIFERIMENTI ORIGINALI		 <p>Lungh. Tot. = 920 mm Cave 24 Cave 25</p>	
		3300055000		Fuello L/C 378mm
LATO SX	FI 01120			LATO DX

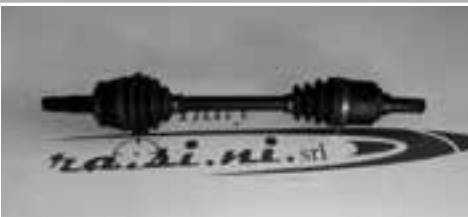
NOTE Fonico Ø 51

500 L		1.4 70/88Kw 1.4 L PG 88Kw	2013> 2014>	
 <p>Lungh. Tot. = 660 mm Cave 25 Cave 22</p>	RIFERIMENTI ORIGINALI		 <p>Lungh. Tot. = 660 mm Cave 22 Cave 25</p>	
		51929168		51929167 51948165
LATO SX	FI 01106			LATO DX

NOTE

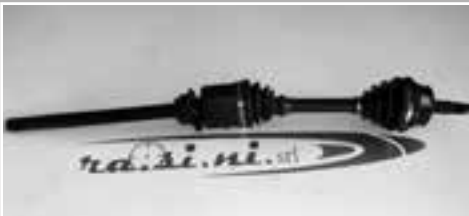
500 L		1.6 JTD 77/88Kw	2013>	
 <p>Lungh. Tot. = 600 mm Cave 25 Cave 25</p>	RIFERIMENTI ORIGINALI		 <p>Lungh. Tot. = 600 mm Cave 25 Cave 25</p>	
		51885867		55233322
LATO SX	FI 01108			LATO DX

NOTE Fonico Ø 51

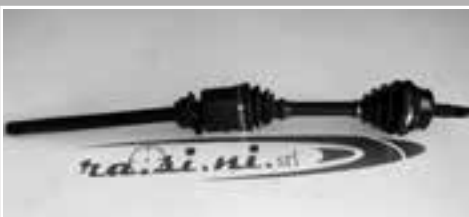
500 L		1.6 M Jet 88Kw	2014	
 <p>Lungh. Tot. = 600 mm Cave 27 Cave 24</p>	RIFERIMENTI ORIGINALI		 <p>Lungh. Tot. = 600 mm Cave 24 Cave 27</p>	
		51910229		
LATO SX	FI 01039			LATO DX

NOTE

500 L

0.9 Natural Power 63Kw 2013>
0.9 Natural Power 77Kw 2012>

RIFERIMENTI ORIGINALI

51890142

51948166

← Lungh. Tot. = 688 mm →
Cave 25 Cave 22

LATO SX

FI 01080

← Lungh. Tot. = 876 mm →
Cave 22 Cave 25

FI 01081

LATO DX

NOTE

500 L

1.4

RIFERIMENTI ORIGINALI

51921278

51921279
55244488← Lungh. Tot. = 610 mm →
Cave 25 Cave 25

LATO SX

FI 01164

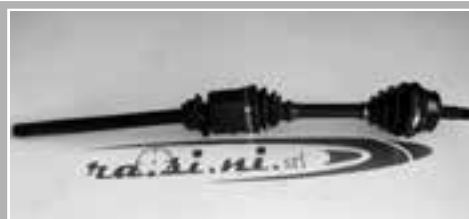
← Cave 25 →
Cave 25

FI 01165

LATO DX

NOTE Fonico Ø 51 - Parapolvere Ø 73

500 X

1.4 103Kw 2014 >
1.6 88Kw 2014 >

RIFERIMENTI ORIGINALI

51936052

← Lungh. Tot. = 633 mm →
Cave 27 Cave 26

LATO SX

FI 01162

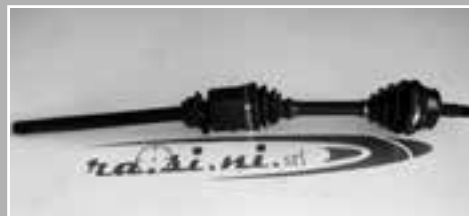

← →

FI 01163

LATO DX

NOTE Fonico Ø 59

500 X 4x4

1.4 103Kw
Posteriori

RIFERIMENTI ORIGINALI

51939962

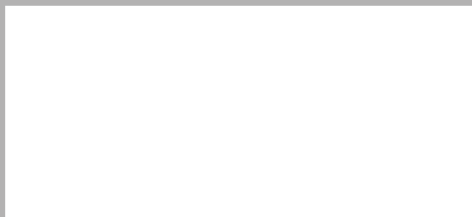
← Lungh. Tot. = 582 mm →
Cave 27 Cave int. 22

LATO SX

JP 00111

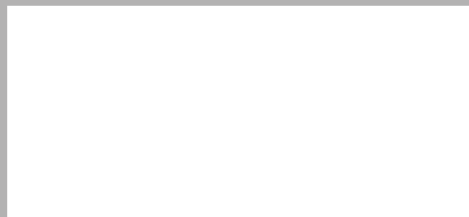
← Lungh. Tot. = 582 mm →
Cave int. 22 Cave 27



JP 00111

LATO DX

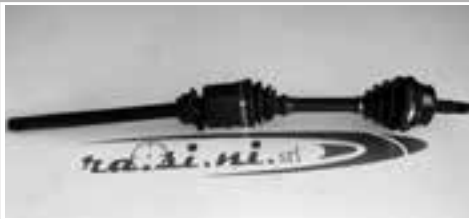
NOTE

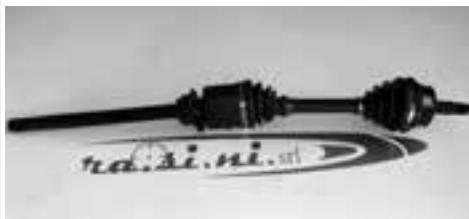
Bravo 1.9 MJT 85/110 Kw 04/2007>		
 <p>← Lungh. Tot. = 630 mm → Cave 25 Cave 25</p> <p>LATO SX FI 01061</p>	<p>RIFERIMENTI ORIGINALI</p> <p>46307887 46307857</p>	 <p>← Lungh. Tot. = 930 mm → Cave 25 Cave 25</p> <p>FI 01062 LATO DX</p>
	<p>46307857 46307865</p>	
NOTE Fonico Ø 59		

Bravo 1.4 T-jet 88/110 Kw 09/2007>		
 <p>← Lungh. Tot. = 630 mm → Cave 25 Cave 25</p> <p>LATO SX FI 01063</p>	<p>RIFERIMENTI ORIGINALI</p> <p>51794995 51861636</p>	 <p>← Lungh. Tot. = 930 mm → Cave 25 Cave 25</p> <p>FI 01064 LATO DX</p>
	<p>51861637 55209140</p> <p>Tot. 480mm Fusello L/C 365mm</p>	
NOTE Fonico Ø 51		

Bravo 1.4 66 Kw 04/2007>		
 <p>← Lungh. Tot. = 655 mm → Cave 25 Cave 22</p> <p>LATO SX FI 00192</p>	<p>RIFERIMENTI ORIGINALI</p> <p>46308116</p>	 <p>← Lungh. Tot. = 917 mm → Cave 22 Cave 25</p> <p>FI 00193 LATO DX</p>
	<p>46308115 46308112</p>	
NOTE Fonico Ø 51		

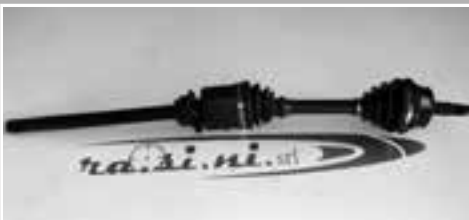
Bravo 1.6 MJT 77/88Kw 03/2008> 1.9 JTD 110Kw 2010>		
 <p>← Lungh. Tot. = 630 mm → Cave 25 Cave 25</p> <p>LATO SX FI 01010</p>	<p>RIFERIMENTI ORIGINALI</p> <p>46307857 51795511 51812053</p>	 <p>← Lungh. Tot. = 935 mm → Cave 25 Cave 25</p> <p>FI 01011 LATO DX</p>
	<p>46307857 51795511</p> <p>Fusello L/C 380mm</p>	
NOTE Fonico Ø 51		

Bravo

1.6 MJet 88Kw

2010>



← Lungh. Tot. = 610 mm →
Cave 25 Cave 25

LATO SX

LA 00150

RIFERIMENTI ORIGINALI

51868091
55213053

Paraolio Ø32

Paraolio Ø30
Fusello L/C 408mm

← Lungh. Tot. = 960 mm →
Cave 25 Cave 25

LA 00151

LATO DX

NOTE

Bravo

1.9 JTD 88Kw

2010>



← Lungh. Tot. = 630 mm →
Cave 25 Cave 25

LATO SX

FI 01140

RIFERIMENTI ORIGINALI

Fusello L/C 378mm



← Lungh. Tot. = 935 mm →
Cave 25 Cave 25

FI 01141

LATO DX

NOTE Fonico Ø 51 - Para P. Ø 73

Bravo - Brava

1.2 16v 59/60Kw
1.4 16v 55/59Kw98>01
98>00

← Lungh. Tot. = 600 mm →
Cave 22 Cave 22

LATO SX

FI 00106 - FI 00106/A

RIFERIMENTI ORIGINALI

7778448

7765363

A = ABS 44

A = ABS 44



← Lungh. Tot. = 915 mm →
Cave 22 Cave 22

FI 00107 - FI 00107/A

LATO DX

NOTE

Bravo - Brava

1.6 SX 66/76Kw

95>01



← Lungh. Tot. = 588 mm →
Cave 22 Rullo Ø 32

LATO SX

FI 00103 - FI 00103/A

RIFERIMENTI ORIGINALI

46307002

46307004

A = ABS 44

A = ABS 44







← Lungh. Tot. = 921 mm →
Rullo Ø 32 Cave 22



FI 00104 - FI 00104/A



LATO DX



NOTE



Bravo - Brava 1.6 76Kw (Exc ver. SX) 99>01		RIFERIMENTI ORIGINALI	
			
← Lungh. Tot. = 588 mm → Cave 22 Rullo Ø 32			← Lungh. Tot. = 921 mm → Rullo Ø 32 Cave 22
LATO SX FI 01044			FI 01045 LATO DX
NOTE Fonico Ø 51			



Bravo - Brava 1.8 GT 83Kw 95>98		RIFERIMENTI ORIGINALI	
	7778166	7778166	
← Lungh. Tot. = 470 mm → Cave 25 Ø 100	A = ABS 44	A = ABS 44	← Lungh. Tot. = 470 mm → Ø 100 Cave 25
LATO SX FI 01046 - FI 01046/A			FI 01046 - FI 01046/A LATO DX
NOTE			



Bravo - Brava 1.8 GT 83Kw 98>01 1.9 JTD 77Kw 98>01		RIFERIMENTI ORIGINALI	
	71783059		
← Lungh. Tot. = 470 mm → Cave 25 Ø 100			← Lungh. Tot. = 470 mm → Ø 100 Cave 25
LATO SX FI 01047			FI 01047 LATO DX
NOTE Fonico Ø 51			



Bravo - Brava 1.9 D 48Kw 95>01		RIFERIMENTI ORIGINALI	
	7694584	7737396	
← Lungh. Tot. = 575 mm → Cave 22 Rullo Ø 32	A = ABS 44	A = ABS 44	← Lungh. Tot. = 935 mm → Rullo Ø 32 Cave 22
LATO SX FI 00148 - FI 00148/A			FI 00149 - FI 00149/A LATO DX
NOTE ABS 44D su richiesta			



Bravo - Brava		1.9 TD 55/74Kw	95>98		
 <p>← Lungh. Tot. = 450 mm Cave 25 Ø 72 Stellare →</p> <p>LATO SX FI 00105 - FI 00105/A</p>	RIFERIMENTI ORIGINALI		 <p>← Lungh. Tot. = 450 mm Ø 72 Stellare Cave 25 →</p> <p>FI 00105 - FI 00105/A LATO DX</p>	46307109 ABS 46307110	46307109 ABS 46307110
	A = ABS 44	A = ABS 44			
NOTE ABS 44D su richiesta					



Bravo - Brava		1.9 JTD 55/74Kw	98>01		
 <p>← Lungh. Tot. = 450 mm Cave 25 Ø 72 Stellare →</p> <p>LATO SX FI 00150</p>	RIFERIMENTI ORIGINALI		 <p>← Lungh. Tot. = 450 mm Ø 72 Stellare Cave 25 →</p> <p>FI 00150 LATO DX</p>	46307408	46307408
NOTE Fonico Ø 51					



Bravo - Brava		2.0 HGT 113Kw	96>01		
 <p>← Lungh. Tot. = 470 mm Cave 25 Ø 100 →</p> <p>LATO SX FI 01048 - FI 01048/A</p>	RIFERIMENTI ORIGINALI		 <p>← Lungh. Tot. = 470 mm Ø 100 Cave 25 →</p> <p>FI 01048 - FI 01048/A LATO DX</p>	46307323 46307361	46307323 46307361
	A = ABS 44	A = ABS 44			
NOTE					



Coupé		1.8 16v 96Kw 2.0 20v 108Kw	1996> 1996>	2.0 16v 102Kw	1996>
 <p>← Lungh. Tot. = 485 mm Cave 25 Ø 100 →</p> <p>LATO SX FI 00156</p>	RIFERIMENTI ORIGINALI		 <p>← Lungh. Tot. = 485 mm Ø 100 Cave 25 →</p> <p>FI 00156 LATO DX</p>	46307111 46307010	46307111 46307010
	A = ABS44D	A = ABS 44D			
NOTE ABS 44D					



Coupé		2.0 16v T 140/145Kw	1994>	
 <p>Lungh. Tot. = 520 mm Cave 25 Ø 100</p>	RIFERIMENTI ORIGINALI		 <p>Lungh. Tot. = 520 mm Ø 100 Cave 25</p>	
	LATO SX	FI 00157		LATO DX
NOTE ABS 44D				



Coupé		2.0 20v T 162Kw	1994>	
 <p>Lungh. Tot. = 500 mm Cave 25 Ø 108</p>	RIFERIMENTI ORIGINALI		 <p>Lungh. Tot. = 500 mm Ø 108 Cave 25</p>	
	LATO SX	FI 00158		LATO DX
NOTE ABS 44D				



Croma		1.6 61Kw 1.9 TD 66Kw	1985>	2.0 CHT-IE-Turbo 1985> 66/88/101/110/114Kw	1985>	2.5 TD 55/74/77Kw	1985>
 <p>Lungh. Tot. = 518 mm Cave 25 Ø 100</p>	RIFERIMENTI ORIGINALI		 <p>Lungh. Tot. = 518 mm Ø 100 Cave 25</p>				
	LATO SX	FI 00153 - FI 00153/A*		LATO DX	FI 00153 - FI 00153/A		
NOTE ABS 90D su richiesta							



Croma		1.9 TD 66/69Kw 2.0 CHT 66Kw	>1993	2.0 88/101Kw >1993 2.0 Turbo 110Kw	>1993	2.5 D-TD 55/85Kw >1993	>1993
 <p>Lungh. Tot. = 525 mm Cave 25 Ø 100</p>	RIFERIMENTI ORIGINALI		 <p>Lungh. Tot. = 525 mm Ø 100 Cave 25</p>				
	LATO SX	FI 00154 - /A - /B		LATO DX	FI 00154 - /A - /B		
NOTE ABS 44D/90D su richiesta							

Croma		1.9 TD 69Kw 2.0 101Kw	1993> 2.0 T 114Kw 1993> 2.5 TD 55Kw	1993> 2.5 V6 119Kw 1993>	1993>
 <p>← Lungh. Tot. = 523 mm → Cave 27 Ø 100</p> <p>LATO SX FI 00155 - FI 00155/A</p>		<p>RIFERIMENTI ORIGINALI</p> <p>A = ABS 44</p>		 <p>← Lungh. Tot. = 523 mm → Ø 100 Cave 27</p> <p>FI 00155 - FI 00155/A LATO DX</p>	
<p>NOTE ABS 44D su richiesta</p>					



Croma Nuova		1.9 MJT 88/110Kw	2005>		
 <p>← Lungh. Tot. = 600 mm → Cave 30 Cave 25</p> <p>LATO SX FI 00186</p>		<p>RIFERIMENTI ORIGINALI</p> <p>170926 170927 5173926047</p> <p>Fusello L/C 435mm</p>		 <p>← Lungh. Tot. = 970 mm → Cave 25 Cave 30</p> <p>FI 00187 LATO DX</p>	
<p>NOTE Fonico Ø 59</p>					

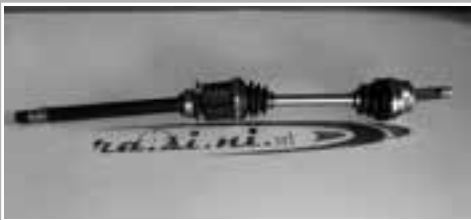

Croma Nuova		1.9 MJT C.A. 110Kw	2005>		
 <p>← Lungh. Tot. = 590 mm → Cave 30 Cave 27</p> <p>LATO SX FI 01022</p>		<p>RIFERIMENTI ORIGINALI</p> <p>Fusello L/C 450mm</p>		 <p>← Lungh. Tot. = 987 mm → Cave 27 Cave 30</p> <p>FI 01023 LATO DX</p>	
<p>NOTE Fonico Ø 59</p>					

Croma Nuova		2.4 Multijet C.A. 147Kw	2005>		
 <p>← Lungh. Tot. = 550 mm → Cave 30 Cave 27</p> <p>LATO SX FI 01024</p>		<p>RIFERIMENTI ORIGINALI</p> <p>46308082 51739264</p> <p>Fusello L/C 520mm</p>		 <p>← Lungh. Tot. = 1025 mm → Cave 27 Cave 30</p> <p>FI 01025 LATO DX</p>	
<p>NOTE Fonico Ø 59</p>					

Doblò		1.2 48Kw 1.9 D 46Kw	2001> 2001>	
 <p>← Lungh. Tot. = 615 mm → Cave 22 Rullo Ø 32</p>	RIFERIMENTI ORIGINALI		 <p>← Lungh. Tot. = 930 mm → Rullo Ø 32 Cave 22</p>	
	46307998	46308347		
LATO SX	FI 00160		FI 00161	LATO DX
NOTE Fonico Ø 51				

Doblò		1.3 MJet 16v 66Kw 1.6 MJet 66/77Kw	2009>2010 2010>	
 <p>← Lungh. Tot. = 605 mm → Cave 25 Cave 24</p>	RIFERIMENTI ORIGINALI		 <p>← Lungh. Tot. = 972 mm → Cave 24 Cave 25</p>	
	51810625	51810626		Paraolio Ø 30 Fusello L/C 460mm
LATO SX	FI 01132		FI 01133	LATO DX
NOTE Fonico Ø 51				

Doblò		1.6 16v 76Kw (metano)	2001>	
 <p>← Lungh. Tot. = 634 mm → Cave 22 Cave 22</p>	RIFERIMENTI ORIGINALI		 <p>← Lungh. Tot. = 920 mm → Cave 22 Cave 22</p>	
	46307796	46308346 46307797		
LATO SX	FI 01001		FI 01002	LATO DX
NOTE Fonico Ø 51				

Doblò		1.6 MJet 66/74/77Kw	2010>	
 <p>← Lungh. Tot. = 600 mm → Cave 25 Cave 25</p>	RIFERIMENTI ORIGINALI		 <p>← Lungh. Tot. = 966 mm → Cave 25 Cave 25</p>	
	51815194	21026993 51822813 55214684		Paraolio Ø 30 Fusello L/C 430mm
LATO SX	FI 01128		FI 01129	LATO DX
NOTE Fonico Ø 51				

Doblò

1.9 JTD 77/88Kw
1.3 Multijet 51/55Kw2001>
2004>← Lungh. Tot. = 615 mm →
Cave 25 Cave 24

LATO SX

FI 00164

RIFERIMENTI ORIGINALI

46307674

46307678
51806760
51832278← Lungh. Tot. = 935 mm →
Cave 24 Cave 25

FI 00165

LATO DX

NOTE Fonico Ø 51

Doblò

1.4 Natural Power 88Kw
1.6 D Multijet

2010> | 2.0 D 99Kw

02/2010> |

← Lungh. Tot. = 605 mm →
Cave 27 Cave 25

LATO SX

FI 01126

RIFERIMENTI ORIGINALI

51822814
5193366955214685
51933670
55214684

Paraolio L/C Ø 32

Paraolio Ø 30
Fusello L/C 432mm← Lungh. Tot. = 973 mm →
Cave 25 Cave 27

FI 01127

LATO DX

NOTE Fonico Ø 59

Ducato

1.8 49/51Kw
1.9 D 50/51Kw>1994 | 2.0 58Kw
>1994 | 2.5 D-TD 54/55>1994 |
>1994 |← Lungh. Tot. = 700 mm →
Cave 28 Cave 25

LATO SX

FI 00125

RIFERIMENTI ORIGINALI

327248
96074111809607411480
96184035← Lungh. Tot. = 1069 mm →
Cave 25 Cave 28

FI 00126

LATO DX

NOTE

Ducato

1.8
2.0>1987 | 2.5 D-TD
>1987 |

>1987 |

← Lungh. Tot. = 693 mm →
Cave 28 Cave 25

LATO SX

CI 00119

RIFERIMENTI ORIGINALI

9607411480
9559529280
96173032809559529480
9555511780
95555117
9607411180← Lungh. Tot. = 1063 mm →
Cave 25 Cave 28

CI 00120

LATO DX

NOTE

Ducato	1.8 2.0	1987> 2.5 D-TD 1987>	1987>
	RIFERIMENTI ORIGINALI		
← Lungh. Tot. = 702 mm → Cave 28 Cave 25	327248 9607411180 Fusello 112	9559529480 9555511780 95555117 9607411180 Fusello 112	← Lungh. Tot. = 1070mm → Cave 25 Cave 28
LATO SX FI 00125			CI 00124 LATO DX

NOTE

Ducato	1.9 D 51Kw 1.9 TD 60Kw	1994> 2.0 80Kw 1994> 2.5 D 62Kw	1994> 1994>
	RIFERIMENTI ORIGINALI		
← Lungh. Tot. = 765 mm → Cave 28 Cave 37	32726K* 3272CH* 3272J0* 3272J2 3272J3* 10-14 q.li	327309* 327310* 32735S 3273CK 3273Q5 3273Q7 3273Q8 A = ABS 54 10-14 q.li	← Lungh. Tot. = 1065 mm → Cave 37 Cave 28
LATO SX FI 00127 - FI 00127/A*			FI 00128 - FI 00128/A* LATO DX



NOTE

Ducato	2.0 80Kw 2.3 JTD 81Kw	1994> 2.5 TDI 80Kw 04/02> 2.5 D 62Kw	1994> 2.8 JTD 94Kw 1994>	>2003
	RIFERIMENTI ORIGINALI			
← Lungh. Tot. = 755 mm → Cave 28 Cave 41	1495541080 3272 32727K* 3273CK* 3272CL* 3272J1* 3272J5* 10-14 q.li	1495542080 3273CK* 3273Q6* 3273R0* 3273ST* A = ABS 54 10-14 q.li	← Lungh. Tot. = 1075 mm → Cave 41 Cave 28	
LATO SX FI 00129 - FI 00129/A			FI 00130 - FI 00130/A LATO DX	



NOTE

Ducato	2.0 80Kw 2.3 JTD 81Kw	1994> 2.5 D 62Kw 2003> 2.5 TDI 85/88Kw	1994> 2.8 D 64Kw 1994> 2.8 TDI 90Kw	1994> 2.8 JTD 94Kw 1994>	>2005
	RIFERIMENTI ORIGINALI				
← Lungh. Tot. = 765 mm → Cave 35 Cave 41	3272J2 1478551080 3272CN 3272J1* 1463107080* 3272CK* 18 q.li	3273Q7 1478552080* 32735V* A = ABS 54 18 q.li	← Lungh. Tot. = 1080 mm → Cave 41 Cave 35		
LATO SX FI 00131 - FI 00131/A			FI 00132 - FI 00132/A LATO DX		



NOTE

Ducato	2.2 D 74Kw	07/2006>		
	RIFERIMENTI ORIGINALI			
	1349789080 3272PA 3272PC 71790991	1349786080 3273PJ 3273PK 71791000		
← Lungh. Tot. = 813 mm → Cave 35 Cave 41	Fusello L/C 405mm			← Lungh. Tot. = 1145 mm → Cave 41 Cave 35
LATO SX	FI 01049			FI 01050 LATO DX



NOTE

Ducato	3.0 107/114Kw 3.0 116Kw	07/2006> 07/2006>	3.0 100Kw 2009>	
	RIFERIMENTI ORIGINALI			
	1355334080 3272PF 3272SS 71793299	1355333080 3273PN 3273PX 71791061		
← Lungh. Tot. = 752 mm → Cave 35 Cave 31	Fusello L/C 525mm			← Lungh. Tot. = 1203 mm → Cave 31 Cave 35
LATO SX	FI 01016			FI 01017 LATO DX



NOTE



Ducato	2.0 D 85Kw 2.3 96Kw	2011> 2011>	2.3 109Kw 2011>	
	RIFERIMENTI ORIGINALI			
← Lungh. Tot. = 755 mm → Cave 35 Cave 31	Fusello L/C 445mm			← Lungh. Tot. = 1112 mm → Cave 31 Cave 35
LATO SX	FI 01018			FI 01019 LATO DX



NOTE



Ducato	2.2 JTD 88Kw	07/2006>		
	RIFERIMENTI ORIGINALI			
← Lungh. Tot. = 795 mm → Cave 35 Cave 41	Fusello L/C 405mm			← Lungh. Tot. = 1165 mm → Cave 41 Cave 35
LATO SX	FI 01051			FI 01052 LATO DX

NOTE

Fiorino 1.3 D 55Kw Qubo 1.3 D 55Kw		2008>	
 <p>← Lungh. Tot. = 582 mm → Cave 25 Cave 24</p> <p>LATO SX FI 01031</p>	RIFERIMENTI ORIGINALI 46308521 51808105 46308324 Fusello L/C 380mm		 <p>← Lungh. Tot. = 955 mm → Cave 24 Cave 25</p> <p>FI 01032 LATO DX</p>
	<p>NOTE Fonico Ø 51</p>		



Fiorino 1.4 Benzina 54/57Kw			
 <p>← Lungh. Tot. = 644 mm → Cave 22 Cave 22</p> <p>LATO SX FI 01053</p>	RIFERIMENTI ORIGINALI 51947026 51947021		 <p>← Lungh. Tot. = 895 mm → Cave 22 Cave 22</p> <p>FI 01054 LATO DX</p>
	<p>NOTE</p>		

Fiorino 1.4 Natural Power 57Kw		2009>	
 <p>← Lungh. Tot. = 645 mm → Cave 22 Cave 22</p> <p>LATO SX AR 00158</p>	RIFERIMENTI ORIGINALI 55700560 55700559 55700562 55700557 51754514 51754513		 <p>← Lungh. Tot. = 890 mm → Cave 22 Cave 22</p> <p>AR 00159 LATO DX</p>
	<p>NOTE</p>		

Fiorino 1.3 M.Jet 70Kw		2009>	
 <p>← Lungh. Tot. = 610 mm → Cave 25 Cave 24</p> <p>LATO SX FI 01037</p>	RIFERIMENTI ORIGINALI 51896520 55228304 Fusello L/C 390mm		 <p>← Lungh. Tot. = 920 mm → Cave 24 Cave 25</p> <p>FI 01038 LATO DX</p>
	<p>NOTE</p>		



Fiorino		1.4 54Kw 1.4 54Kw	2007> 2008>		
		RIFERIMENTI ORIGINALI			
		3272SJ 3272SK			
← Lungh. Tot. = 650 mm → Cave 22 Cave 22					← →
LATO SX	PE 01150			PE 01151	LATO DX
NOTE					

Fiorino		1.3 D 55Kw	2014>		
		RIFERIMENTI ORIGINALI			
		51975576		Fusello L/C 395	
← Lungh. Tot. = 602 mm → Cave 25 Cave 24					← Lungh. Tot. = 918 mm → Cave 24 Cave 25
LATO SX	FI 01041			FI 01042	LATO DX
NOTE					

Freemont		2.0 JTD 103KW	06/11> 2011>		
		RIFERIMENTI ORIGINALI			
		52123583 K68079560AB		05273546 K52123588AA	
← Lungh. Tot. = 655 mm → Cave 32 Cave 25					← Lungh. Tot. = 525 mm → Cave 25 Cave 32
LATO SX	FI 01136			FI 01137	LATO DX
NOTE					

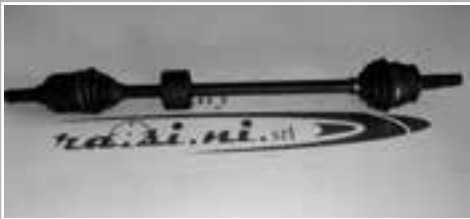
Freemont					
		RIFERIMENTI ORIGINALI			
← →					← →
LATO SX	FI 01065			FI 01066	LATO DX
NOTE					

Grande Punto 1.2 48Kw		2005>	
 <p>Lungh. Tot. = 650 mm Cave 22 Cave 22</p> <p>LATO SX FI 00196</p>	RIFERIMENTI ORIGINALI		 <p>Lungh. Tot. = 890 mm Cave 22 Cave 22</p> <p>FI 00197 LATO DX</p>
	51754514	51754513 55700559	
NOTE Fonico Ø 51			

Grande Punto 1.2 48Kw 1.4 55Kw		2007> 2006>	1.4 57Kw	2005>	Evo 1.2 48/50Kw Evo 1.4 55/57Kw
 <p>Lungh. Tot. = 644 mm Cave 22 Cave 22</p> <p>LATO SX FI 01053</p>	RIFERIMENTI ORIGINALI		 <p>Lungh. Tot. = 895 mm Cave 22 Cave 22</p> <p>FI 01054 LATO DX</p>		
	51754514 55700560 55700562	51754513 55700557 55700562			
NOTE Fonico Ø 51					

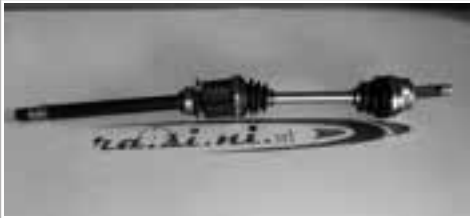
Grande Punto 1.4 TJET 88Kw		2007	
 <p>Lungh. Tot. = 610 mm Cave 25 Cave 24</p> <p>LATO SX FI 01190</p>	RIFERIMENTI ORIGINALI		 <p>Lungh. Tot. = 920 mm Cave 24 Cave 25</p> <p>FI 01191 LATO DX</p>
		55207526	
NOTE			

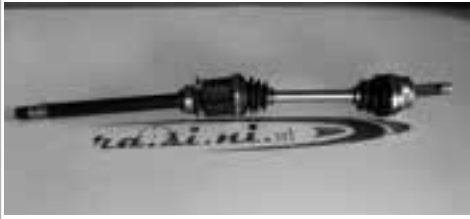
Grande Punto 1.3 Multijet 55Kw 1.3 Multijet 66Kw 5 marce		2005> 2005>	
 <p>Lungh. Tot. = 623 mm Cave 25 Cave 24</p> <p>LATO SX FI 01012</p>	RIFERIMENTI ORIGINALI		 <p>Lungh. Tot. = 905 mm Cave 24 Cave 25</p> <p>FI 01013 LATO DX</p>
	46308345 51808106	46308329 46308522	
NOTE Fonico Ø 51			

Grande Punto

1.3 Multijet 66Kw

2005> | Evo 1.3 MJT 66Kw 6 speed



← Lungh. Tot. = 577 mm →
Cave 25 Cave 25

LATO SX

FI 00198

RIFERIMENTI ORIGINALI

51808107
51785204
7179305746308437
46308524
51785203
46308410

Fusello L/C 400mm



← Lungh. Tot. = 952 mm →
Cave 25 Cave 25

FI 00199

LATO DX

NOTE Fonico Ø 51

Grande Punto

1.4 Abarth 114Kw
1.6 MJET 88Kw2007> | 1.9 D MJet 88/96Kw
2008>

2005>



← Lungh. Tot. = 590 mm →
Cave 25 Cave 25

LATO SX

AR 00165

RIFERIMENTI ORIGINALI

51787863

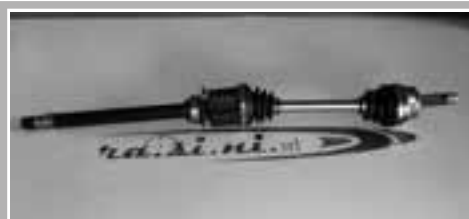
51787861
51807675
71745016

← Lungh. Tot. = 955 mm →
Cave 25 Cave 25

AR 00166

LATO DX

NOTE

Idea

1.2 16V 59Kw
1.4 16V 70Kw2004> |
2004>

← Lungh. Tot. = 635 mm →
Cave 22 Cave 22

LATO SX

FI 00166

RIFERIMENTI ORIGINALI

46308093
46308494
51753392

46308147

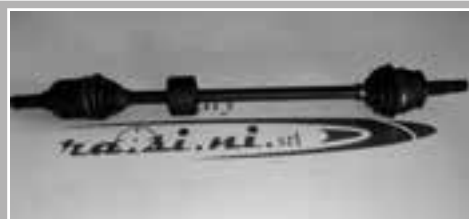

← Lungh. Tot. = 867 mm →
Cave 22 Cave 22

FI 00167

LATO DX

NOTE Fonico Ø 51

Idea

1.3 Multijet 51Kw

2004> |



← Lungh. Tot. = 502 mm →
Cave 25 Ø 100

LATO SX

FI 00173

RIFERIMENTI ORIGINALI

46308079

46308080
71785664



← Lungh. Tot. = 522 mm →
Ø 100 Cave 25



FI 00174

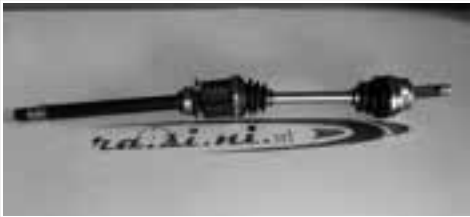

LATO DX

NOTE Fonico Ø 51

Idea	1.3 MJT 66Kw	2005>		
 <p>← Lungh. Tot. = 580 mm → Cave 25 Cave 24</p> <p>LATO SX FI 00177</p>	RIFERIMENTI ORIGINALI		 <p>← Lungh. Tot. = 900 mm → Cave 24 Cave 25</p> <p>FI 00178 LATO DX</p>	
	46308523 46308409	51785203 46308524 46308410 46308437		
NOTE Fonico Ø 51				

Idea	1.6 MJet 88Kw	05/2008>		
 <p>← Lungh. Tot. = 610 mm → Cave 25 Cave 25</p> <p>LATO SX FI 01130</p>	RIFERIMENTI ORIGINALI		 <p>← Lungh. Tot. = 877 mm → Cave 25 Cave 25</p> <p>FI 01131 LATO DX</p>	
	51800456	51800455		Fusello L/C 377mm
NOTE Fonico Ø 51				

Idea	1.9 MJT 74Kw	2004>		
 <p>← Lungh. Tot. = 607 mm → Cave 25 Cave 34</p> <p>LATO SX FI 00188</p>	RIFERIMENTI ORIGINALI		 <p>← Lungh. Tot. = 870 mm → Cave 34 Cave 25</p> <p>FI 00189 LATO DX</p>	
	51813089	46308045 46308069 51813090		
NOTE Fonico Ø 51				

Marea	1.6 16v 76Kw	96>99		
 <p>← Lungh. Tot. = 600 mm → Cave 25 Rullo Ø 32</p> <p>LATO SX FI 00169 - FI 00169/A*</p>	RIFERIMENTI ORIGINALI		 <p>← Lungh. Tot. = 930 mm → Rullo Ø 32 Cave 25</p> <p>FI 00170 - FI 00170/A* LATO DX</p>	
	46307081	46307073		A = ABS 44
NOTE				

Marea

1.6 16v 76Kw

96>99



← Lungh. Tot. = 600 mm →
Cave 25 Ruillo Ø 32

LATO SX

FI 01055

RIFERIMENTI ORIGINALI

46307485

46307487



← Lungh. Tot. = 930 mm →
Ruillo Ø 32 Cave 25

FI 01056

LATO DX

NOTE Fonico Ø 51

Marea

2.0 20v 108Kw

1996>



← Lungh. Tot. = 470 mm →
Cave 25 Ø 100

LATO SX

FI 00168 - FI 00168/A*

RIFERIMENTI ORIGINALI

46307323

46307325*

A = ABS 44



← Lungh. Tot. = 470 mm →
Ø 100 Cave 25

FI 00168 - FI 00168/A*

LATO DX

NOTE

Marea

1.9 TD 55Kw

96>99



← Lungh. Tot. = 485 mm →
Cave 25 Ø 100

LATO SX

FI 01007 - FI 01007/A*

RIFERIMENTI ORIGINALI

46307011*

A = ABS 44



← Lungh. Tot. = →
Ø 100 Cave 25

FI 01007 - FI 01007/A*

LATO DX

NOTE

Marea

1.8 16v 83Kw
1.9 TD 74Kw

96>99

96>99



← Lungh. Tot. = 470 mm →
Cave 25 Ø 72 Stellare

LATO SX

FI 00118 - FI 00118/A*

RIFERIMENTI ORIGINALI

46307101*
46307102

A = ABS 44



← Lungh. Tot. = 470 mm →
Ø 72 Stellare Cave 25

FI 00118 - FI 00118/A*

LATO DX

NOTE

Marea	1.8 16v 83Kw 1.9 JTD 77Kw	1999> 1999>		
	RIFERIMENTI ORIGINALI			
	46307360			
← Lungh. Tot. = 465 mm Cave 25 Ø 72 Stellare →			← Lungh. Tot. = 465 mm Ø 72 Stellare →	→ Cave 25
LATO SX	FI 00117		FI 00117	LATO DX
NOTE Fonico Ø 51				

Marea	2.4 JTD 96Kw	1999>		
	RIFERIMENTI ORIGINALI			
	46307362			
← Lungh. Tot. = 460 mm Cave 25 Ø 108 H 49 →			← Lungh. Tot. = 460 mm Ø 108 H 49 →	→ Cave 25
LATO SX	FI 00119		FI 00119	LATO DX
NOTE Fonico Ø 59				

Marea	2.4 TD 91Kw	1996>		
	RIFERIMENTI ORIGINALI			
	46307017 46307195			
← Lungh. Tot. = 460 mm Cave 25 Ø 108 H 49 →		A = ABS 44	← Lungh. Tot. = 460 mm Ø 108 H 49 →	→ Cave 25
LATO SX	FI 00176 - FI 00176/A		FI 00176 - FI 00176/A	LATO DX
NOTE				



Multipla	1.6 16v 76Kw 1.6 Bipower 76Kw	1999> 2002>	1.6 Blue Power 70Kw 2002>	
	RIFERIMENTI ORIGINALI			
	46307098	46307096 46519876		
← Lungh. Tot. = 605 mm Cave 25 Rullo Ø 32 →			← Lungh. Tot. = 945 mm Rullo Ø 32 →	→ Cave 25
LATO SX	FI 00134		FI 00135	LATO DX
NOTE Fonico Ø 51				



Multipla	1.9 JTD 77/81/85Kw	1999>		
	RIFERIMENTI ORIGINALI			
← Lungh. Tot. = 485 mm → Cave 25 Ø 72 Stellare	46538020			← Lungh. Tot. = 496 mm → Ø 100 Cave 25
LATO SX	FI 00116			FI 01003 LATO DX
NOTE Fonico Ø 51 - Fino al telaio n.2262921				



Multipla	1.9 jtd 77/81/85 kw	1999>		
	RIFERIMENTI ORIGINALI			
← Lungh. Tot. = 496 mm → Cave 25 Ø 100				← Lungh. Tot. = 496 mm → Ø 100 Cave 25
LATO SX	FI 01003			FI 01003 LATO DX
NOTE Dal telaio n.2262922				

Panda	1.1 40Kw 1.2 44Kw	2003> 2003>	1.2 Cambio Automatico 2003>	
	RIFERIMENTI ORIGINALI			
← Lungh. Tot. = 590 mm → Cave 22 Cave 22	46308274	46308008 46308259		← Lungh. Tot. = 825 mm → Cave 22 Cave 22
LATO SX	FI 00141			FI 00142 LATO DX
NOTE Fonico Ø 47				

Panda	1.2 4x4 44Kw 1.3 M.Jet 4x4 51Kw	2004> 2004>	1.3 M.Jet 55Kw 2010>	
	RIFERIMENTI ORIGINALI			
← Lungh. Tot. = 590 mm → Cave 25 Cave 22	46308227	46308229	Paraolio Ø36 Fusello 65mm	← Lungh. Tot. = 820 mm → Cave 22 Cave 25
LATO SX	FI 01004			FI 01008 LATO DX
NOTE Fonico Ø 51				

Panda 1.2 51Kw		02/2012>	
 <p>← Lungh. Tot. = 625 mm → Cave 22 Cave 22</p> <p>LATO SX FI 01035</p>	RIFERIMENTI ORIGINALI		 <p>← Lungh. Tot. = 850 mm → Cave 22 Cave 22</p> <p>FI 01036 LATO DX</p>
	51902278	51839645	
NOTE Fonico Ø 51			

Panda 1.3 MJT 51Kw 1.2 Bipower		2004> 2007>	
 <p>← Lungh. Tot. = 600 mm → Cave 25 Cave 22</p> <p>LATO SX FI 00183</p>	RIFERIMENTI ORIGINALI		 <p>← Lungh. Tot. = 825 mm → Cave 22 Cave 25</p> <p>FI 00184 LATO DX</p>
	46308275	46303261 46308221 46308229	
NOTE Fonico Ø 51			

Panda 1.3 MJT 70Kw		2011>	
 <p>← Lungh. Tot. = 570 mm → Cave 25 Cave 24</p> <p>LATO SX FI 01124</p>	RIFERIMENTI ORIGINALI		 <p>← Lungh. Tot. = 880 mm → Cave 24 Cave 25</p> <p>FI 01125 LATO DX</p>
	51839650	51854039 Fusello L/C 360mm	
NOTE Fonico Ø 51			

Panda 1.3 D M.Jet 55Kw 4x4		2012>	
 <p>← Cave 25 Cave 24 →</p> <p>LATO SX FI 01073</p>	RIFERIMENTI ORIGINALI		 <p>← Lungh. Tot. = 875 mm → Cave 24 Cave 25</p> <p>FI 01074 LATO DX</p>
		51839646	
NOTE			

Panda Cross

1.3 DM Jet 59Kw 4x4 2012>



← Cave 25 →
Cave 24

LATO SX

FI 01075

RIFERIMENTI ORIGINALI

51950793



← Cave 24 →
Cave 25

FI 01076

LATO DX

NOTE

Punto

1.1 40Kw
1.2 43/44/54Kw93>99 | 1.2 16v 63Kw
93>99 | 1.6 65Kw93>99 | 1.7 D 42Kw
93>99

93>99



← Lungh. Tot. = 586 mm →
Cave 22 Cave 22

LATO SX

FI 00108 - FI 00108/A

RIFERIMENTI ORIGINALI

7739015

7739016

A = ABS 44

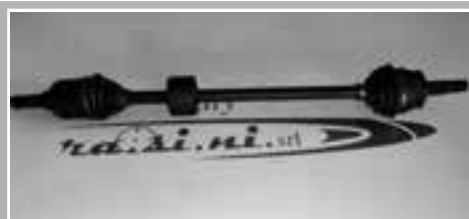

← Lungh. Tot. = 870 mm →
Cave 22 Cave 22

FI 00109 - FI 00109/A

LATO DX

NOTE ABS 44D su richiesta

Punto

1.9 D 44Kw

1999>



← Lungh. Tot. = 570 mm →
Cave 22 Rullo Ø 32

LATO SX

FI 00151

RIFERIMENTI ORIGINALI

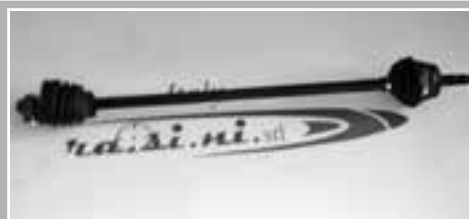
46307642
46307785
4630815846307471
46307786
46308156

← Lungh. Tot. = 880 mm →
Rullo Ø 32 Cave 22

FI 00152

LATO DX

NOTE Fonico Ø 51

Punto

1.4 GT Turbo 98Kw 93>99
1.7 TD S-SX-ELX 51/52Kw 93>99

← Lungh. Tot. = 480 mm →
Cave 25 Ø 100

LATO SX

FI 00112 - FI 00112/A*

RIFERIMENTI ORIGINALI

46307112
46307131*
46307174*46307149
46307180*
7782545*

A = ABS 44



← Lungh. Tot. = 500 mm →
Ø 100 Cave 25

FI 00113 - FI 00113/A*

LATO DX

NOTE ABS 44D su richiesta

Punto	1.2 8v 44Kw 1.2 16v 59Kw	1999> 1999>		
	RIFERIMENTI ORIGINALI			
	46307566 46307565	46307792		
← Lungh. Tot. = 610 mm → Cave 22 Cave 22			← Lungh. Tot. = 840 mm → Cave 22 Cave 22	
LATO SX	FI 00110		FI 00111	LATO DX

NOTE Fonico Ø 51

Punto	1.3 JTD 59/63Kw 1.9 JTD 63Kw	1999> 2001>	1.9 JTD 44Kw* * Fino al telaio n.0822487	2003>
	RIFERIMENTI ORIGINALI			
	46307687	46307688		
← Lungh. Tot. = 460 mm → Cave 25 L.C. Stellare Ø 72			← Lungh. Tot. = 495 mm → Ø 100 Cave 25	
LATO SX	FI 00133		FI 00147	LATO DX

NOTE Fonico Ø 51

Punto	1.3 Multijet 51Kw* * Dal telaio n.0822488	2003>		
	RIFERIMENTI ORIGINALI			
	170922 46308405 51808314	170923 46308404 51808313		
← Lungh. Tot. = 560 mm → Cave 25 Cave 24		Fusello L/C 380mm	← Lungh. Tot. = 880 mm → Cave 24 Cave 25	
LATO SX	FI 01005		FI 01006	LATO DX

NOTE Fonico Ø 51

Punto	1.9 JTD 74Kw	2003>		
	RIFERIMENTI ORIGINALI			
	170962	170963		
← Lungh. Tot. = 590 mm → Cave 25 Cave 34			← Lungh. Tot. = 850 mm → Cave 34 Cave 25	
LATO SX	FI 01057		FI 01058	LATO DX

NOTE

Qubo	1.4 54Kw 1.4 54Kw	2007> 2008>	RIFERIMENTI ORIGINALI	
			3272SJ 3272SK	
← Lungh. Tot. = 650 mm → Cave 22 Cave 22			Fusello L/C 58	Fusello L/C 97
LATO SX	PE 01150			
				← Lungh. Tot. = 882 mm → Cave 22 Cave 22
				LATO DX
				PE 01151

NOTE

Qubo	1.3 D 55Kw Qubo 1.3 D 55Kw	2008>	RIFERIMENTI ORIGINALI	
			46308521	51808105 46308324
← Lungh. Tot. = 582 mm → Cave 25 Cave 24				Fusello L/C 380mm
LATO SX	FI 01031			
				← Lungh. Tot. = 955 mm → Cave 24 Cave 25
				LATO DX
				FI 01032



NOTE Fonico Ø 51



Qubo	1.4 Natural Power 57Kw	2009>	RIFERIMENTI ORIGINALI	
			55700560 55700562 51754514	55700559 55700557 51754513
← Lungh. Tot. = 645 mm → Cave 22 Cave 22				
LATO SX	AR 00158			
				← Lungh. Tot. = 890 mm → Cave 22 Cave 22
				LATO DX
				AR 00159

NOTE



Qubo	1.3 M.Jet 70Kw	2009>	RIFERIMENTI ORIGINALI	
			51896520	55228304
← Lungh. Tot. = 610 mm → Cave 25 Cave 24				Fusello L/C 390mm
LATO SX	FI 01137			
				← Lungh. Tot. = 920 mm → Cave 24 Cave 25
				LATO DX
				FI 01138

NOTE

Sedici 1.6 16v 77Kw		06/2006>	
 <p>← Lungh. = 634 mm → Cave 28 Cave 26</p> <p>LATO SX FI 01112</p>	RIFERIMENTI ORIGINALI		 <p>← Lungh. Tot. = 724 mm → Cave Int. 26 Cave 28</p> <p>FI 01113 LATO DX</p>
	4410279J00	4410179J21	
NOTE Fonico Ø 48			

Sedici 1.9 MJ 88Kw		06/2006>	
 <p>← Lungh. = 619 mm → Cave 28 Cave 28</p> <p>LATO SX FI 01114</p>	RIFERIMENTI ORIGINALI		 <p>← Lungh. Tot. = 590 mm → Cave Int. 26 Cave 28</p> <p>FI 01115 LATO DX</p>
	71746603 4410279J60	71747566 4410179J60	
NOTE Fonico Ø 48			

Sedici 1.6 16v 4x4 Posteriori 1.9 D MJT Posteriori			
 <p>← Lungh. Tot. = 661 mm → Cave 24</p> <p>LATO SX FI 01134</p>	RIFERIMENTI ORIGINALI		 <p>← Lungh. Tot. = 755 mm → Cave 24</p> <p>FI 01135 LATO DX</p>
NOTE			

Sedici 1.6 16v 78/88Kw 1.6 16v 4x4 88Kw		2006> 2006>	
 <p>← Lungh. Tot. = 610 mm → Cave 28 Cave 26</p> <p>LATO SX FI 01160</p>	RIFERIMENTI ORIGINALI		 <p>← Lungh. Tot. = 700 mm → Cave int. 26 Cave 28</p> <p>FI 01161 LATO DX</p>
	4410279J00 71742703	4410179JC0 717443873	
NOTE			

Seicento

1.1 40Kw

1998>



← Lungh. Tot. = 554 mm →
Cave 22 Cave 22

LATO SX **FI 01059 - FI 01059/A**

RIFERIMENTI ORIGINALI

46476612

46409864



← Lungh. Tot. = 775 mm →
Cave 22 Cave 22

FI 01060 - FI 01060/A LATO DX**NOTE** A= Fonico Ø 47 dal telaio n.0047304

Serie 200

242 15D-242 18D
242 E 15D74>91 | 242 E 18D
74>91

74>91



← Lungh. Tot. = 560 mm →
Cave 29 Ø 145

LATO SX **FI 00124**

RIFERIMENTI ORIGINALI

5540795
95540795
95582440

← Lungh. Tot. = 560 mm →
Ø 145 Cave 29

FI 00124 LATO DX**NOTE**

Stilo

1.9 JTD 66/85/88Kw

2004



← Lungh. Tot. = 635 mm →
Cave 25 Cave 34

LATO SX **FI 01028**

RIFERIMENTI ORIGINALI



← Lungh. Tot. = 930 mm →
Cave 34 Cave 25

FI 01029 LATO DX**NOTE**

Stilo

1.8 98Kw
1.9 JTD 59Kw01>06
02>06

← Lungh. Tot. = 510 mm →
Cave 25 Cave 100

LATO SX **FI 01168**



RIFERIMENTI ORIGINALI

46307666
4630790046307667
46307904

← Lungh. Tot. = 490 mm →
Cave 100 Cave 25

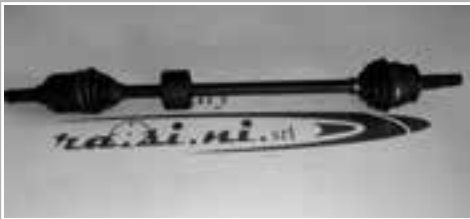
FI 01169 LATO DX**NOTE**

Stilo 1.2 16v 59Kw		2002>	
 <p>Lungh. Tot. = 660 mm Cave 22 Cave 22</p> <p>LATO SX FI 00171</p>	RIFERIMENTI ORIGINALI 46307703 46307707		 <p>Lungh. Tot. = 915 mm Cave 22 Cave 22</p> <p>FI 00172 LATO DX</p>
	<p>NOTE Fonico Ø 51</p>		

Stilo 1.6 16v 76Kw		2001>	
 <p>Lungh. Tot. = 635 mm Cave 25 Cave 22</p> <p>LATO SX FI 00190</p>	RIFERIMENTI ORIGINALI 46307851 46308034 46307852 46308035		 <p>Lungh. Tot. = 938 mm Cave 22 Cave 25</p> <p>FI 00191 LATO DX</p>
	<p>NOTE Fonico Ø 51</p>		

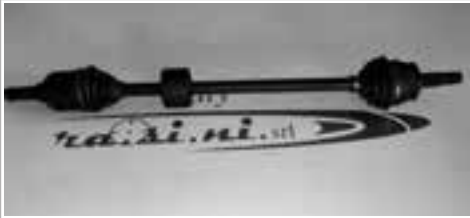
Stilo 1.4 16v 66/70Kw		2004>	
 <p>Lungh. Tot. = 655 mm Cave 25 Cave 22</p> <p>LATO SX FI 00192</p>	RIFERIMENTI ORIGINALI 46308116 46308112 46308115		 <p>Lungh. Tot. = 920 mm Cave 22 Cave 25</p> <p>FI 00193 LATO DX</p>
	<p>NOTE Fonico Ø 51</p>		

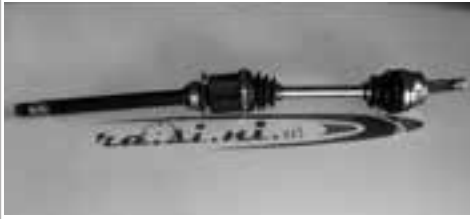
Stilo 1.9 JTD 85Kw		2001>		1.9 JTD 88Kw fino al telaio n.653437		2005>	
 <p>Lungh. Tot. = 635 mm Cave 25 Cave 34</p> <p>LATO SX FI 00143</p>	RIFERIMENTI ORIGINALI 46307864 46307863 46307910 46307909 46308178 46308066 46308179 46308180		Fusello L/C 410mm		 <p>Lungh. Tot. = 930 mm Cave 34 Cave 25</p> <p>FI 00144 LATO DX</p>		
	<p>NOTE Fonico Ø 51</p>						

Stilo

1.9 Multijet 88/110Kw

2005>



← Lungh. Tot. = 630 mm →
Cave 25 Cave 25

LATO SX

FI 01014

RIFERIMENTI ORIGINALI



← Lungh. Tot. = 930 mm →
Cave 25 Cave 25

FI 01015

LATO DX

NOTE Dal telaio n.653438 - Fonico Ø 51

Tipo

1.4 70Kw

2015



← Lungh. Tot. = 680 mm →
Cave 25 Cave 22

LATO SX

FI 01166

RIFERIMENTI ORIGINALI

51983793

51983845

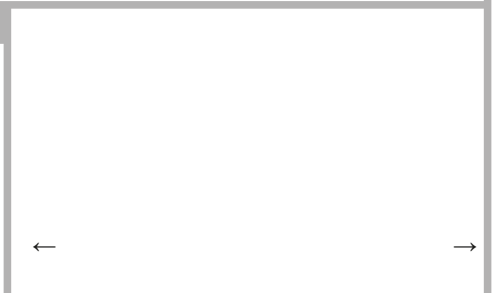

← Lungh. Tot. = 680 mm →
Cave 25 Cave 22

FI 01167

LATO DX

NOTE

Tipo



← Lungh. Tot. = 650 mm →
Cave 25 Cave 24

LATO SX

FI 01067

RIFERIMENTI ORIGINALI

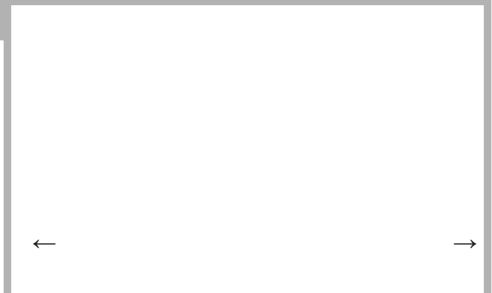

← Lungh. Tot. = 650 mm →
Cave 25 Cave 24

FI 01068

LATO DX

NOTE

Tipo

1.6 81Kw
1.6 M.Jet 88Kw2016>
2016>

← Lungh. Tot. = 620 mm →
Cave 25 Cave 26

LATO SX

FI 01069

RIFERIMENTI ORIGINALI

51983794

51983847







← Lungh. Tot. = 968 mm →
Cave 26 Cave 25



FI 01070

LATO DX

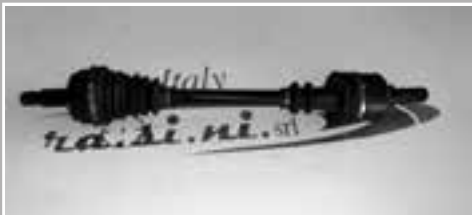
NOTE

Tipo	1.3 M.Jet 70Kw	2015>		
 <p>← Lungh. Tot. = 670 mm → Cave 25 Cave 24</p> <p>LATO SX FI 01116</p>	RIFERIMENTI ORIGINALI 51987807 51963848 Fusello L/C 380mm Paraolio Ø 30		 <p>← Lungh. Tot. = 936 mm → Cave 24 Cave 25</p> <p>LATO DX FI 01117</p>	
	NOTE			

Ulisse - Scudo	1.6 73Kw 1.9 D 50/51Kw	1996> 1996>	2.0 89Kw	1994>
 <p>← Lungh. Tot. = 648 mm → Cave 27 Cave 24</p> <p>LATO SX FI 00120 - FI 00120/A*</p>	RIFERIMENTI ORIGINALI 32721L* 3272M0* 3272P5* 9619947588 Fusello L/C 62		 <p>← Lungh. Tot. = 935 mm → Cave 24 Cave 27</p> <p>LATO DX FI 00121 - FI 00121/A*</p>	
	3273TG* 3273V* 3273W0* 9619947688 A = ABS 48			
NOTE ABS 48D su richiesta				

Ulisse - Scudo	1.9 TD 66/68Kw 2.1 TD 80Kw	1993> 1997>	1.9 TD Scudo 66/68Kw 2.0 Turbo 108Kw	1996> 1994>
 <p>← Lungh. Tot. = 640 mm → Cave 27 Cave 37</p> <p>LATO SX FI 00122 - FI 00122/A*</p>	RIFERIMENTI ORIGINALI 32723L* 3272K7* 96174048188 Fusello L/C 370mm A = ABS 48		 <p>← Lungh. Tot. = 940 mm → Cave 37 Cave 27</p> <p>LATO DX FI 00123 - FI 00123/A</p>	
	327306 327315 9617408288			
NOTE ABS 48D su richiesta				

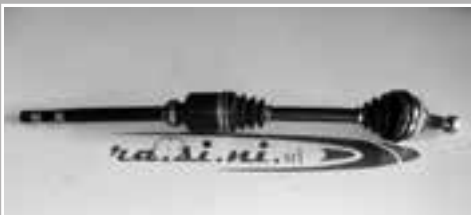
Ulisse - Scudo	2.0 JTD 80Kw 2.0 JTD Scudo 66/80Kw	99>06 1999>		
 <p>← Lungh. Tot. = 630 mm → Cave 27 Cave 37</p> <p>LATO SX FI 00136</p>	RIFERIMENTI ORIGINALI 32724L 32729C Fusello L/C 370mm		 <p>← Lungh. Tot. = 945 mm → Cave 37 Cave 27</p> <p>LATO DX FI 00137</p>	
	32733Q 32735Z 9645249380			
NOTE ABS 48D				

Ulisse - Scudo

1.6 Multijet 66Kw

2007>



← Lungh. Tot. = 668 mm →
Cave 28 Cave 24

LATO SX

FI 01026

RIFERIMENTI ORIGINALI

3272GG
3272GH3273EG
3273FA

← Lungh. Tot. = 955 mm →
Cave 24 Cave 28

FI 01027

LATO DX

NOTE Fonico Ø 58,5

Ulisse - Scudo

2.0 JTD 88Kw

2006>



← Lungh. Tot. = 652 mm →
Cave 28 Cave 37

LATO SX

FI 01020

RIFERIMENTI ORIGINALI

1497187088

1497188088
71792564

L/C 400



← Lungh. Tot. = 985 mm →
Cave 37 Cave 28

FI 01021

LATO DX

NOTE Fonico Ø 58,5

Viaggio

RIFERIMENTI ORIGINALI

← →

LATO SX

FI 01071

← →

FI 01072

LATO DX

NOTE



RIFERIMENTI ORIGINALI

← →



LATO SX

LATO DX



NOTE

Escort	1.1 37/40Kw 1.3 44Kw	82>90 1.4 55Kw 82>90 1.6 D 40Kw	86>90 1.6 Turbo 97Kw 84>90 1.8 44Kw	82>90 86>90
	RIFERIMENTI ORIGINALI			
← Lungh. Tot. = 590 mm → Cave 23 Cave 23			← Lungh. Tot. = 865 mm → Cave 23 Cave 23	
LATO SX FO 00133			FO 00134 LATO DX	



NOTE

Escort	1.3 44Kw	90>91		
	RIFERIMENTI ORIGINALI			
← Lungh. Tot. = 600 mm → Cave 23 Cave 23			← Lungh. Tot. = 895 mm → Cave 23 Cave 23	
LATO SX FO 00135			FO 00136 LATO DX	

NOTE

Escort	2.0 Cosworth 162Kw	1993>		
	RIFERIMENTI ORIGINALI			
← Lungh. Tot. = 580 mm → Cave 23 Cave 23			← Lungh. Tot. = 580 mm → Cave 23 Cave 23	
LATO SX FO 00137			FO 00137 LATO DX	

NOTE

Escort	1.4 52Kw 1.6 65/66Kw	90>95 1.8 44Kw 90>95	90>95	
	RIFERIMENTI ORIGINALI			
← Lungh. Tot. = 607 mm → Cave 25 Cave 23	5024574 6596778 6596779	5024569 5026652 6596773	← Lungh. Tot. = 905 mm → Cave 23 Cave 25	
LATO SX FO 00121			FO 00122 LATO DX	

NOTE ABS 56D su richiesta

Escort	1.8 TD 66Kw 1.8 I 16v 77Kw	93>95 93>95	2.0 RS 2000 16v 110Kw	92>95
	RIFERIMENTI ORIGINALI			
← Lungh. Tot. = 594 mm → Cave 25 Cave 26	5024576	5024570	← Lungh. Tot. = 907 mm → Cave 26 Cave 25	
LATO SX	FO 00123		FO 00124	LATO DX

NOTE

Escort	1.8 TD 66Kw 1.8 I 16v 77Kw	97>98 97>98	2.0 16v 110Kw	97>98
	RIFERIMENTI ORIGINALI			
← Lungh. Tot. = 595 mm → Cave 25 Cave 26			← Lungh. Tot. = 905 mm → Cave 26 Cave 25	
LATO SX	FO 00138		FO 00139	LATO DX



NOTE Fonico Ø 56,6

Escort	1.8 TD 66Kw 1.8 I 16v 77Kw	95>96 95>96	2.0 16v 110Kw	95>96
	RIFERIMENTI ORIGINALI			
← Lungh. Tot. = 595 mm → Cave 25 Cave 26			← Lungh. Tot. = 816 mm → Cave 25 Cave 25	
LATO SX	FO 00138		FO 00140	LATO DX



NOTE

Fiesta	1.0 33Kw 1.1 36Kw	83>89 83>89	1.6 D 40Kw 1.6 XR2 71Kw	83>89 83>89
	RIFERIMENTI ORIGINALI			
← Lungh. Tot. = 577 mm → Cave 23 Cave 23	5018762 5018763 5018764	5018754 5018756 5018757	← Lungh. Tot. = 855 mm → Cave 23 Cave 23	
LATO SX	FO 00131		FO 00132	LATO DX



NOTE

Fiesta	1.3 44/49Kw 1.4 52Kw	91>94 1.6 Turbo 96/98Kw 91>91 1.6 XR2 71Kw	91>90 1.8 D 43/44Kw 1994 1.8 I 16v 77Kw	89>94 1.8 XR2 96Kw 91>94	92>94
	RIFERIMENTI ORIGINALI				
← Lungh. Tot. = 585 mm → Cave 23 Cave 23	5022283 5022285 5026505 6779200	5022284 5022286 5026502 6779184	← Lungh. Tot. = 863 mm → Cave 23 Cave 23		
LATO SX	FO 00105		FO 00106	LATO DX	

NOTE

Fiesta	1.0 33Kw 1.1 37Kw	89>94 89>94			
	RIFERIMENTI ORIGINALI				
← Lungh. Tot. = 585 mm → Cave 23 Cave 23	5022281 5026501	5022282 5026500	← Lungh. Tot. = 865 mm → Cave 23 Cave 23		
LATO SX	FO 00101		FO 00102	LATO DX	

NOTE

Fiesta	1.3 44Kw 1.4 16v 66Kw	94>96 1.6 81Kw 94>96 1.8 D 43/44Kw	94>96 1.8 TD 57Kw 94>96	94>96
	RIFERIMENTI ORIGINALI			
← Lungh. Tot. = 587 mm → Cave 25 Cave 23	1059526	1059517	← Lungh. Tot. = 870 mm → Cave 23 Cave 25	
LATO SX	FO 00103		FO 00104	LATO DX

NOTE ABS 56D su richiesta

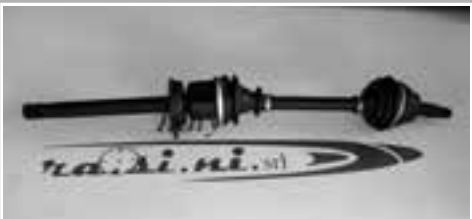
Fiesta	1.4 Techno 1.6 Techno	1994> 1.8 D 44Kw 1994>	96>	
	RIFERIMENTI ORIGINALI			
← Lungh. Tot. = 600 mm → Cave 25 Cave 23	1059524	1059518	← Lungh. Tot. = 810 mm → Cave 25 Cave 25	
LATO SX	FO 00107		FO 00108	LATO DX

NOTE Supporto L/C 3 fori DX

Fiesta 1.2 Techno 1994>		RIFERIMENTI ORIGINALI	
	1059524	1059520 R97FX-3219DA	
← Lungh. Tot. = 600 mm → Cave 25 Cave 23			← Lungh. Tot. = 900 mm → Cave 23 Cave 25
LATO SX FO 00107			FO 00110 LATO DX
NOTE Supporto L/C 2 fori DX			

Fiesta - Fusion Fiesta 1.2 51/55Kw 01>08 Fiesta 1.4 TDCI 50Kw 2002>		Fiesta 1.6 TDC 66Kw 2001> Fusion 1.4 TDCI 50Kw 2002>	
	RIFERIMENTI ORIGINALI		
← Lungh. Tot. = 618 mm → Cave 25 Cave 23	1468576 1506722 1142794 1359345	1468572 1506723 1142790 1359342	← Lungh. Tot. = 915 mm → Cave 23 Cave 25
LATO SX FO 00129			FO 00130 LATO DX
NOTE			

Fiesta - Fusion Fiesta 1.3 8v 44/51Kw 2001> Fiesta 1.4 16v 59Kw 2001>		Fiesta 1.4 16v 59Kw 2001> Fiesta 1.6 16v 74Kw 2001>		Fusion 1.6 16v 74Kw 2001>	
	RIFERIMENTI ORIGINALI				
← Lungh. Tot. = 618 mm → Cave 25 Cave 23	1334285	1334284	← Lungh. Tot. = 920 mm → Cave 23 Cave 25		
LATO SX FO 00192			FO 00193 LATO DX		
NOTE					

Fiesta - Fusion Fiesta 1.4 50/51Kw 2009>		RIFERIMENTI ORIGINALI	
	1799219 25613B437AB 8V51-3B437-CA	1799209 25613B436AE 8V51-3B436-CA	
← Lungh. Tot. = 624 mm → Cave 25 Cave 23			← Lungh. Tot. = 922 mm → Cave 23 Cave 25
LATO SX FO 00172			FO 00173 LATO DX
NOTE			

Focus

1.6 C/Autom.

2011>



← Lungh. Tot. = 605 mm →
Cave 27 Cave 34

LATO SX

FO 01009

RIFERIMENTI ORIGINALI



← Lungh. Tot. = 1006 mm →
Cave 34 Cave 27

FO 01010

LATO DX

NOTE

Focus I

1.4 16V 55Kw
1.6 16V 74Kw1998> | 1.8 16V 85Kw
1998>

1998>



← Lungh. Tot. = 635 mm →
Cave 25 Cave 23

LATO SX

FO 00113

RIFERIMENTI ORIGINALI

3667428

3667429

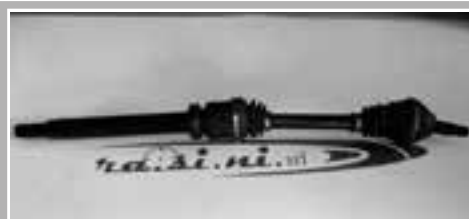

← Lungh. Tot. = 930 mm →
Cave 23 Cave 25

FO 00114

LATO DX

NOTE

Focus I

1.8 D-TD 55/66Kw
2.0 16v-TD 96Kw1998> |
1998>

← Lungh. Tot. = 615 mm →
Cave 25 Cave 26

LATO SX

FO 00111

RIFERIMENTI ORIGINALI

3652047

1141768
3651045

Fusello L/C 390mm

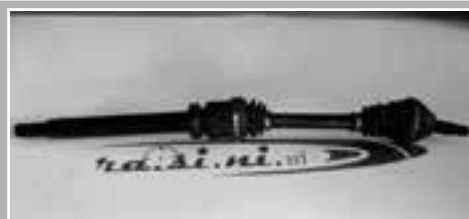

← Lungh. Tot. = 945 mm →
Cave 26 Cave 25

FO 00112

LATO DX

NOTE

Focus I

1.8 TDCI 85Kw
1.8 TDCI 74Kw2001> |
2002>

← Lungh. Tot. = 610 mm →
Cave 25 Cave 26

LATO SX

FO 00194

RIFERIMENTI ORIGINALI

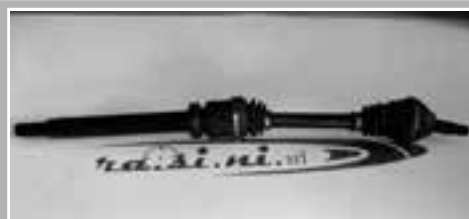
1328500
41872681328490
4166907

← Lungh. Tot. = 942 mm →
Cave 26 Cave 25

FO 00195

LATO DX

NOTE

Focus II - C-Max Focus 1.4 59Kw Focus 1.6 74/85Kw	2004>	C-Max 1.6 74/85Kw	2003>
	2004>		
	RIFERIMENTI ORIGINALI 1420578 1446235 9M51-3B437-BA 3M51-3B437-BAX 3M51B437BAX		
← Lungh. Tot. = 600 mm → Cave 36 Cave 23			← Lungh. Tot. = 905 mm → Cave 23 Cave 36
LATO SX FO 00149			FO 00150 LATO DX
NOTE Fonico Ø 56			

Focus II - C-Max Focus 1.6 TDCI 66/80kw C-Max 1.6 74/85Kw	2004>	C-Max 1.6 TDCI 66/80Kw	2.0 TDCI 81/98/100Kw	2007>
	2003>	C-Max 1.8 TDCI		
	RIFERIMENTI ORIGINALI 1364029 1454214 5M51-3B437-SD			
← Lungh. Tot. = 585 mm → Cave 36 Cave 26	Fusello L/C 380mm		← Lungh. Tot. = 920 mm → Cave 26 Cave 36	
LATO SX FO 00143			FO 00144 LATO DX	
NOTE				

Focus II - C-Max 2.0 TDCI 100Kw 2.0 LPG	2008>		
	RIFERIMENTI ORIGINALI 1437541 1456975 1474893 3M51-3B437-AAF		
← Lungh. Tot. = 585 mm → Cave 36 Cave 26	Fusello L/C 390mm		← Lungh. Tot. = 925 mm → Cave 26 Cave 36
LATO SX FO 00160			FO 00161 LATO DX
NOTE Fonico Ø 56			

Focus III 2.0 TDCI C/A 85/103/120Kw	2010>		
	RIFERIMENTI ORIGINALI AV613B437EB AV613B437EC AV613B437ED 1682460 1746980 1776427		
← Lungh. Tot. = 631 mm → Cave 27 Cave 28	Fusello L/C 371mm		← Lungh. Tot. = 975 mm → Cave 28 Cave 27
LATO SX FO 01015			FO 01016 LATO DX
NOTE			

Focus III - C-Max

2.0 TDCI 85/100/105/120Kw2011>



← Cave 27 →

LATO SX

FO 00167

RIFERIMENTI ORIGINALI

AV61-3B437-DB
1682459AV61-3B436-DC
1692121
1712269

← →

FO 00168

LATO DX

NOTE

Focus III - C-Max

Focus 1.6 88/92Kw
C-Max 1.6 88/92Kw2011>
2011>← Lungh. Tot. = 657 mm →
Cave 27 Cave 23

LATO SX

FO 00170

RIFERIMENTI ORIGINALI

AV61-3B437-AC

AV61-3B436-AD

← Lungh. Tot. = 962 mm →
Cave 23 Cave 27

FO 00171

LATO DX

NOTE Fonico Ø 56

Focus III - C-Max

1.6 TDCI 70/85Kw

2011>

← Lungh. Tot. = 640 mm →
Cave 27 Cave 26

LATO SX

FO 00198

RIFERIMENTI ORIGINALI

AV61-3B437-CB
AV61-3B437-DB
AV61-3B437-TA

AV61-3B436-CC

Fusello L/C 383mm

← Lungh. Tot. = 970 mm →
Cave 26 Cave 27

FO 00199

LATO DX

NOTE Fonico Ø 63

Focus C-Max

2.0 TDCI C/A 85/103/120Kw 2010>

← Lungh. Tot. = 631 mm →
Cave 27 Cave 28

LATO SX

FO 01015

RIFERIMENTI ORIGINALI

AV613B437EB
AV613B437EC
AV613B437ED
1682460
1746980
1776427AV613B436EB
AV613B436EC
AV613B436ED
AV613B436EE
1682458
1692122
1712270

Fusello L/C 371mm

← Lungh. Tot. = 975 mm →
Cave 28 Cave 27



FO 01016

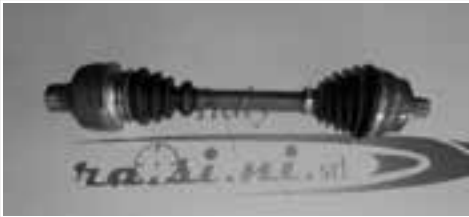

LATO DX

NOTE

Galaxy	1.9 TDI 66/81Kw 2.0 85Kw	96>00 2.3 107Kw 1995> 2.8 V6 128Kw	1995> 95>00
	RIFERIMENTI ORIGINALI		
	7M0407271J	7M0407272E	
← Lungh. Tot. = 620 mm → Cave 38 Cave 26			← Lungh. Tot. = 560 mm → Cave Int. 35 Cave 38
LATO SX	FO 00126		FO 00127 LATO DX
NOTE ABS 48D			

Galaxy	1.9 TDI 85/96Kw 2.8 V6 150Kw	00>06 00>06	
	RIFERIMENTI ORIGINALI		
	7M3407271P		
← Lungh. Tot. = 505 mm → Cave 38 Fori Ø10 Int. fori 104			← Lungh. Tot. = 505 mm → Fori Ø10 Int. fori 104 Cave 38
LATO SX	FO 00125		FO 00125 LATO DX
NOTE ABS 48			

Galaxy	1.8 TDCI 74/92Kw 2.0 74/92/107Kw	2006> 2.0 TDCI 96/103Kw 2006>	2006>
	RIFERIMENTI ORIGINALI		
	6G91-3B437-BD	6G91-3B436-FC	
← Lungh. Tot. = 607 mm → Cave 40 Cave 26		Fusello L/C 390mm	← Lungh. Tot. = 945 mm → Cave 26 Cave 40
LATO SX	FO 00162		FO 00163 LATO DX
NOTE			

Galaxy	2.0 TDCI C/A 96/100/103/120Kw	2006>2015	
	RIFERIMENTI ORIGINALI		
	8G91-3B437-AC 1726452	8G91-3B436-AD 1726342	
← Lungh. Tot. = 600 mm → Cave 40 Cave 28		Fusello L/C 430mm Parap. Ø 34	← Lungh. Tot. = 940 mm → Cave 28 Cave 40
LATO SX	FO 01012		FO 01013 LATO DX
NOTE			

Ka

1.3 l
1-6 70Kw1996>
2003>← Lungh. Tot. = 590 mm →
Cave 25 Cave 23

LATO SX

FO 00115

RIFERIMENTI ORIGINALI

1059534
R94FX3220BA

1059533

← Lungh. Tot. = 865 mm →
Cave 23 Cave 25

FO 00116

LATO DX

NOTE

Ka

1.3 TDCI 55Kw

2009>

← Lungh. Tot. = 617 mm →
Cave 25 Cave 22

LATO SX

FO 00147

RIFERIMENTI ORIGINALI

1541822
51787864
51955482
9S51-3B437-BA1541814
51787862
51955477
9S51-3B436-BA← Lungh. Tot. = 850 mm →
Cave 22 Cave 25

FO 00148

LATO DX

NOTE

Kuga

2.0 TDCI 100/103/120Kw 2008>
2.0 TDCI 4x4 100/103/120Kw 2008>← Lungh. Tot. = 650 mm →
Cave 27 Cave 26

LATO SX

FO 00153

RIFERIMENTI ORIGINALI

1594946
8V41-3B437-AC1594943
1683585
BV41-3B436-AC
8V41-3B436-BD

Fusello L/C 390mm

← Lungh. Tot. = 982 mm →
Cave 26 Cave 27

FO 00154

LATO DX

NOTE Fonico Ø 63

Kuga

2.0 TDCI 100/103Kw
2.0 TDCI 4x4 100/103/120Kw 12>← Lungh. Tot. = 650 mm →
Cave 27 Cave 31

LATO SX

FO 00174

RIFERIMENTI ORIGINALI

AV4N-3B437-AA



AV4N-3V436-AB

← Lungh. Tot. = 985 mm →
Cave 28 Cave 27



FO 00175

LATO DX



NOTE

Mondeo	1.6 I 16V 65/66Kw 1.8 I 16V 85Kw	93>00 2.0 I 16V 96/100Kw 93>00	93>00
	RIFERIMENTI ORIGINALI		
← Lungh. Tot. = 620 mm → Cave 27 Cave 26	5029040* 5029043 7024791* 7024792	5029036* 5029038 7024789* 7024790	← Lungh. Tot. = 570 mm → Cave Int. 34 Cave 27
LATO SX FO 00117 - FO 00117/A*	A = ABS 44	A = ABS 44	FO 00118 - FO 00118/A* LATO DX



NOTE ABS 44D su richiesta

Mondeo	1.8 TD 65Kw 2.5 I V6 24v 125Kw	>2000 >2000	
	RIFERIMENTI ORIGINALI		
← Lungh. Tot. = 620 mm → Cave 27 Cave 26	6757668 6757672* 6757676	6757666* 6757676 6757678	← Lungh. Tot. = 570 mm → Cave Int. 34 Cave 27
LATO SX FO 00119 - FO 00119/A*	A = ABS 44	A = ABS 44	FO 00120 - FO 00120/A* LATO DX



NOTE ABS 44D su richiesta



Mondeo	2.2 TDCI 129/147Kw 03/08>03/14		
	RIFERIMENTI ORIGINALI		
← Lungh. Tot. = 590 mm → Cave 40 Cave 31		Fusello L/C 415mm Par. Ø 39,50	← Lungh. Tot. = 960 mm → Cave 31 Cave 40
LATO SX FO 01001			FO 01002 LATO DX



NOTE

Mondeo	1.8 16v 81/92Kw 2.0 TDCI 66/85/96Kw	2000> 2000>	2.0 16v 107Kw 2.2 TDCI 114Kw	2004> 2.5 V6 125Kw 2000>
	RIFERIMENTI ORIGINALI			
← Lungh. Tot. = 630 mm → Cave 27 Cave 26	1326261	1326262	← Lungh. Tot. = 580 mm → Cave 34 Cave 27	
LATO SX FO 00141			FO 00142 LATO DX	



NOTE Fonico Ø 56

Mondeo	1.8 TDCI 74Kw 2.0 TDCI 103Kw	2007> 2007>		
	RIFERIMENTI ORIGINALI 6G91-3B437-BD	6G91-3B436-FC		
← Lungh. Tot. = 607 mm → Cave 40 Cave 26		Fusello L/C 390mm	← Lungh. Tot. = 945 mm → Cave 26 Cave 40	
LATO SX	FO 00162		FO 00163	LATO DX
NOTE				

Mondeo	2.0 TDCI C/A 96/103/120Kw			
	RIFERIMENTI ORIGINALI 8G91-3B437-AC 1726452	8G91-3B436-AD 1726342		
← Lungh. Tot. = 595 mm → Cave 40 Cave 28		Fusello L/C 430mm Parap. Ø 34	← Lungh. Tot. = 950 mm → Cave 28 Cave 40	
LATO SX	FO 01012		FO 01013	LATO DX
NOTE				

Puma	1.4 16v 66Kw 1.7 16v 92Kw	98>00 1997>		
	RIFERIMENTI ORIGINALI 1059524	RE97FX3219F1A		
← Lungh. Tot. = 600 mm → Cave 25 Cave 23			← Lungh. Tot. = 900 mm → Cave 25 Cave 23	
LATO SX	FO 00107		FO 00128	LATO DX
NOTE Fonico Ø 56				



S-Max	2.0 TDCI C/A 96/103/120Kw			
	RIFERIMENTI ORIGINALI 8G91-3B437-AC 1726452	8G91-3B436-AD 1726342		
← Lungh. Tot. = 600 mm → Cave 40 Cave 28		Fusello L/C 430mm Parap. Ø 34	← Lungh. Tot. = 940 mm → Cave 28 Cave 40	
LATO SX	FO 01012		FO 01013	LATO DX
NOTE				

S-Max		2.0 TDCI 103Kw	2006>	
 <p>← Lungh. Tot. = 607 mm → Cave 40 Cave 26</p> <p>LATO SX FO 00162</p>	RIFERIMENTI ORIGINALI		 <p>← Lungh. Tot. = 945 mm → Cave 26 Cave 40</p> <p>FO 00163 LATO DX</p>	
	6G91-3B437-BD	6G91-3B436-FC		Fusello L/C 390mm

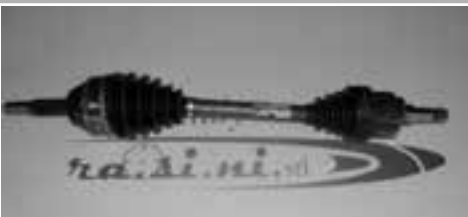

NOTE

S-Max		2.0 TDCI C. Aut.		
 <p>← Lungh. Tot. = 590 mm → Cave 40 Cave 31</p> <p>LATO SX FO 01001</p>	RIFERIMENTI ORIGINALI		 <p>← Lungh. Tot. = 960 mm → Cave 31 Cave 40</p> <p>FO 01002 LATO DX</p>	
				Fusello L/C 415mm Par. Ø 39,50



NOTE

Transit		Transit VII 2.0 DI 55/62/63Kw	00>06	
 <p>← Lungh. Tot. = 795 mm → Cave 28 Cave 26</p> <p>LATO SX FO 00145 - FO 00145/A</p>	RIFERIMENTI ORIGINALI		 <p>← Lungh. Tot. = 1055 mm → Cave 26 Cave 28</p> <p>FO 00146 - FO 00146/A* LATO DX</p>	
	1C153B437CF	6G913C083AA 1459756 1701597		Fusello L/C 328mm A = ABS 48 A = ABS 48

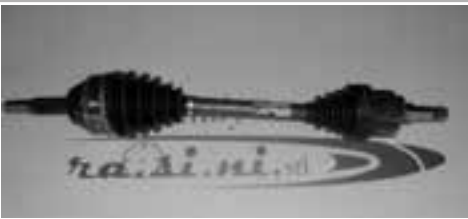

NOTE Fonico Ø 57

Transit		2.0 DI 74Kw	2000>	
 <p>← Lungh. Tot. = 796 mm → Cave 28 Cave 36</p> <p>LATO SX FO 00155 - FO 00155/A</p>	RIFERIMENTI ORIGINALI		 <p>← Lungh. Tot. = 1055 mm → Cave 36 Cave 28</p> <p>FO 00156 - FO 00156/A LATO DX</p>	
	1417762	4615961 1600221 1C153B436CH 1417Z47		Fusello L/C 328mm A = ABS 48 A = ABS 48

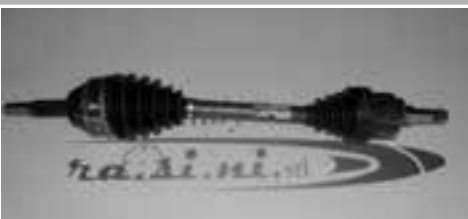

NOTE Fonico Ø 57

Transit	2.0 TDCi 92Kw 2.2 81/96Kw	2002> 06>14	
	RIFERIMENTI ORIGINALI 1C15-3B437-GG 3C11-3B437-BB 4602016 1495673 1495580	1C15-3B436-CG 1C15-3B436-CH 3C11-3B436-BB 1495672 1445100 6C113B436DD 6C113B436DE	
← Lungh. Tot. = 800 mm → Cave 28 Cave 36	Fusello L/C 327mm	← Lungh. Tot. = 1061 mm → Cave 36 Cave 28	
LATO SX FO 00157 - FO 00157/A		FO 00158 - FO 00158/A LATO DX	

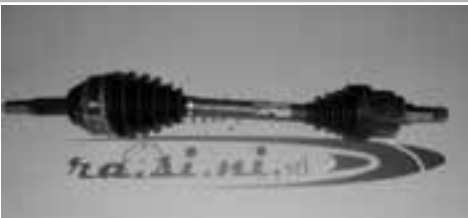

NOTE Fonico Ø 57

Transit	2.2 TDCi 85/103Kw 3.2 TDCi 147Kw	07>13	
	RIFERIMENTI ORIGINALI 152912 8C11-3B437-AD	152911 8C11-3B436-AD	
← Lungh. Tot. = 754 mm → Cave 28 Cave 41	Fusello L/C 405mm	← Lungh. Tot. = 1090 mm → Cave 41 Cave 28	
LATO SX FO 01003		FO 01004 LATO DX	

NOTE Fonico Ø 61



Transit	2.2 TDCi 74Kw	2013>	
	RIFERIMENTI ORIGINALI 1774279 BK21-3B437-AB	1774275 BK21-3B436-AB	
← Lungh. Tot. = 755 mm → Cave 31 Cave 41	Fusello L/C 405mm	← Lungh. Tot. = 1090 mm → Cave 41 Cave 31	
LATO SX FO 01005		FO 01006 LATO DX	

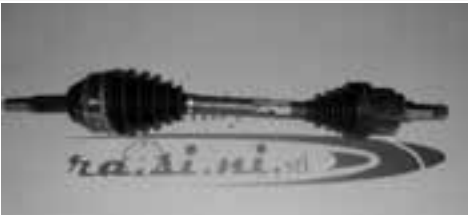
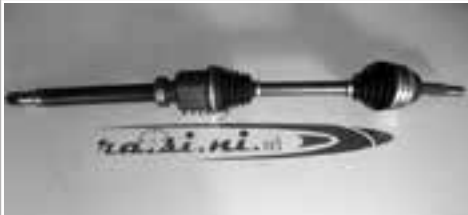

NOTE Fonico Ø 57,6

Transit	2.2 TDCi 92/114Kw	2013>	
	RIFERIMENTI ORIGINALI 1774281 BK21-3B437-BB	1774277 BK21-3B436-BB	
← Lungh. Tot. = 755 mm → Cave 31 Cave 41	Fusello L/C 405mm	← Lungh. Tot. = 1090 mm → Cave 41 Cave 31	
LATO SX FO 01007		FO 01008 LATO DX	

NOTE Fonico Ø 57,6



Transit		22 TDCI 74/92 22 TDCI 4x4	2011>2014	
 <p>← Lungh. Tot. = 764 mm → Cave 28 Cave 41</p> <p>LATO SX FO 01109</p>	RIFERIMENTI ORIGINALI		 <p>← Lungh. Tot. = 1101 mm → Cave 28 Cave 41</p> <p>LATO DX FO 01110</p>	
	1793822 1727122 1512912	1727121 1793821		
NOTE ABS 48D Ø 104				



Transit Connect		1.8 DI 55Kw	2002>	
 <p>← Lungh. Tot. = 627 mm → Cave 25 Cave 26</p> <p>LATO SX FO 00151</p>	RIFERIMENTI ORIGINALI		 <p>← Lungh. Tot. = 963 mm → Cave 26 Cave 25</p> <p>LATO DX FO 00152</p>	
	1417751 2T14-3B437-CD 2T14-3B437-CE 9T16-3B437-AA	1501261 2T14-3B436-CA 2T14-3B436-CC 2T14-3B436-CF		
NOTE Fonico Ø 53,2				

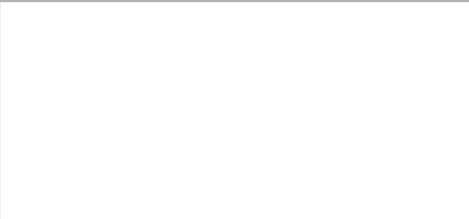

Transit Connect		1.8 TDCI 66Kw	2002>	
 <p>← Lungh. Tot. = 630 mm → Cave 25 Cave 26</p> <p>LATO SX FO 00196</p>	RIFERIMENTI ORIGINALI		 <p>← Lungh. Tot. = 960 mm → Cave 26 Cave 25</p> <p>LATO DX FO 00197</p>	
	1451466 4490558 5083616 2T14-3B437-FA 2T14-3B437-FB 2T14-3B437-FC 2T14-3B437-FD	1328362 2T14-3B436-AE 2T14-3B436-FE		
NOTE				

 <p>← →</p> <p>LATO SX</p>	RIFERIMENTI ORIGINALI		 <p>← →</p> <p>LATO DX</p>	
NOTE				

Accord VI	1.8 100Kw 2.3 110/113Kw	98>02 98>02		
 <p>← Lungh. Tot. = 586 mm → Cave 28 Cave 27</p> <p>LATO SX HO 00121</p>	RIFERIMENTI ORIGINALI		 <p>← Lungh. Tot. = 621 mm → Cave 27 Cave 28</p> <p>HO 00122 LATO DX</p>	
	4430651AE01	4430551AE01		
NOTE ABS 50				

Civic	1.3 16v 55Kw 1.4 16v 66Kw	87>91 87>91	1.5 16v 69Kw 1.6 16v 80Kw	87>91 87>91
 <p>← Lungh. Tot. = 905 mm → Cave 26 Cave 25</p> <p>LATO SX HO 00109</p>	RIFERIMENTI ORIGINALI		 <p>← Lungh. Tot. = 605 mm → Cave 25 Cave 26</p> <p>HO 00110 LATO DX</p>	
	44306SH3A01 44306SH3960	44305SH3A01 44305SH3960		
NOTE				

Civic	1.3 16v 55Kw 1.5 I 16v 66Kw	91>95 91>95	1.6 16v 69Kw 1.6 VTI 92Kw	91>95 91>95
 <p>← Lungh. Tot. = 905 mm → Cave 26 Cave 25</p> <p>LATO SX HO 00111 - HO 00111/A</p>	RIFERIMENTI ORIGINALI		 <p>← Lungh. Tot. = 620 mm → Cave 25 Cave 26</p> <p>HO 00112 - HO 00112/A LATO DX</p>	
	44011SR3020	44010SR3020		
NOTE A = ABS 50				



Civic	2.2 CTDI 103Kw	2006>		
 <p>← Lungh. Tot. = 550 mm → Cave 28 Cave 27</p> <p>LATO SX HO 00119</p>	RIFERIMENTI ORIGINALI		 <p>← Lungh. Tot. = 616 mm → Cave 29 Cave 28</p> <p>HO 00120 LATO DX</p>	
	44306SMJG01	44305SMJG01		
NOTE ABS 50D				



Civic	1.6 91Kw	89>92		
	RIFERIMENTI ORIGINALI			
← Lungh. Tot. = 570 mm Cave 26				→ Lungh. Tot. = 570 mm Cave 27
LATO SX	HO 00113 - HO 00113/A	Fusello L/C tutto incavato		HO 00124 - HO 00124/A LATO DX
NOTE A = ABS 50				



Civic	1.6 16v 1.6 16v VTEC 110Kw	1992> 1992>		
	RIFERIMENTI ORIGINALI			
← Lungh. Tot. = 560 mm Cave 26				→ Lungh. Tot. = 595 mm Cave 27
LATO SX	HO 00115 - HO 00115/A			HO 00126 - HO 00126/A LATO DX
NOTE A = ABS 50				



Civic	1.7 CTDI 74Kw	02>05		
	RIFERIMENTI ORIGINALI			
← Lungh. Tot. = 605 mm Cave 26	44306S6FE51	44305S6FE51		→ Lungh. Tot. = Cave 29
LATO SX	HO 00117			HO 00118 LATO DX
NOTE ABS 50				



Civic	1.6 I 4WD	92>95		
	RIFERIMENTI ORIGINALI			
← Lungh. Tot. = 605 mm Cave 26				→ Lungh. Tot. = 605 mm Cave 27
LATO SX	RO 00119	Fusello L/C tutto incavato		RO 00120 LATO DX
NOTE				



Concerto	1.5 l 16v 1.6 16v	89>95 89>95		
	RIFERIMENTI ORIGINALI			
← Lungh. Tot. = 607 mm → Cave 26 Cave 25	A = ABS 50	A = ABS 50	← Lungh. Tot. = 910 mm → Cave 25 Cave 26	
LATO SX HO 00101 - HO 00101/A			HO 00102 - HO 00102/A	LATO DX
NOTE ABS 50D su richiesta				



Concerto	1.4 66Kw 1.6 l DOHC 16v	90>93 89>95	1.6 82Kw 90>93	
	RIFERIMENTI ORIGINALI			
← Lungh. Tot. = 605 mm → Cave 26 Cave 27	Fusello L/C tutto incavato A= ABS 50	A= ABS 50	← Lungh. Tot. = 605 mm → Cave 27 Cave 26	
LATO SX RO 00119 - RO 00119/A			RO 00120 - RO 00120/A	LATO DX
NOTE ABS 50D su richiesta				



Concerto	1.8 TD	94>95		
	RIFERIMENTI ORIGINALI			
← Lungh. Tot. = → Cave 26 Cave 29			← Lungh. Tot. = → Cave 29 Cave 26	
LATO SX HO 00105			HO 00106	LATO DX
NOTE				

Jazz	1.2 33/40/41Kw	84>86		
	RIFERIMENTI ORIGINALI			
← Lungh. Tot. = 845 mm → Cave 23 Cave 25			← Lungh. Tot. = 591 mm → Cave 25 Cave 23	
LATO SX HO 00107			HO 00108	LATO DX
NOTE				

Accent		1.3 44Kw 1.5 65Kw	94>00 94>00	
 <p>Lungh. Tot. = 610 mm Cave 25 Cave 25</p> <p>LATO SX HU 00107</p>	RIFERIMENTI ORIGINALI		 <p>Lungh. Tot. = 908 mm Cave 25 Cave 25</p> <p>HU 00108 LATO DX</p>	
NOTE				

Atos		1.0 40Kw	1998>	
 <p>Lungh. Tot. = 600 mm Cave 25 Cave 22</p> <p>LATO SX HU 00101 - HU 00101/A</p>	RIFERIMENTI ORIGINALI		 <p>Lungh. Tot. = 810 mm Cave 22 Cave 25</p> <p>HU 00102 - HU 00102/A LATO DX</p>	
	49507-02A00 49507-02A10	49508-02A00 49508-02A10		A = ABS 38
NOTE ABS 38				

Atos Prime		1-1 43/46Kw		
 <p>Lungh. Tot. = 590 mm Cave 25 Cave 22</p> <p>LATO SX HU 00133</p>	RIFERIMENTI ORIGINALI		 <p>Lungh. Tot. = Cave 22 Cave 25</p> <p>HU 00134 LATO DX</p>	
	49500-05100	49500-05110		
NOTE ABS 38				

Coupé		1.6 84/85Kw	98>02	
 <p>Lungh. Tot. = 647 mm Cave 25 Cave 25</p> <p>LATO SX HU 00115 - HU 00115/A</p>	RIFERIMENTI ORIGINALI		 <p>Lungh. Tot. = 920 mm Cave 25 Cave 25</p> <p>HU 00116 - HU 00116/A LATO DX</p>	
	49501-2D412	49500-2D412 49508-29A00		A = ABS 29
NOTE ABS 29D su richiesta				

Getz

1.1 46/49Kw
1.3 60/63Kw02>05
02>05

← Lungh. Tot. = 620 mm →
Cave 25 Cave 25

LATO SX

HU 00109

RIFERIMENTI ORIGINALI

49500-1C050

49500-1C060



← Lungh. Tot. = 910 mm →
Cave 25 Cave 25

HU 00110

LATO DX

NOTE ABS 48D

Getz

1.5 CRDI 60/65Kw

2003>



← Lungh. Tot. = 630 mm →
Cave 25 Cave 25

LATO SX

HU 00113

RIFERIMENTI ORIGINALI

495001C550
495001C460

495001C560



← Lungh. Tot. = 580 mm →
Cave interne 26 Cave 25

HU 00114

LATO DX

NOTE ABS 48D

i10

1.1 51Kw

2008>



← Lungh. Tot. = 630 mm →
Cave 24 Cave 25

LATO SX

HU 00121

RIFERIMENTI ORIGINALI

495000X100
495000X300
495000X400495000X110
495000X310
495000X410

← Lungh. Tot. = 845 mm →
Cave 25 Cave 24

HU 00122

LATO DX

NOTE ABS 48D

i20

1.6 CRDI 85Kw

2008>



← Lungh. Tot. = →
Cave 25 Cave 27

LATO SX

HU 00150

RIFERIMENTI ORIGINALI







← Lungh. Tot. = 940 mm →
Cave 27 Cave 25



HU 00151



LATO DX

NOTE ABS 48

i 20	1.4 CRDI 55/66Kw	2008>		
 <p>Lungh. Tot. = 645 mm Cave 25 Cave 27</p> <p>LATO SX HU 00157</p>	RIFERIMENTI ORIGINALI		 <p>Lungh. Tot. = 645 mm Cave 27 Cave 25</p> <p>HU 00158 LATO DX</p>	
	49526-1J401	49525-1J401		
NOTE ABS 48				

i 30	1.6 CRDI 66/85Kw	07>11		
 <p>Lungh. Tot. = 672 mm Cave 27 Cave 27</p> <p>LATO SX HU 00155</p>	RIFERIMENTI ORIGINALI		 <p>Lungh. Tot. = 950 mm Cave 27 Cave 27</p> <p>HU 00156 LATO DX</p>	
	495012L210	495002L410		
NOTE ABS 46 Ø 82				

IX 20	1.4 CRDI 57/66Kw 1.6 CRDI 86Kw	2011> 2011>		
 <p>Lungh. Tot. = 680 mm Cave 27 Cave 27</p> <p>LATO SX HU 00159</p>	RIFERIMENTI ORIGINALI		 <p>Lungh. Tot. = 960 mm Cave 27 Cave 27</p> <p>HU 00160 LATO DX</p>	
	495001P2000	495011P2000		
NOTE ABS 46				

IX 35	2.0 CRDI 155Kw	2010>		
 <p>Lungh. Tot. = 662 mm Cave 30 Cave 28</p> <p>LATO SX HU 00152</p>	RIFERIMENTI ORIGINALI		 <p>Lungh. Tot. = 610 mm Cave int 28 Cave 30</p> <p>HU 00153 LATO DX</p>	
	49500-2B320 49500-2B360 49500-2B750 49500-2P100 49500-2B260	49500-2B610 49501-2B700 49501-2P000		
NOTE ABS 52				

IX 35

2.0 CRDI 100Kw

2010>



← Lungh. Tot. = 690 mm →
Cave 30 Cave 27

LATO SX

KI 00129

RIFERIMENTI ORIGINALI

495012Y900
495002Y900
495002Y100



← Lungh. Tot. = 980 mm →
Cave 27 Cave 30

KI 00131

LATO DX

NOTE

IX 35

2.0 CRDI 4WD 100Kw
2.0.4 WD 120Kw2010>
2010>

← Lungh. Tot. = 690 mm →
Cave 30 Cave 27

LATO SX

KI 00129

RIFERIMENTI ORIGINALI

495012Y900
49502Y900
49502Y100

495012Y050



← Lungh. Tot. = 585 mm →
Cave Int 28 Cave 30

KI 00130

LATO DX

NOTE ABS 48

Lantra II

1.5 65Kw

96>00



← Lungh. Tot. = 630 mm →
Cave 25 Cave 25

LATO SX

HU 00111

RIFERIMENTI ORIGINALI



← Lungh. Tot. = 935 mm →
Cave 25 Cave 25

HU 00112

LATO DX

NOTE

Matrix

1.5 CRDI 60/75Kw

01>10



← Lungh. Tot. = 657 mm →
Cave 25 Cave 25

LATO SX

HU 00117

RIFERIMENTI ORIGINALI

4950017150

4950117150







← Lungh. Tot. = 585 mm →
Cave Int. 24 Cave 25

HU 00118



LATO DX

NOTE ABS 44 Ø 82

Matrix	1.6 76Kw	01>10		
	RIFERIMENTI ORIGINALI			
	49500-17050	40501-17050		
← Lungh. Tot. = 639 mm → Cave 25 Cave 25			← Lungh. Tot. = 920 mm → Cave 25 Cave 25	
LATO SX	HU 00130		HU 00131	LATO DX
NOTE ABS 44				

Matrix	1.5 CRDI 81Kw	01>10		
	RIFERIMENTI ORIGINALI			
	49500-17510			
← Lungh. Tot. = 650 mm → Cave 25 Cave 27			← Lungh. Tot. = 585 mm → Cave int. 26 Cave 25	
LATO SX	HU 00135		HU 00136	LATO DX
NOTE ABS 44				

Matrix	1.6 76Kw	01>10		
	RIFERIMENTI ORIGINALI			
← Lungh. Tot. = 640 mm → Cave 25 Cave 25			← Lungh. Tot. = 940 mm → Cave 25 Cave 25	
LATO SX	HU 00140		HU 00141	LATO DX
NOTE ABS 44				

Pony	1.3 50Kw 1.5 53Kw	85>87 85>90		
	RIFERIMENTI ORIGINALI			
← Lungh. Tot. = 900 mm → Cave 25 Cave 25			← Lungh. Tot. = 587 mm → Cave 25 Cave 25	
LATO SX	HU 00103		HU 00104	LATO DX
NOTE				

Santa Fe

2.2 CRDi 102/110/114/145Kw
2006>2012← Lungh. Tot. = 662 mm →
Cave 30 Cave 28

LATO SX

HU 00152

RIFERIMENTI ORIGINALI

49500-2B320
49500-2B360
49500-2B750
49500-2P100
49500-2B26049500-2B610
49501-2B700
49501-2P000← Lungh. Tot. = 610 mm →
Cave int 28 Cave 30

HU 00153

LATO DX

NOTE ABS 52

Santa Fe

2.0 CRDi 4x4 83/92Kw 01>06 | 2.7 V6 127Kw
2.4 100/107Kw← Lungh. Tot. = 660 mm →
Cave 27 Cave 27

LATO SX

HU 00123

RIFERIMENTI ORIGINALI

49501-26411

49562-26200

← Lungh. Tot. = 610 mm →
Cave int. 26 Cave 27

HU 00124

LATO DX

NOTE ABS 52

Santa Fe

2.0 CRDI 2012>

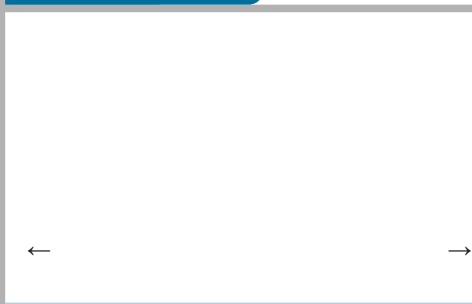

LATO SX

HU 00170

RIFERIMENTI ORIGINALI

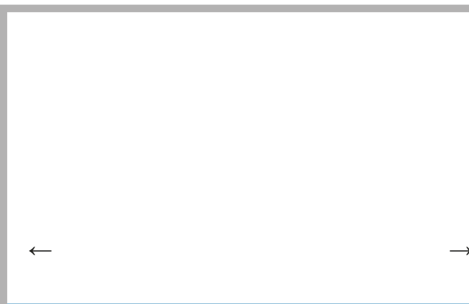

HU 00171

LATO DX

NOTE

Sonata

1.8 70Kw
2.0 74Kw89>91 | 2.4 82/90Kw
89>91

89>91

← Lungh. Tot. = 615 mm →
Cave 25 Cave 25

LATO SX

HU 00105



RIFERIMENTI ORIGINALI



← Lungh. Tot. = 965 mm →
Cave 25 Cave 25

HU 00106

LATO DX

NOTE

Trajt		2.0 D 100Kw	2000>	
 <p>Lungh. Tot. = 664 mm Cave 27 Cave 27</p>	RIFERIMENTI ORIGINALI		 <p>Lungh. Tot. = 622 mm Cave Int. 24 Cave 27</p>	
	49500-3A217	49500-38900 49501-3A392		
LATO SX	HU 00119			HU 00120 LATO DX
NOTE ABS 47D				

Tucson		2.0 CRDI 104Kw 2.7 129Kw	04>10 04>10	
 <p>Lungh. Tot. = 670 mm Cave 27 Cave 27</p>	RIFERIMENTI ORIGINALI		 <p>Lungh. Tot. = 610 mm Cave int. 24 Cave 27</p>	
	49501-2E500	49500-2E550		
LATO SX	HU 00148			HU 00149 LATO DX
NOTE				

 <p>Lungh. Tot. =</p>	RIFERIMENTI ORIGINALI		 <p>Lungh. Tot. =</p>	
LATO SX				LATO DX
NOTE				

 <p>Lungh. Tot. =</p>	RIFERIMENTI ORIGINALI		 <p>Lungh. Tot. =</p>	
LATO SX				LATO DX
NOTE				

Mini 2 Cil.

1.0 27/32Kw

1983>



← Lungh. Tot. = 552 mm →
Cave 20 Cave 23

LATO SX

IN 00101

RIFERIMENTI ORIGINALI

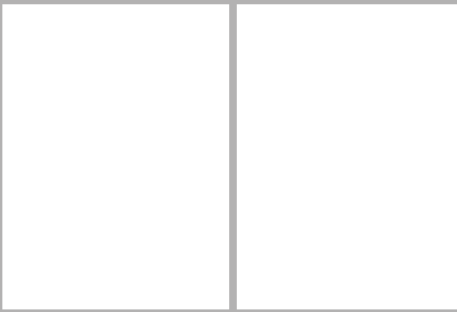

← Lungh. Tot. = 772 mm →
Cave 23 Cave 20

IN 00102

LATO DX

NOTE

Mini 3 Cil.

650 24Kw

1985>



← Lungh. Tot. = 627 mm →
Cave 20 Cave 21

LATO SX

IN 00105

RIFERIMENTI ORIGINALI



← Lungh. Tot. = 682 mm →
Cave 21 Cave 20

IN 00106

LATO DX

NOTE

RIFERIMENTI ORIGINALI

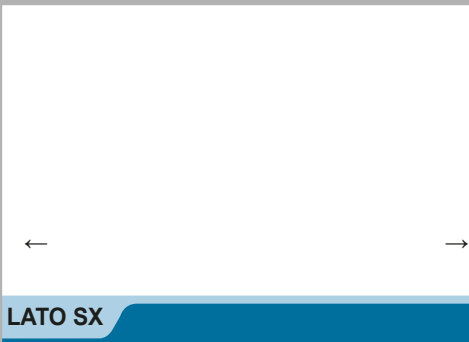

← →

LATO SX



← →

LATO DX

NOTE

RIFERIMENTI ORIGINALI

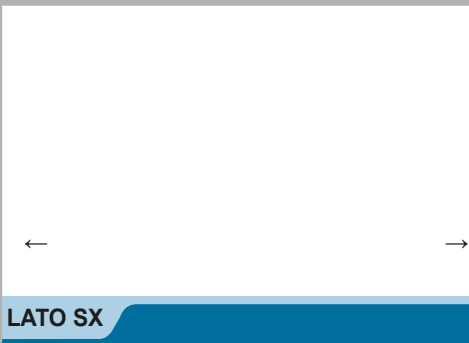

← →



LATO SX



← →

LATO DX

NOTE

X-Type		2.0 D 96Kw	03>05	
 <p>← Lungh. Tot. = 635 mm → Cave 27 Cave 26</p>	RIFERIMENTI ORIGINALI		 <p>← Lungh. Tot. = 955 mm → Cave 26 Cave 27</p>	
	C2S29732 C2S40435	C2S29370 C2S40434		
LATO SX	JA 00101		JA 00102	LATO DX

NOTE

	RIFERIMENTI ORIGINALI		
←			→
LATO SX			LATO DX

NOTE

	RIFERIMENTI ORIGINALI		
←			→
LATO SX			LATO DX



NOTE



	RIFERIMENTI ORIGINALI		
←			→
LATO SX			LATO DX

NOTE

Cherokee		2.5 TD 85Kw 2.5 I 87/90Kw	1995> 4.0 I 130Kw 93>01	93>01
RIFERIMENTI ORIGINALI				
← Lungh. Tot. = 578 mm → Cave 27 Cave		A = ABS 54	A = ABS 54	← Lungh. Tot. = 973 mm → Cave Cave 27
LATO SX JP 00101 - JP 00101/A				JP 00102 - JP 00102/A LATO DX
NOTE ABS 54D su richiesta				

Gran Cherokee		2.5 TD 85Kw 4.0 I 130Kw	1996> 1996>	
RIFERIMENTI ORIGINALI				
← Lungh. Tot. = 578 mm → Cave 27 Cave		A = ABS 54	A = ABS 54	← Lungh. Tot. = 973 mm → Cave Cave 27
LATO SX JP 00101 - JP 00101/A				JP 00102 - JP 00102/A LATO DX
NOTE ABS 54D su richiesta				

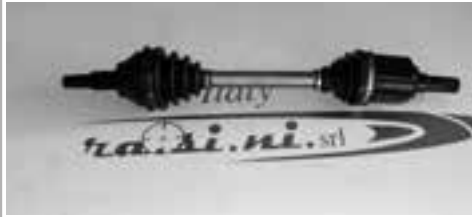
Renegade		1.4 103Kw C/A	2014>	
RIFERIMENTI ORIGINALI				
 ← Lungh. Tot. = 632 mm → Cave 27 Cave 25		52010998 PAR Ø 32	52010996 PAR Ø 30 L/C 433	 ← Lungh. Tot. = 980 mm → Cave 25 Cave 27
LATO SX JP 00105				JP 00106 LATO DX
NOTE				

Renegade		1.4 103Kw	2014>	
RIFERIMENTI ORIGINALI				
 ← Cave 27 Cave 25 →		51936052	51935911 PAR Ø 30 L/C 430	 ← Lungh. Tot. = 972 mm → Cave 25 Cave 27
LATO SX JP 00107				JP 00108 LATO DX
NOTE Cuscinetto cromato				

Renegade 1.4 103Kw Posteriori		RIFERIMENTI ORIGINALI	
← Lungh. Tot. = 582 mm → Cave 27 Cave int. 22		51939962	
← Lungh. Tot. = 582 mm → Cave int. 22 Cave 27			
LATO SX	JP 00111		JP 00111 LATO DX
NOTE			

Renegade 1.6 MJet 88Kw		2014	
RIFERIMENTI ORIGINALI			
← Cave 27 → Cave int. 25		51936050	51935909
← Cave 25 → Cave 27		L/C 424	
LATO SX	JP 00109		JP 00110 LATO DX
NOTE			

Wrangler 2.5 85Kw 4.0 130Kw		93>01 93>01	
RIFERIMENTI ORIGINALI			
← Lungh. Tot. = 578 mm → Cave 27 Cave		A = ABS 54	A = ABS 54
← Lungh. Tot. = 973 mm → Cave Cave 27			
LATO SX	JP 00101 - JP 00101/A		JP 00102 - JP 00102/A LATO DX
NOTE ABS 54D su richiesta			

RIFERIMENTI ORIGINALI		
← →		← →
LATO SX		LATO DX
NOTE		

Carens

1.6 Benzina



← Lungh. Tot. = 637 mm →
Cave 28 Cave 26

LATO SX

KI 00115

RIFERIMENTI ORIGINALI

← →

KI 00116

LATO DX

NOTE

Carens

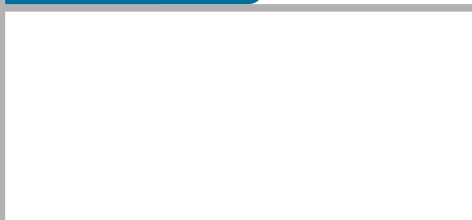
1.8 93Kw
2.0 CVVT 102Kw2002>
2004>

← Lungh. Tot. = 610 mm →
Cave 28 Cave 28

LATO SX

KI 00119

RIFERIMENTI ORIGINALI

1K2KB2560X

1K2KB2540X



← Lungh. Tot. = 627 mm →
Cave int. 28 Cave 28

KI 00120

LATO DX

NOTE

Carens

2.0 CRDi 103/140Kw
2.0 CRDi 100/133Kw2006>
2009>

← Lungh. Tot. = 630 mm →
Cave 28

LATO SX

KI 00121

RIFERIMENTI ORIGINALI

495011D700

405001D700



← Lungh. Tot. = 910 mm →
Cave 28

KI 00122

LATO DX

NOTE ABS 44

Carnival

2.9 TDI 93Kw
2.5 V6 121Kw99>01
99>01

← Lungh. Tot. = 650 mm →
Cave 28 Cave 28

LATO SX

KI 00101

RIFERIMENTI ORIGINALI

0K55222510A
0K55222620A

0K55225600A







← Lungh. Tot. = 600 mm →
Cave Int. 26 Cave 28



KI 00102

LATO DX



NOTE ABS 54D



Carnival 2.9 CRDI 106/136Kw C/A 2001>		
 <p>← Lungh. Tot. = 620 mm → Cave 28 Cave 28</p> <p>LATO SX KI 00103</p>	RIFERIMENTI ORIGINALI	
	0K5542560XA	0K5542550XA
		 <p>← Lungh. Tot. = 550 mm → Cave Int. 28 Cave 28</p> <p>KI 00104 LATO DX</p>
NOTE ABS 54D		

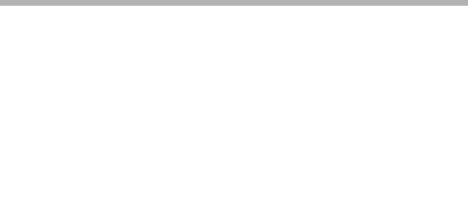
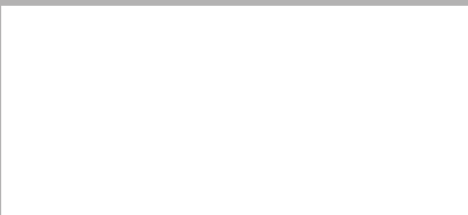

Cerato 1.5 CRDi 75Kw 2005>		
 <p>← Lungh. Tot. = 650 mm → Cave 27 Cave 25</p> <p>LATO SX KI 00125</p>	RIFERIMENTI ORIGINALI	
		 <p>← Lungh. Tot. = 930 mm → Cave 25 Cave 27</p> <p>KI 00126 LATO DX</p>
NOTE ABS 44		



Cerato 1.6 77/90Kw 2004>		
 <p>← Lungh. Tot. = 650 mm → Cave 25 Cave 25</p> <p>LATO SX KI 00123</p>	RIFERIMENTI ORIGINALI	
	49501-2F110	49500-2F110
		 <p>← Cave 25 → Cave 25</p> <p>KI 00124 LATO DX</p>
NOTE ABS 44		

Clarus 1.8 16v 85Kw 1998> 2.0 16v 98Kw 1998>		
 <p>← →</p> <p>LATO SX KI 00119</p>	RIFERIMENTI ORIGINALI	
		 <p>← →</p> <p>KI 00120 LATO DX</p>
NOTE		

Picanto	1.0 44/45Kw 1.1 48Kw	06>11 2004>	RIFERIMENTI ORIGINALI	
	4950007010	4950007060		
← Lungh. Tot. = 625 mm → Cave 24 Cave 25			← Lungh. Tot. = 850 mm → Cave 25 Cave 24	
LATO SX	KI 00105		KI 00106	LATO DX
NOTE ABS 48D				

Picanto	1.0 60Kw 1.2 63Kw	2011> 2012>	RIFERIMENTI ORIGINALI	
	495001Y000 495001Y010	495011Y010		
← Lungh. Tot. = 603 mm → Cave 24 Cave 25			← Lungh. Tot. = 894 mm → Cave 25 Cave 24	
LATO SX	KI 00117		KI 00118	LATO DX
NOTE				

Rio	1.3 55/60Kw 1.5 71/72Kw	00>05 00>05	RIFERIMENTI ORIGINALI	
	1K30A2560X	1K30A2540X		
← Lungh. Tot. = 605 mm → Cave 24 Cave 26			← Lungh. Tot. = 890 mm → Cve 26 Cave 24	
LATO SX	KI 00107		KI 00108	LATO DX
NOTE				

Rio	1.4 16v 71Kw	2005>	RIFERIMENTI ORIGINALI	
	495001G010	495001G050		
← Lungh. Tot. = →			← Lungh. Tot. = →	
LATO SX	KI 00109		KI 00110	LATO DX
NOTE AS 48D				



Rio	1.5 CRDI 81Kw	2005>		
	RIFERIMENTI ORIGINALI			
← Lungh. Tot. = 640 mm → Cave 25 Cave 25			← Lungh. Tot. = Cave 25 Cave 25	
LATO SX	KI 00113		KI 00114	LATO DX
NOTE				

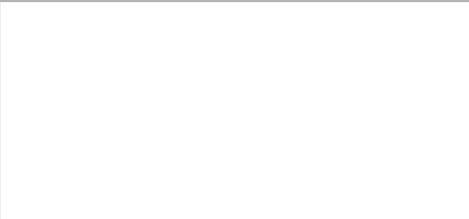

Sephia	1.5 1.6	1996> 1995>		
	RIFERIMENTI ORIGINALI			
← Lungh. Tot. = 635 mm → Cave 26 Cave 24			← Lungh. Tot. = 895 mm → Cave 26 Cave 24	
LATO SX	KI 00111		KI 00112	LATO DX
NOTE				

Sorento	2.2 CRDi 102/110/114/145Kw	2009>		
	RIFERIMENTI ORIGINALI			
← Lungh. Tot. = 662 mm → Cave 30 Cave 28	49500-2B320 49500-2B360 49500-2B750 49500-2P100	49500-2B610 49501-2B700 49501-2P000	← Lungh. Tot. = 610 mm → Cave int 26 Cave 30	
LATO SX	HU 00152		HU 00153	LATO DX
NOTE ABS 52				



Sportage	2.0 4WD 70Kw 2.0 i 16V 94Kw	94>99 99>03	2.0 i 16V 4WD 94Kw	94>03
	RIFERIMENTI ORIGINALI			
← Lungh. Tot. = 519 mm → Cave 26 Cave int. 26	0K01225500AB	0K01225600AB	← Lungh. Tot. = 572 mm → Cave 26 Cave 25	
LATO SX	KI 00127		KI 00128	LATO DX
NOTE				

Sportage		2.7 V6 4WD 129Kw	04>09		
 <p>← Lungh. Tot. = 670 mm → Cave 27 Cave 27</p> <p>LATO SX HU 00148</p>	RIFERIMENTI ORIGINALI		49501-1F200 49501-2E400 49501-2E500	49500-2E550	 <p>← Lungh. Tot. = 610 mm → Cave 24 Cave 27</p> <p>HU 00149 LATO DX</p>
	NOTE ABS48				

Sportage		2.0 CRDI AWD	2010>		
 <p>← Lungh. Tot. = 690 mm → Cave 30 Cave 27</p> <p>LATO SX KI 00129</p>	RIFERIMENTI ORIGINALI		495012Y900 49502Y900 49502Y100	495012Y050	 <p>← Lungh. Tot. = 585 mm → Cave 28 Cave 30</p> <p>KI 00130 LATO DX</p>
	NOTE ABS 48				

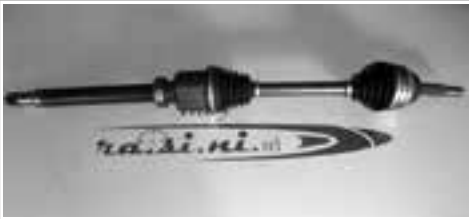
Sportage		2.0 CRDI 100Kw	2010>		
 <p>← Lungh. Tot. = 690 mm → Cave 30 Cave 27</p> <p>LATO SX KI 00129</p>	RIFERIMENTI ORIGINALI		495012Y900 495002Y900 495002Y100		 <p>← Lungh. Tot. = 980 mm → Cave 27 Cave 30</p> <p>KI 00131 LATO DX</p>
	NOTE				

Sportage		2.0 CRDI AWD	2010>		
 <p>← Lungh. Tot. = 690 mm → Cave 30 Cave 27</p> <p>LATO SX KI 00129</p>	RIFERIMENTI ORIGINALI		495012Y900 49502Y900 495002Y100		 <p>← Lungh. Tot. = 989 mm → Cave 28 Cave 30</p> <p>KI 00130/M LATO DX</p>
	NOTE				

Sportage	2.0 CRDI 83/100/103Kw	Dal 2004>	2.0 CRDI 4WD 83/100/103/110Kw	2004>
	RIFERIMENTI ORIGINALI			
← Lungh. Tot. = 650 mm → Cave 30 Cave 28	495011F350	495001F710	← Lungh. Tot. = 610 mm → Cave 28 Int. Cave 30	
LATO SX	KI 00170		KI 00171	LATO DX

NOTE

	RIFERIMENTI ORIGINALI			
← →			← →	
LATO SX				LATO DX

NOTE

	RIFERIMENTI ORIGINALI			
← →			← →	
LATO SX				LATO DX

NOTE

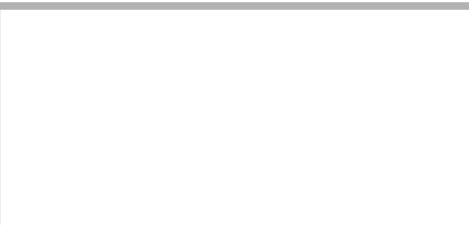
	RIFERIMENTI ORIGINALI			
← →			← →	
LATO SX				LATO DX

NOTE

Niva		1.6 1.7	1993> 1.9 D 1993>	1993>
		RIFERIMENTI ORIGINALI		
← Lungh. Tot. = 705 mm → Cave 22 Cave 22		← Lungh. Tot. = 830 mm → Cave 22 Cave 22		
LATO SX	LD 00101		LD 00102	LATO DX

NOTE

		RIFERIMENTI ORIGINALI		
← →		← →		
LATO SX				LATO DX



NOTE



		RIFERIMENTI ORIGINALI		
← →		← →		
LATO SX				LATO DX



NOTE



		RIFERIMENTI ORIGINALI		
← →		← →		
LATO SX				LATO DX

NOTE

Delta	1.9 MJT 140Kw	2008>		
	RIFERIMENTI ORIGINALI			
← Lungh. Tot. = 630 mm → Cave 25 Cave 25				← Lungh. Tot. = 935 mm → Cave 25 Cave 25
LATO SX FI 01061				FI 01062 LATO DX
NOTE Fonico Ø 59				

Delta III	1.4 TJet 88/110Kw	2008>		
	RIFERIMENTI ORIGINALI			
← Lungh. Tot. = 630 mm → Cave 25 Cave 25		51794995		← Lungh. Tot. = 930 mm → Cave 25 Cave 25
LATO SX FI 01063		Fusello Ø 35 Fusello L/C 367mm		FI 01064 LATO DX
NOTE Fonico Ø 51				

Delta III	1.4 16v 103Kw 1.4 BI 88Kw	07/2010> 07/2011>	1.6 MJet 77/88Kw 2.0 MJet 121Kw	2011> 2011>
	RIFERIMENTI ORIGINALI			
← Lungh. Tot. = 610 mm → Cave 25 Cave 25	51868091		Paraolio Ø 30 Fusello L/C 410mm Staffa 62mm	← Lungh. Tot. = 960 mm → Cave 25 Cave 25
LATO SX LA 00150	Paraolio Ø 32			LA 00151 LATO DX
NOTE Fonico Ø 51				

Delta III	1.4 16v 103Kw 1.4 BI 88Kw	07/2010> 07/2011>	1.6 MJet 77/88Kw 2.0 MJet 121Kw	2011> 2011>
	RIFERIMENTI ORIGINALI			
← Lungh. Tot. = 610 mm → Cave 25 Cave 25	51868091		Paraolio Ø 30 Fusello L/C 410mm Staffa 67mm	← Lungh. Tot. = 960 mm → Cave 25 Cave 25
LATO SX LA 00150	Paraolio Ø 32			LA 00151 LATO DX
NOTE Fonico Ø 51				

Delta III

1.6 MJet 88Kw

2008>



← Lungh. Tot. = 630 mm →
Cave 25 Cave 25

LATO SX

FI 01010

RIFERIMENTI ORIGINALI

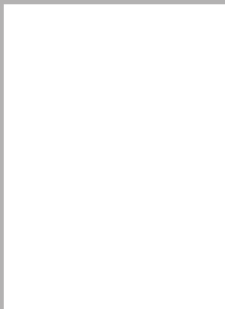

← Lungh. Tot. = 935 mm →
Cave 25 Cave 25

FI 01011

LATO DX

NOTE Fonico Ø 51

Delta III

1.6 MJT 88Kw
Camb: Aut.

2008>



← Lungh. Tot. = 607 mm →
Cave 25 Cave 25

LATO SX

LA 00146

RIFERIMENTI ORIGINALI

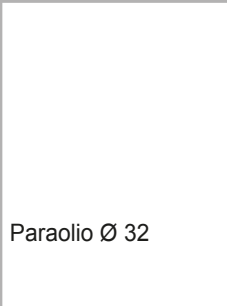

← Lungh. Tot. = 942 mm →
Cave 25 Cave 25

LA 00147

LATO DX

NOTE Fonico Ø 51 - Parap. Ø 73

Delta III

1.9 JTD 140Kw
2.0 D MJ 120Kw

2009>

2008>



← Lungh. Tot. = 610 mm →
Cave 27 Cave 27

LATO SX

LA 00148

RIFERIMENTI ORIGINALI

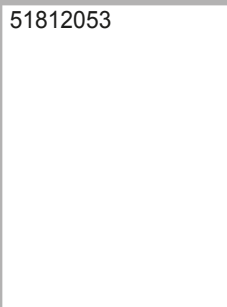

← Lungh. Tot. = 951 mm →
Cave 27 Cave 27

LA 00149

LATO DX

NOTE Fonico Ø 59

Kappa

2.0 20v 107/114Kw

1994>



← Lungh. Tot. = 520 mm →
Cave 27 Ø 100

LATO SX

LA 00107

RIFERIMENTI ORIGINALI

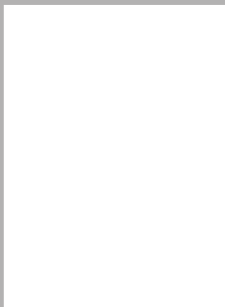
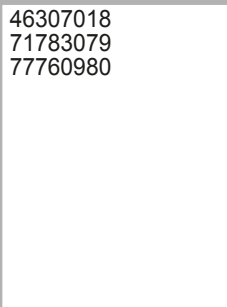





← Lungh. Tot. = 520 mm →
Ø 100 Cave 27



LA 00107

LATO DX

NOTE ABS 44D

Kappa	2.0 16V Turbo-SW 151/162Kw	1995>	3.0 24v SW-Coupé 150Kw	1994>
RIFERIMENTI ORIGINALI				
	7776114			
← Lungh. Tot. = 527 mm → Cave 27 Ø 108			← Lungh. Tot. = 527 mm → Ø 108 Cave 27	
LATO SX	LA 00108		LA 00108	
NOTE ABS 44D				

Kappa	2.4 TD 91Kw 2.4 20v 129Kw	94>98 94>98		
RIFERIMENTI ORIGINALI				
	46423947 7776119			
← Lungh. Tot. = 510 mm → Cave 27 Ø 108 H 49			← Lungh. Tot. = 510 mm → Ø 108 H 49 Cave 27	
LATO SX	LA 00109		LA 00109	
NOTE ABS 44D				

Kappa	2.4 JTD 100Kw	1998>		
RIFERIMENTI ORIGINALI				
	46307306			
← Lungh. Tot. = 505 mm → Cave 27 Ø 108 H 49			← Lungh. Tot. = 505 mm → Ø 108 H 49 Cave 27	
LATO SX	LA 00110		LA 00110	
NOTE Fonico Ø 59				

Lybra	1.6 16v 76Kw	1999>		
RIFERIMENTI ORIGINALI				
	46307564		46307647	
← Lungh. Tot. = 612 mm → Cave 25 Rullo 32			← Lungh. Tot. = 948 mm → Rullo 32 Cave 25	
LATO SX	LA 00123		LA 00124	
NOTE Fonico Ø 51				

Lybra

1.8 16v

1999>



← Lungh. Tot. = 590 mm →
Cave 25 Ø 100

LATO SX

LA 00111

RIFERIMENTI ORIGINALI

46307569



← Lungh. Tot. = 590 mm →
Ø 100 Cave 25

LA 00111

LATO DX

NOTE Fonico Ø 51

Lybra

2.4 JTD 99/103/110Kw
2.4 JTD Aut. 99Kw1999>
1999>

← Lungh. Tot. = 575 mm →
Cave 25 Cave 25

LATO SX

LA 00112

RIFERIMENTI ORIGINALI

46307735

46307741

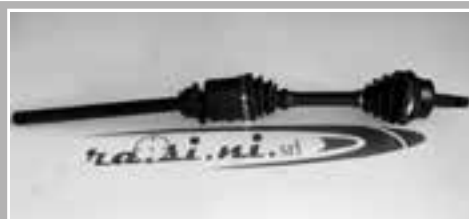

← Lungh. Tot. = 980 mm →
Cave 25 Cave 25

LA 00113

LATO DX

NOTE Fonico Ø 59

Lybra

1.9 JTD 77/81/85Kw

99>02



← Lungh. Tot. = 516 mm →
Cave 25 Ø 108 H 49

LATO SX

AR 00113

RIFERIMENTI ORIGINALI

46548056

46508055
46548165

← Lungh. Tot. = 516 mm →
Ø 108 H 32 Cave 25

AR 00114

LATO DX

NOTE Fonico Ø 59

Lybra

1.9 JTD 85Kw

2002>



← Lungh. Tot. = 615 mm →
Cave 25 Cave 25

LATO SX

AR 00125

RIFERIMENTI ORIGINALI

46308071

46308024
46308072

← Lungh. Tot. = 935 mm →
Cave 25 Cave 25

AR 00126

LATO DX

NOTE Fonico Ø 59

Musa 1.3 Multijet 66Kw 09/2006>		RIFERIMENTI ORIGINALI	
<p>← Lungh. Tot. = 580 mm → Cave 25 Cave 24</p> <p>LATO SX LA 00114</p>	<p>46308366* 46308409 46308523 51934092*</p>	<p>51785203 46308524</p>	<p>← Lungh. Tot. = 902 mm → Cave 24 Cave 25</p> <p>LATO DX LA 00115</p>
<p>NOTE Fonico Ø 51</p>			

Musa 1.3 Multijet 51Kw 2004>		RIFERIMENTI ORIGINALI	
<p>← Lungh. Tot. = 505 mm → Cave 25 Ø 100</p> <p>LATO SX LA 00127</p>	<p>46308079</p>	<p>46308080</p>	<p>← Lungh. Tot. = 520 mm → Ø 100 Cave 25</p> <p>LATO DX LA 00128</p>
<p>NOTE Fonico Ø 51</p>			

Musa 1.6 MJet 88Kw 05/2008>		RIFERIMENTI ORIGINALI	
<p>← Lungh. Tot. = 610 mm → Cave 25 Cave 25</p> <p>LATO SX FI 01130</p>	<p>51800456</p>	<p>51800455</p>	<p>← Lungh. Tot. = 877 mm → Cave 25 Cave 25</p> <p>LATO DX FI 01131</p>
<p>NOTE Fonico Ø 51</p>			

Musa 1.9 JTD 74Kw 2004>		RIFERIMENTI ORIGINALI	
<p>← Lungh. Tot. = 607 mm → Cave 25 Cave 34</p> <p>LATO SX LA 00118</p>	<p>46308068 46308073 51813089</p>	<p>46308069 46308074 51813090</p>	<p>← Lungh. Tot. = 874 mm → Cave 34 Cave 25</p> <p>LATO DX LA 00119</p>
<p>NOTE Fonico Ø 51 - Parap. Ø 71</p>			

Musa

1.4 70Kw
1.4 57Kw LPG2003>
2004>

RIFERIMENTI ORIGINALI

46308093
46308094
51753392

46308147

← Lungh. Tot. = 635 mm →
Cave 22 Cave 22

LATO SX

LA 00125

← Lungh. Tot. = 870 mm →
Cave 22 Cave 22

LA 00126

LATO DX

NOTE Fonico Ø 51

Phedra

2.0 JTD 79/80Kw

03>10

RIFERIMENTI ORIGINALI

← Lungh. Tot. = 642 mm →
Cave 27 Cave 37

LATO SX

LA 00160

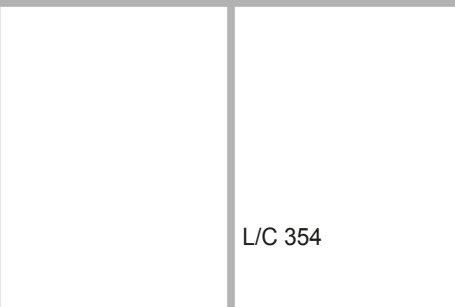

L/C 354

← Lungh. Tot. = 968 mm →
Cave 37 Cave 27

LA 00161

LATO DX

NOTE

Phedra

2.0 JTD 88Kw
2.0 DM JTD 100Kw06>10
06>10

RIFERIMENTI ORIGINALI

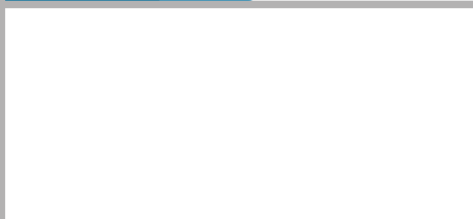
3272AW
3272GY
3272GZ3273PS
3273RY
3273RZ← Lungh. Tot. = 642 mm →
Cave 27 Cave 37

LATO SX

LA 00160

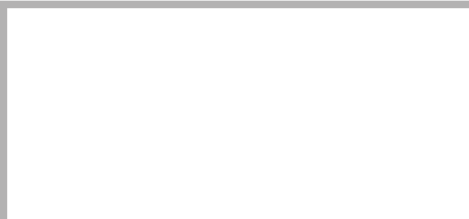

Fusello L/C 383mm

← Lungh. Tot. = 970 mm →
Cave 37 Cave 27

LA 00162

LATO DX

NOTE

Phedra

2.2 JTD 94Kw

2002>2010

RIFERIMENTI ORIGINALI

9645249280

9645249380
3273LA
3273HV
3273MW← Lungh. Tot. = 631 mm →
Cave 27 Cave 37

LATO SX

LA 00152



Fusello L/C 354mm

← Lungh. Tot. = 980 mm →
Cave 37 Cave 27

LA 00153

LATO DX



NOTE



Thema	2.0 IE 16v 2.5 TD	84>87 2.0 T 16v 84>87 2.8 V6	84>87 84>87
	RIFERIMENTI ORIGINALI		
← Lungh. Tot. = 518 mm → Cave 25 Ø 100			← Lungh. Tot. = 518 mm → Ø 100 Cave 25
LATO SX FI 00153 - FI 00153/A			FI 00153 - FI 00153/A LATO DX
NOTE ABS 90D su richiesta			



Thema	2.0 IE 2.0 IE T	87>92 2.5 TD 87>92 2.8 V6	87>92 87>92
	RIFERIMENTI ORIGINALI		
← Lungh. Tot. = 525 mm → Cave 25 Ø 100	A = ABS 44	A = ABS 44	← Lungh. Tot. = 525 mm → Ø 100 Cave 25
LATO SX FI 00154 - FI 00154/A			FI 00154 - FI 00154/A LATO DX
NOTE ABS 44-90D			



Thema	2.0 16v 2.0 T 16v	1992> 2.5 TD 1992> 2.8	1992> 1992>
	RIFERIMENTI ORIGINALI		
← Lungh. Tot. = 523 mm → Cave 27 Ø 100	A = ABS 44	A = ABS 44	← Lungh. Tot. = 523 mm → Ø 100 Cave 27
LATO SX FI 00155 - FI 00155/A			FI 00155 - FI 00155/A LATO DX
NOTE su richiesta			

Thesis	2.4 JTD C.A. 129/136Kw 2.4 V6 C.A. 125kw	2003> 3.0 V6 158Kw 2002> 3.2 V6 169Kw	2002> 2003>
	RIFERIMENTI ORIGINALI		
← Lungh. Tot. = 590 mm → Cave 27 Cave 26		Fusello L/C 420mm	← Lungh. Tot. = 990 mm → Cave 26 Cave 27
LATO SX LA 00134			LA 00135 LATO DX
NOTE ABS 44D su richiesta - Parap. Ø 31			



Thesis	2.0 T 136Kw 2.4 JTD 110Kw	2002> 2.4 V6 125Kw 2002>	2002>
	RIFERIMENTI ORIGINALI		
← Lungh. Tot. = 630 mm → Cave 27 Cave 25			← Lungh. Tot. = 985 mm → Cave 25 Cave 27
LATO SX LA 00131			LA 00132 LATO DX
NOTE Fonico Ø 59			



Thesis	2.4 JTD 129/136Kw	2003>	
	RIFERIMENTI ORIGINALI		
← Lungh. Tot. = 615 mm → Cave 27 Cave 27			← Lungh. Tot. = 1000 mm → Cave 27 Cave 27
LATO SX LA 00136			LA 00137 LATO DX
NOTE Fonico Ø 59			

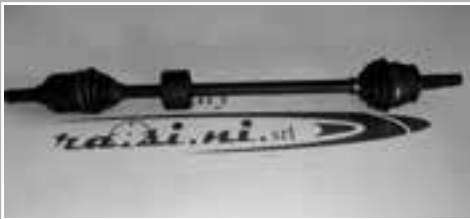

Ypsilon	1.1 40Kw 1.2 8v 44Kw	1996> 1.2 16v 55Kw 96>00 1.2 16v 59Kw	1996> 1.4 12v 55/59Kw 1996>	1996>
	RIFERIMENTI ORIGINALI			
← Lungh. Tot. = 586 mm → Cave 22 Cave 22	46307151* 7740977	46307147* 7794472	← Lungh. Tot. = 870 mm → Cave 22 Cave 22	
LATO SX FI 00108 - FI 00108/A*	A = ABS 44	A = ABS 44	FI 00109 - FI 00109/A* LATO DX	
NOTE				

Ypsilon	1.2 8v 1.2 16v	00>03 1.4 12v 59Kw 2000>	96>03
	RIFERIMENTI ORIGINALI		
← Lungh. Tot. = 586 mm → Cave 22 Cave 22	46307553 46554027	46307558	← Lungh. Tot. = 865 mm → Cave 22 Cave 22
LATO SX LA 00121			LA 00122 LATO DX
NOTE Fonico Ø 51			

Ypsilon	1.2 44/59Kw 1.4 70Kw	2003> 2003>	RIFERIMENTI ORIGINALI	
		46308093 46308094 51753392	46308147	
← Lungh. Tot. = 635 mm → Cave 22 Cave 22				← Lungh. Tot. = 870 mm → Cave 22 Cave 22
LATO SX	LA 00125			LA 00126
NOTE Fonico Ø 51				

Ypsilon	1.2 51Kw	05/2011>	RIFERIMENTI ORIGINALI	
		51902278	51839645	
← Lungh. Tot. = 651 mm → Cave 22 Cave 22				← Lungh. Tot. = 850 mm → Cave 22 Cave 22
LATO SX	FI 01035			FI 01036
NOTE Fonico Ø 51				

Ypsilon	1.3 MJet 70Kw	2011>	RIFERIMENTI ORIGINALI	
		51839650	51839646	
← Lungh. Tot. = 570 mm → Cave 25 Cave 24			Fusello L/C 360mm	← Lungh. Tot. = 880 mm → Cave 24 Cave 25
LATO SX	FI 01124			FI 01125
NOTE Fonico Ø 51				

Ypsilon	1.3 Multijet 51Kw	2003>	RIFERIMENTI ORIGINALI	
				
← Lungh. Tot. = 490 mm → Cave 25 Ø 100				← Lungh. Tot. = 510 mm → Ø 100 Cave 25
LATO SX	LA 00116			LA 00117
NOTE Fonico Ø 51				

Ypsilon

1.3 MJT 77Kw

2007>



← Lungh. Tot. = 588 mm →
Cave 25 Cave 24

LATO SX

LA 00129

RIFERIMENTI ORIGINALI

46308409
4630852346308410
46308437
46308524
51785203

← Lungh. Tot. = 905 mm →
Cave 24 Cave 25

LA 00130

LATO DX

NOTE Fonico Ø 51

Ypsilon

1.3 MJet 55Kw

2006>



← Lungh. Tot. = 623 mm →
Cave 25 Cave 24

LATO SX

FI 01012

RIFERIMENTI ORIGINALI

46308345
5180810646308329
46308522

← Lungh. Tot. = 905 mm →
Cave 24 Cave 25

FI 01013

LATO DX

NOTE Fonico Ø 51

Ypsilon

1.3 MJet 66Kw

2006>



← Lungh. Tot. = 583 mm →
Cave 25 Cave 24

LATO SX

LA 00140

RIFERIMENTI ORIGINALI

46308330
5180810846308324
51808105

← Lungh. Tot. = 954 mm →
Cave 24 Cave 25

LA 00141

LATO DX

NOTE

Ypsilon

1.3 MJet 77Kw

07>11



← Lungh. Tot. = 585 mm →
Cave 25 Cave 24

LATO SX

LA 00142

RIFERIMENTI ORIGINALI



46308409
4630852346308410
46308437
46308524
51785203



← Lungh. Tot. = 895 mm →
Cave 24 Cave 25



LA 00143

LATO DX

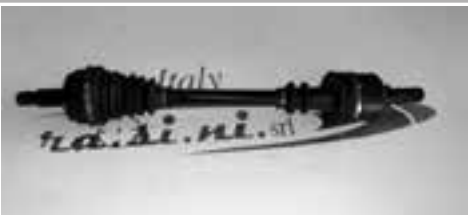
NOTE Fonico Ø 51

Zeta		2.0 Turbo 108Kw 2.1 Turbo Diesel 80Kw	1994> 1996>		
 <p>← Lungh. Tot. = 640 mm → Cave 27 Cave 37</p>	RIFERIMENTI ORIGINALI		 <p>← Lungh. Tot. = 940 mm → Cave 37 Cave 27</p>		
	<p>32723L* 3272K8 3272L0 3272V0*</p>	<p>327306* 327315* 3273S1* 3273S2 3273S4</p>		<p>A = ABS 48</p>	<p>A = ABS 48</p>
LATO SX		FI 00122 - FI 00122/A*		FI 00123 - FI 00123/A* LATO DX	
NOTE Fonico Ø 51					

Zeta		2.0 I 89/90Kw	1994>		
 <p>← Lungh. Tot. = 648 mm → Cave 27 Cave 24</p>	RIFERIMENTI ORIGINALI		 <p>← Lungh. Tot. = 930 mm → Cave 24 Cave 27</p>		
	<p>3272L9 3272L9* 3272M0 3272P5* 9619947588</p>	<p>32735X* 3273T4 3272V7* 9619947688</p>		<p>A = ABS 48</p>	<p>A = ABS 48</p>
LATO SX		FI 00120 - FI 00120/A*		FI 00121 - FI 00121/A* LATO DX	
NOTE ABS 48D su richiesta					

Zeta		2.0 JTD 80Kw	99>02		
 <p>← Lungh. Tot. = 630 mm → Cave 27 Cave 37</p>	RIFERIMENTI ORIGINALI		 <p>← Lungh. Tot. = 955 mm → Cave 37 Cave 27</p>		
	<p>1481452080</p>	<p>1481449080 1481451080</p>		<p>A = ABS 48</p>	<p>A = ABS 48</p>
LATO SX		FI 00136 - FI 00136/A		FI 00137 - FI 00137/A LATO DX	
NOTE					

		RIFERIMENTI ORIGINALI			
←				←	
LATO SX				LATO DX	
NOTE					

Evoque

2.0 16v 177Kw C. Aut.

2015>



← Cave 31 →
Cave 28

LATO SX

RO 00150

RIFERIMENTI ORIGINALI

LR061554
LR024759LR061603
LR024755

Fusello L/C 545mm



← Lugh. Tot. = 1020 mm →
Cave 28 Cave 31

RO 00151

LATO DX

NOTE

Evoque

2.2 SD4 140Kw

2011>

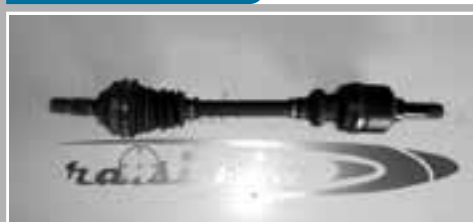

← Cave 31 →
Cave 28

LATO SX

RO 00152

RIFERIMENTI ORIGINALI

LR024758

LR024754



← Lugh. Tot. = 1045 mm →
Cave 28 Cave 31

RO 00153

LATO DX

NOTE

Freelander

1.8 l 16v 86/88Kw
Fino al telaio 1A999999

98>06

2.0 DI 72Kw
Fino al telaio 1A999999

98>00



← Lugh. Tot. = 610 mm →
Cave 28 Cave 25

LATO SX

RO 00136

RIFERIMENTI ORIGINALI



← Lugh. Tot. = 610 mm →
Cave 25 Cave 28

RO 00136

LATO DX

NOTE ABS = 60 cave

Freelander

2.0 TD4 80/82Kw
Fino al telaio 1A999999

00>06

2.5 V6 130Kw
Fino al telaio 1A999999

00>06



← Lugh. Tot. = 630mm →
Cave 28 Cave 25

LATO SX

RO 00145

RIFERIMENTI ORIGINALI

TDB104030

TDB104020





← Lugh. Tot. = 595 mm →
Cave 25 Cave 28

RO 00146

LATO DX

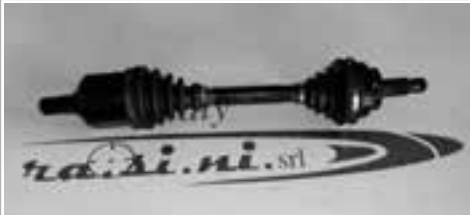
NOTE ABS = 60 cave

Freelander	2.0 TD4 80/82Kw Dal telaio 2A000001	00>06	2.5 V6 130Kw Dal telaio 2A000001	00>06
	RIFERIMENTI ORIGINALI			
← Lungh. Tot. = 630 mm → Cave 28 Cave 25			← Lungh. Tot. = 595 mm → Cave 25 Cave 28	
LATO SX	RO 00139		RO 00140	LATO DX
NOTE Fonico Ø 57,7				

Freelander	2.2 TD4 110Kw 4x4 2.2 D4 110Kw	2006> 2010>	2.2 SD4 4x4 140Kw 2.2 TD4 4x4 112/115/118Kw	10>11 2007>
	RIFERIMENTI ORIGINALI			
← Lungh. Tot. = 540 mm → Cave 40 Cave 31	LR002621 Fusello L/C 90mm	LR002618 LR006707 Fusello L/C 548mm	← Lungh. Tot. = 1020 mm → Cave 28 Cave 40	
LATO SX	RO 00155		RO 00156	LATO DX
NOTE				

RIFERIMENTI ORIGINALI				
←				→
LATO SX				LATO DX
NOTE				

RIFERIMENTI ORIGINALI				
←				→
LATO SX				LATO DX
NOTE				

121

1.3 16v 39/53kW

1990>



← Lungh. Tot. = 610 mm →
Cave 24 Cave 22

LATO SX

MZ 00101

RIFERIMENTI ORIGINALI

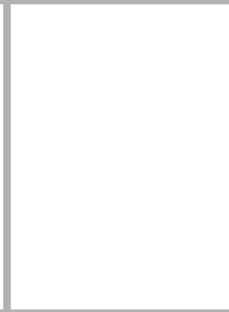
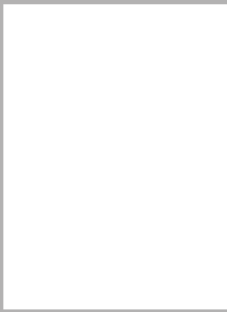

← Lungh. Tot. = 885 mm →
Cave 22 Cave 24

MZ 00102

LATO DX

NOTE

323

1.3 16v 54Kw
1.5 54/55Kw89>94 | 1.6 62/65Kw
89>94

89>94



← Lungh. Tot. = 625 mm →
Cave 26 Cave 24

LATO SX

MZ 00103 - MZ 00103/A

RIFERIMENTI ORIGINALI

FO2325600

FO2325400

ABS = 44

ABS = 44



← Lungh. Tot. = 905 mm →
Cave 24 Cave 26

MZ 00104 - MZ 00104/A

LATO DX

NOTE ABS 44D su richiesta

323

1.8 GT 16v

94>98



← Lungh. Tot. = 612 mm →
Cave 26 Cave 26

LATO SX

MZ 00105 - MZ 00105/A

RIFERIMENTI ORIGINALI

GS02-25-60XB

GS02-25-50XA



← Lungh. Tot. = 618 mm →
Cave Int. 26 Cave 26

MZ 00106 - MZ 00106/A

LATO DX

NOTE ABS 44D su richiesta

323

1.3 16v 54Kw
1.5 16v 65Kw94>98 |
94>98

← Lungh. Tot. = 640 mm →
Cave 26 Cave 24

LATO SX

MZ 00107 - MZ 00107/A

RIFERIMENTI ORIGINALI

FDY1-25-60X

FDY2-25-50X



← Lungh. Tot. = 580 mm →
Cave Int. 28 Cave 26

MZ 00108 - MZ 00108/A

LATO DX

NOTE ABS 44D su richiesta

626	1.8 66/77Kw 2.0 85Kw	91>97 90>97	RIFERIMENTI ORIGINALI		
	G568-25-600B	G568-25-500B			
← Lungh. Tot. = 632 mm → Cave 28 Cave 28	ABS = 44	ABS = 44			← Lungh. Tot. = 582 mm → Cave Int. 28 Cave 28
LATO SX MZ 00109 - MZ 00109/A					MZ 00110 - MZ 00110/A LATO DX
NOTE ABS 44D su richiesta					

626	2.0 Coupé GT 2.0 GLX	90>97 90>97	RIFERIMENTI ORIGINALI		
← Lungh. Tot. = 625 mm → Cave 28 Cave 28	ABS = 44	ABS = 44			← Lungh. Tot. = 573 mm → Cave Int. 28 Cave 28
LATO SX MZ 00111 - MZ 00111/A					MZ 00112 - MZ 00112/A LATO DX
NOTE ABS 44D su richiesta					

626	2.0 D 55Kw	92>97	RIFERIMENTI ORIGINALI		
← Lungh. Tot. = 608 mm → Cave 28 Cave 28					← Lungh. Tot. = 567 mm → Cave Int. 28 Cave 28
LATO SX MZ 00113					MZ 00114 LATO DX
NOTE ABS 44D su richiesta					

Mazda 2	1.4 50Kw	2008>	RIFERIMENTI ORIGINALI		
← Lungh. Tot. = 624 mm → Cave 25 Cave 23					← Lungh. Tot. = 922 mm → Cave 23 Cave 25
LATO SX FO 00172					FO 00173 LATO DX
NOTE					

Mazda 3		1.6 MZR CD 80/85Kw	2009>		
		RIFERIMENTI ORIGINALI			
		GG68-25-600A	GG63-25-500A		
← Lungh. Tot. = → Cave 28				← Lungh. Tot. = 586 mm → Cave 28	
LATO SX	MZ 00117			MZ 00118	LATO DX
NOTE					

Mazda 6		2.0 DI 89/100Kw	02>07		
		RIFERIMENTI ORIGINALI			
		GD402560XA	GD402550XA		
← Lungh. Tot. = 643 mm → Cave 28 Cave 30				← Lungh. Tot. = 587 mm → Cave int. 28 Cave 28	
LATO SX	MZ 00115			MZ 00116	LATO DX
NOTE ABS 44					

		RIFERIMENTI ORIGINALI			
← →				← →	
LATO SX					LATO DX
NOTE					

		RIFERIMENTI ORIGINALI			
← →				← →	
LATO SX					LATO DX
NOTE					

190 (W201)

Tutti i modelli

09/02>



← Lungh. Tot. = 635 mm →
Cave 25 Cave 27

LATO SX

ME 00134

RIFERIMENTI ORIGINALI

A2013501810

A2013501810



← Lungh. Tot. = 635 mm →
Cave 27 Cave 25

ME 00134

LATO DX

NOTE

Classe A

A 140 60Kw
A 160 75Kw

97>04
97>04

A 170 CDI 70Kw

97>04



← Lungh. Tot. = 570 mm →
Cave 24 Cave 22

LATO SX

ME 00105

RIFERIMENTI ORIGINALI

A1683603172

A1683603372



← Lungh. Tot. = 955 mm →
Cave 22 Cave 24

ME 00106

LATO DX

NOTE

Classe A e B

A 150 70Kw, A 160 CDI 60Kw, A 170 85Kw, A 200 100Kw 2004> | B 150 70Kw, B 170 85Kw, B 200 100Kw

2004>

2005>



← Lungh. Tot. = 610 mm →
Cave 25 Cave 22

LATO SX

ME 00109 - ME 00111

RIFERIMENTI ORIGINALI

A1693601172

A1693601272
1693608272

Fusello L/C 460mm



← Lungh. Tot. = 990 mm →
Cave 22 Cave 25

ME 00110 - ME 00112

LATO DX

NOTE Fonico Ø 60,2

Classe A e B

A 180 CDI 80Kw, A 200 CDI 103Kw

2004>
2004>

B 180 CDI 80Kw, B 200 CDI 103Kw

2004>
2004>



← Lungh. Tot. = 590 mm →
Cave 25 Cave 27

LATO SX

ME 00115-00113-00117

RIFERIMENTI ORIGINALI

1693602972
1693603372

1693601572
1693603272
1693605672



← Lungh. Tot. = 993 mm →
Cave 27 Cav e 25



ME 00114-00116-00118

LATO DX

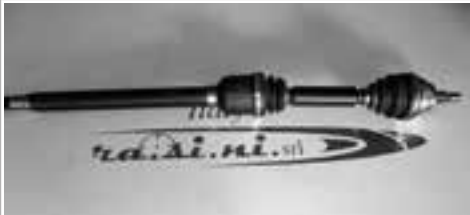

NOTE Fonico Ø 60,2

Classe A e B	A 180 CDI C.A. 80Kw A 200 CDI C.A. 103Kw	2004> 2004>	B 180 CDI C.A. 80Kw B 200 CDI C.A. 103Kw	2005> 2005>
	RIFERIMENTI ORIGINALI			
	A1693701572 A1693702772		A1693702872 1693705672	
← Lungh. Tot. = 610 mm → Cave 25 Cave 27				← Lungh. Tot. = 950 mm → Cave 27 Cav e 25
LATO SX	ME 00123 - ME 00127		ME 00124 - ME 00128 LATO DX	



NOTE Fonico Ø 60

Classe A e B	A 150 70Kw, A 160 CDI 60Kw A 170 85Kw, A 200 100Kw	2004>	B 150 70Kw, B 170 85Kw B 200 100Kw	2005>
	RIFERIMENTI ORIGINALI			
	A1693601172		1693605272	
← Lungh. Tot. = 610 mm → Cave 25 Cave 22		Fusello L/C 460mm		← Lungh. Tot. = 977 mm → Cave 22 Cave 25
LATO SX	ME 00109 - ME 00111		ME 00142 LATO DX	



NOTE Fonico Ø 60,2



Classe A e B	A 160 -180 75/90Kw B 160 -180 75/90Kw	2015> 2015>	CLA 180 90Kw	2013>
	RIFERIMENTI ORIGINALI			
	A2463302700 A2463308800 A2463307600		A2463308900 A2463307700 A2463302800	
← Lungh. Tot. = 532 mm → Cave 30 Cave 27				← Lungh. Tot. = 500 mm → Cave interne 27 Cave 30
LATO SX	ME 00143		ME 00144 LATO DX	



NOTE



Classe A e B (Aut.)	A 150 C.A. 70Kw A 160 CDI C.A. 60KW	2004> 2004>	A 170 C.A. 85Kw A 200 C.A. 100Kw	2004> 2004>
	RIFERIMENTI ORIGINALI			
	1693706372		1693701272 1693706472	
← Lungh. Tot. = 614 mm → Cave 25 Cave 27				← Lungh. Tot. = 950 mm → Cave 27 Cave 25
LATO SX	ME 00125		ME 00126 LATO DX	

NOTE Fonico Ø 60

Classe C		Tutti i modelli	93>01	
 <p>← Lungh. Tot. = 645 mm → Cave 25 Ø 100</p> <p>LATO SX ME 00120 - ME 00120/A*</p>	RIFERIMENTI ORIGINALI		 <p>← Lungh. Tot. = 645 mm → Ø 100 Cave 25</p> <p>ME 00120 - ME 00120/A* LATO DX</p>	
	A2023508410*	A = ABS 48		A = ABS 48
NOTE ABS 48 su richiesta				

Classe R		Tutti i modelli	2006>	
 <p>← Lungh. Tot. = 682 mm → Cave 30 Cave 37</p> <p>LATO SX ME 00121</p>	RIFERIMENTI ORIGINALI		 <p>← Lungh. Tot. = 1018 mm → Cave 37 Cave 30</p> <p>ME 00122 LATO DX</p>	
	A2513301701 A2513302101	A2513300601 A2513301401		
NOTE				

CLK		Tutti i modelli	09/02>	
 <p>← Lungh. Tot. = 775 mm → Cave 25 Cave 27</p> <p>LATO SX ME 00133</p>	RIFERIMENTI ORIGINALI		 <p>← Lungh. Tot. = 775 mm → Cave 27 Cave 25</p> <p>ME 00133 LATO DX</p>	
	A2033502610	A2033502610		
NOTE				

E (W210)		Tutti i modelli	09/02>	
 <p>← Lungh. Tot. = 675 mm → Cave 25 Ø 100</p> <p>LATO SX ME 00135</p>	RIFERIMENTI ORIGINALI		 <p>← Lungh. Tot. = 675 mm → Ø 100 Cave 25</p> <p>ME 00135 LATO DX</p>	
	A2103508210	A2103508210		
NOTE				

GL

GL 320 CDI 4-Matic 155/165Kw
GL 450 4-Matic 4.6 250Kw

GL 500 4-Matic 5.4 285Kw

← Lungh. Tot. = 660 mm →
Cave 30 Cave 37

LATO SX

ME 00145

RIFERIMENTI ORIGINALI

1643302001

1643302101

← Lungh. Tot. = 1000 mm →
Cave 37 Cave 30

ME 00146

LATO DX

NOTE

MB

MB 100 D 41Kw
MB 120 53Kw90>94 | MB 140 55Kw
88>92

90>96

← Lungh. Tot. = 730 mm →
Cave 30 Cave Int. 30

LATO SX

ME 00101

RIFERIMENTI ORIGINALI

A6313300501
A6313300701
A6313301301← Lungh. Tot. = 730 mm →
Cave Int. 30 Cave 30

ME 00101

LATO DX

NOTE

MB

MB 100 D 41Kw
MB 120 53Kw90>94 | MB 140 55Kw
88>92

90>96

← Lungh. Tot. = 715 mm →
Cave 30 Cave Int. 30

LATO SX

ME 00102

RIFERIMENTI ORIGINALI

← Lungh. Tot. = 715 mm →
Cave Int. 30 Cave 30

ME 00102

LATO DX

NOTE

ML Anteriore

Tutti i modelli

98>05

← Lungh. Tot. = 630 mm →
Cave 30 Cave 37

LATO SX

ME 00130



RIFERIMENTI ORIGINALI



A1633300101
A1633300401A1633300201
A1633300301
A1633300501← Lungh. Tot. = 960 mm →
Cave 37 Cave 30



ME 00108



LATO DX



NOTE ABS 48D



ML Anteriore		Tutti i modelli	2005>	
 <p>← Lungh. Tot. = 665 mm → Cave 30 Cave 37</p> <p>LATO SX ME 00131</p>	RIFERIMENTI ORIGINALI		 <p>← Lungh. Tot. = 1000 mm → Cave 37 Cave 30</p> <p>ME 00132 LATO DX</p>	
	A1643302301 A1643302701	A1643302401 A1643302801		
NOTE				

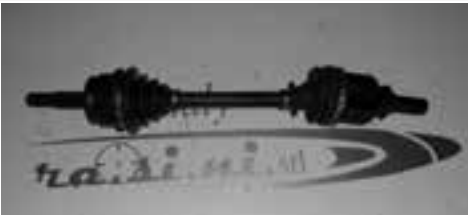

ML Posteriore		Tutti i modelli	98>05	
 <p>← Lungh. Tot. = 793 mm → Cave 30 Cave 32</p> <p>LATO SX ME 00107</p>	RIFERIMENTI ORIGINALI		 <p>← Lungh. Tot. = 793 mm → Cave 32 Cave 30</p> <p>ME 00107 LATO DX</p>	
	A1633500110 A1533500210	ABS 48		
NOTE ABS 48D				



Smart For Two		Tutti i modelli	01/2007>	
 <p>← Lungh. Tot. = 525 mm → Cave 33 Cave 33</p> <p>LATO SX SM 00107</p>	RIFERIMENTI ORIGINALI		 <p>← Lungh. Tot. = 770 mm → Cave 33 Cave 33</p> <p>SM 00108 LATO DX</p>	
	A451-357-05-01	A451-357-06-01		
NOTE				



Smart For Two		Tutti i modelli Bz	1998>	
 <p>← Lungh. Tot. = 480 mm → Cave 24 Cave 33</p> <p>LATO SX SM 00101</p>	RIFERIMENTI ORIGINALI		 <p>← Lungh. Tot. = 713 mm → Cave 33 Cave 24</p> <p>SM 00102 LATO DX</p>	
NOTE ABS 42				



Smart For Four	1.1 47/55Kw 1.3 70Kw	2004> 2004>		
	RIFERIMENTI ORIGINALI			
← Lungh. Tot. = 630 mm → Cave 25 Cave 33			← Lungh. Tot. = 920 mm → Cave 33 Cave 25	
LATO SX SM 00103			SM 00104 LATO DX	
NOTE Campana L/R Ø 82				

Smart For Four	1.5 D 80/90Kw	2005>		
	RIFERIMENTI ORIGINALI			
← Lungh. Tot. = 618 mm → Cave 25 Cave 34			← Lungh. Tot. = 907 mm → Cave 34 Cave 25	
LATO SX SM 00105			SM 00106 LATO DX	
NOTE Campana L/R Ø 82				

Viano	2.0 80Kw 2.2 110Kw	03>13 03>13	3.2 140/160Kw 3.7 170Kw	03>05 04>13
	RIFERIMENTI ORIGINALI			
← Cave 30 →		A6393500710 A6393501510	← Lungh. Tot. = 864 mm → Cave int. 26 Cave 30	
LATO SX ME 00140			ME 00141 LATO DX	
NOTE				

Vito	2.3 Diesel 58Kw 2.3 TD 72Kw	1996> 1996>	2.0 95Kw 2.3 105Kw	1996> 1996>
	RIFERIMENTI ORIGINALI			
← Lungh. Tot. = 535 mm → Cave 27 Ø 108	6383340534 6383340634 6383341634		A = ABS 48	A = ABS 48
LATO SX ME 00103 - ME 00103/A			ME 00103 - ME 00103/A LATO DX	
NOTE				



Vito		2.2 CDI 75/90Kw	1999>	
	RIFERIMENTI ORIGINALI			
	6383342334 A6383342334			
← Lungh. Tot. = 505 mm → Cave 27 Ø 122 H 38				
LATO SX ME 00104 - ME 00104/A		ME 00104 - ME 00104/A LATO DX		
NOTE				



Vito		2.0 CDI 80Kw Posteriori 109 CDI 65Kw	2003> 2000>	111 CDI 80 Kw	2003>
	RIFERIMENTI ORIGINALI				
← Lungh. Tot. = 864 mm → Cave 30 Cave 26					
LATO SX ME 00140		ME 00140 LATO DX			
NOTE					

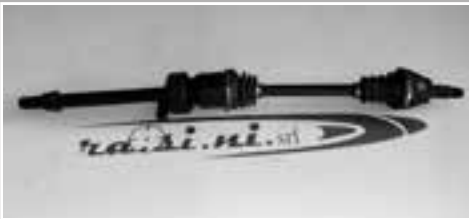

		RIFERIMENTI ORIGINALI				
						
← →					← →	
LATO SX					LATO DX	
NOTE						

		RIFERIMENTI ORIGINALI				
						
← →					← →	
LATO SX					LATO DX	
NOTE						

Cooper	1.6 ONE 66Kw 1.6 85/88Kw	01>04 01>04	
	RIFERIMENTI ORIGINALI 31607518237	31607518238	
← Lungh. Tot. = 618 mm → Cave 26 Cave 22	Fusello L/C 306mm	← Lungh. Tot. = 890 mm → Cave 22 Cave 26	
LATO SX BW 00103		BW 00104 LATO DX	
NOTE			

Cooper	ONE 1.6 66Kw 1.6 85/88Kw	2004> 2004>	
	RIFERIMENTI ORIGINALI 31607531721 31607533215	31607531722 31607533216 31607589768	
← Lungh. Tot. = 591 mm → Cave 26 Cave 33	Fusello L/C 390mm	← Lungh. Tot. = 920 mm → Cave 33 Cave 26	
LATO SX BW 01080		BW 01090 LATO DX	
NOTE			

Cooper	1.6 S 120/125Kw	2002>	
	RIFERIMENTI ORIGINALI 31607514477 31607514479 31607574852	31607514478 31607514480	
← Lungh. Tot. = 590 mm → Cave 26 Cave 34	Fusello L/C 363mm	← Lungh. Tot. = 920 mm → Cave 34 Cave 26	
LATO SX BW 00105		BW 01100 LATO DX	
NOTE			

Cooper	1.4 TDI 55/65Kw	03>06	
	RIFERIMENTI ORIGINALI 31607514479	31601503306 31607515578 31607525128	
← Lungh. Tot. = 590 mm → Cave 26 Cave 34	Fusello L/C 390mm	← Lungh. Tot. = 915 mm → Cave 34 Cave 26	
LATO SX BW 00105		BW 00106 LATO DX	
NOTE			

Cooper		One 1.4 55/70 Kw Mini 1.6 72/88/90/128 Kw	09/06> 09/06>	Mini Clubman Mini Countryman	
RIFERIMENTI ORIGINALI					
	31607589767 31602756341 31604853485 31602752251	31602756342 31607589768 31608605474			
← Lungh. Tot. = 620 mm Cave 26		Fusello L/C 390mm	← Lungh. Tot. = 900 mm Cave 33		→ Cave 26
LATO SX	BW 01081		BW 01082		LATO DX

NOTE

Cooper		1.6 88Kw Cabrio	2009>		
RIFERIMENTI ORIGINALI					
	31607589763	31607589764			
← Lungh. Tot. = 604 mm Cave 26		Fusello L/C 350mm	← Lungh. Tot. = 874 mm Cave 26		→ Cave 26
LATO SX	BW 01083		BW 01084		LATO DX

NOTE

Cooper		S16 120/128/135/147Kw One D16 66/80/82Kw	2006> 2009>	John Cooper Works 1.6 150/160Kw	08>13	Club Man (R55) 128/135/141/147/155Kw	07>15
RIFERIMENTI ORIGINALI							
	31607596059	31607616142 31607596060					
← Lungh. Tot. = 588 mm Cave 26		Fusello L/C 55mm	Fusello L/C 407mm	← Lungh. Tot. = 920 mm Cave 34		→ Cave 26	
LATO SX	BW 01085			BW 01086		LATO DX	



NOTE

Cooper		Coopers 2.0 120/135/140/147Kw	2010>	Country Man D 82/90Kw 1.6 One D 66/82Kw	2012 2010
RIFERIMENTI ORIGINALI					
	31609806469	31609806470			
← Lungh. Tot. = 620mm 26			←		→ 26
LATO SX			LATO DX		

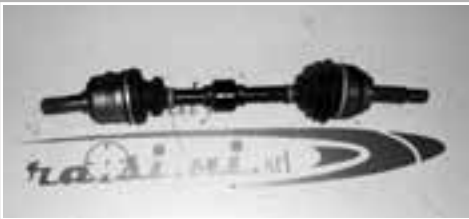

NOTE

Colt	1.2 40Kw 1.5 55Kw	86>88 1.5 Cat. 51Kw 80>88 1.8 D 46Kw	86>88 84>86
	RIFERIMENTI ORIGINALI		
← Lungh. Tot. = 925 mm → Cave 25 Cave 25			← Lungh. Tot. = 590 mm → Cave 25 Cave 25
LATO SX MI 00103			MI 00104 LATO DX



NOTE

Colt	1.3 8v 51Kw 1.3 12v 55Kw	88>92 1.5 8v 62Kw 90>92 1.5 12v 66Kw	88>92 90>92
	RIFERIMENTI ORIGINALI		
← Lungh. Tot. = 920 mm → Cave 25 Cave 25			← Lungh. Tot. = 598 mm → Cave 25 Cave 25
LATO SX MI 00101			MI 00102 LATO DX



NOTE

Colt	1.1 55Kw 1.3 70Kw	10/04>06/12 1.3 Aut. 70Kw 06/12> 1.5 80Kw	06/12> 06/12>
	RIFERIMENTI ORIGINALI		
← Lungh. Tot. = 625 mm → Cave 25 Cave 33	3815A201 MR582021 MR980747	MR582022	← Lungh. Tot. = 916 mm → Cave 33 Cave 25
LATO SX MI 00105			MI 00106 LATO DX



NOTE

Colt	1.5 DI	2003>	
	RIFERIMENTI ORIGINALI		
← Lungh. Tot. = 618 mm → Cave 25 Cave 34	3815A009	3815A188	← Lungh. Tot. = 907 mm → Cave 34 Cave 25
LATO SX MI 00107			MI 00108 LATO DX



NOTE

L 200	2.4 4WD 2.5 TD 73Kw	96>07 2.5 TD 85/89Kw 96>07 2.6 4WD	01>07 3.0 V6 4WD 110Kw 83>89 3.0 V6 24V 110/133/153Kw	90>95 97>99
	RIFERIMENTI ORIGINALI			
	MR276871	MB620834 MR276870 MR276874		
← Lungh. Tot. = 612 mm → Cave 28 Cave 25			← Lungh. Tot. = 530 mm → ø 4 Fori Cave 28	
LATO SX MI 00118			MI 00119 LATO DX	



NOTE

L200	2.5 Di-D 4WD 123Kw 2.5 Di-D 94Kw	10/07 2.5 DI-D 123Kw 2010> 2.5 DI-D 4WD 131Kw	2007> 2010>	
	RIFERIMENTI ORIGINALI			
	3815A307 MN107605	3815A308 MR580692		
← Lungh. Tot. = 592 mm → Cave 30 Cave 28			← Lungh. Tot. = 492 mm → ø 132 Cave 30	
LATO SX MI 00150			MI 00151 LATO DX	

NOTE ABS 47

Lancer	1.3 12v 1.5 8v	93>94 1.5 12v 89>90	90>93	
	RIFERIMENTI ORIGINALI			
← Lungh. Tot. = 920 mm → Cave 25 Cave 25			← Lungh. Tot. = 600 mm → Cave 25 Cave 25	
LATO SX MI 00109			MI 00110 LATO DX	

NOTE

Lancer	1.6 GLI 16v 84Kw	93>96		
	RIFERIMENTI ORIGINALI			
← Lungh. Tot. = 935 mm → Cave 25 Cave 25			← Lungh. Tot. = 590 mm → Cave 24 Cave 25	
LATO SX MI 00111			MI 00112 LATO DX	



NOTE



Lancer	1.6 16v SW	2003>	
	RIFERIMENTI ORIGINALI		
← Lungh. Tot. = → Cave Cave		← Lungh. Tot. = → Cave Cave	
LATO SX	MI 00113	MI 00114	LATO DX
NOTE			



Pajero	2.0 50/62Kw 2.3 D 50/62Kw	86>91 2.3 TD 50/62Kw 86>91 2.5 D 51kw	86>91 2.5 TD 62Kw 86>91 3.0 V6 104Kw	86>91 86>91
	RIFERIMENTI ORIGINALI			
← Lungh. Tot. = 588 mm → Cave 28 Cave 28		← Lungh. Tot. = 510 mm → ø 4 Fori Cave 28		
LATO SX	MI 00130	MI 00131	LATO DX	
NOTE				

Pajero	2.4 4WD 97Kw 2.5 TDCi 73/85/98Kw	96>07 2.8 TD 92Kw 91>99 3.0 V6 110/130/133Kw	94>99 90>99
	RIFERIMENTI ORIGINALI		
← Lungh. Tot. = 612 mm → Cave 28 Cave 25	MR276871	← Lungh. Tot. = 530 mm → ø 4 Fori Cave 28	
	MR276870 MB620834 MR276874		
LATO SX	MI 00118	MI 00119	LATO DX
NOTE			



Pajero	2.5 TDI 73Kw	2000>	
	RIFERIMENTI ORIGINALI		
← Lungh. Tot. = 605 mm → Cave 28 Cave 27	Paraolio 35mm	← Lungh. Tot. = 530 mm → ø 4 Fori Cave 28	
LATO SX	MI 00134	MI 00135	LATO DX
NOTE			



Pajero		3.2 DI-D 121Kw 3.2 DI-D 118Kw	00>01 2001>	
 <p>← Lungh. Tot. = 600 mm → Cave 30 Cave 28</p>	RIFERIMENTI ORIGINALI		 <p>← Lungh. Tot. = 520 mm → Ø 4 Fori Cave 30</p>	
	MR453383	MR453384		
LATO SX	MI 00136		MI 00137	LATO DX
NOTE ABS 50				

Pajero		2.8 TD 92Kw	1998>	
 <p>← Lungh. Tot. = 615 mm → Cave 28 Cave 28</p>	RIFERIMENTI ORIGINALI		 <p>← Lungh. Tot. = 530 mm → Ø 4 Fori Cave 28</p>	
LATO SX	MI 00154		MI 00155	LATO DX
NOTE ABS 50				



Spacestar		1.9 DI 85Kw	2001>	
 <p>← Lungh. Tot. = 610 mm → Cave 26 Cave Int. 26</p>	RIFERIMENTI ORIGINALI		 <p>← Lungh. Tot. = 960 mm → Cave 26 Cave 26</p>	
	MR912135	MR912136		
LATO SX	MI 00117		MI 00120	LATO DX
NOTE ABS 43D				



 <p>← →</p>	RIFERIMENTI ORIGINALI		 <p>← →</p>	
LATO SX				LATO DX
NOTE				

Almera	2.0 D 55Kw	95>00		
	RIFERIMENTI ORIGINALI			
← Lungh. Tot. = 590 mm → Cave 25 Cave 25	391010M970	391000M970	← Lungh. Tot. = 960 mm → Cave 25 Cave 25	
LATO SX	A = ABS 42	A = ABS 42	LATO DX	
NI 00119 - NI 00119/A			NI 00120 - NI 00120/A	
NOTE ABS 42D su richiesta				



Almera	1.4 I 55/64Kw	95>00		
	RIFERIMENTI ORIGINALI			
← Lungh. Tot. = 625 mm → Cave 25 Cave 24	391010M010	391001N010	← Lungh. Tot. = 922 mm → Cave 24 Cave 25	
LATO SX			LATO DX	
NI 00130 - NI 00130/A			NI 00131 - NI 00131/A	
NOTE				

Almera	TINO 2.2 DCI 82Kw 2.2 DI 84Kw	2003> 2000>		
	RIFERIMENTI ORIGINALI			
← Lungh. Tot. = 628 mm → Cave 27 Cave 27	3822530R00	391004U110	← Lungh. Tot. = 985 mm → Cave 27 Cave 27	
LATO SX			LATO DX	
NI 00123			NI 00124	
NOTE ABS 44D				



Interstar	1.9 DCI 60Kw	2002>		
	RIFERIMENTI ORIGINALI			
← Lungh. Tot. = 665 mm → Cave 28 Rullo Ø 37	7700102979	7711135531	← Lungh. Tot. = 1130 mm → Cave 39 Cave 28	
LATO SX	A = ABS 51	A = ABS 51	LATO DX	
RE 00185 - RE 00185/A			RE 00186 - RE 00186/A	
NOTE ABS 51D				

Interstar 2.5 DCI 88Kw 2006>		RIFERIMENTI ORIGINALI	
	3910100Q2E	3910100Q0D 8200414937	
← Lungh. Tot. = 701 mm → Cave 28 Cave 39	ABS 51		← Lungh. Tot. = 1115 mm → Cave 39 Cave 28
LATO SX RE 01193			RE 01194 LATO DX



NOTE

Juke 1.5 DCI 81Kw 2010>		RIFERIMENTI ORIGINALI	
	39101-1KC0A	39100-1KC0A	
← Lungh. Tot. = 694 mm → Cave 26 Cave 29		Fusello L/C 308mm	← Lungh. Tot. = 940 mm → Cave 29 Cave 26
LATO SX NI 00156			NI 00157 LATO DX

NOTE

Juke 1.6 DIG-T 140Kw 1.6 DIG-T 4x4 140Kw 2010>		1.6 DIG-T 160Kw 2010>	2014>
RIFERIMENTI ORIGINALI			
	39101-1KB0B	39100-1KB0B	
← Lungh. Tot. = 685 mm → Cave 29 Cave 26			← Lungh. Tot. = 950 mm → Cave 26 Cave 26
LATO SX NI 00158			NI 00159 LATO DX

NOTE

Juke 1.6 69/86Kw 2010>		RIFERIMENTI ORIGINALI	
	39101-1KA04	39100-1KA0A	
← Lungh. Tot. = 938 mm → Cave 26 Cave 29			← Lungh. Tot. = 938 mm → Cave 29 Cave 26
LATO SX NI 00160			NI 00161 LATO DX

NOTE

Micra

1.0 16v 40/44Kw

92>03



← Lungh. Tot. = 610 mm →
Cave 23 Cave 21

LATO SX **NI 00101 - NI 00101/A**

RIFERIMENTI ORIGINALI

39101-4F100

39100-4F100

A = ABS 42

A = ABS 42



← Lungh. Tot. = 825 mm →
Cave 21 Cave 23

NI 00102 - NI 00102/A LATO DX**NOTE** ABS 42D su richiesta

Micra

1.3 LX-SLX 16v 55Kw
1.4 l 16v 60Kw92>00
00>03

← Lungh. Tot. = 595 mm →
Cave 23 Cave 24

LATO SX **NI 00103 - NI 00103/A**

RIFERIMENTI ORIGINALI

30101-4F401
39101-4F60039100-4F400
39100-4F600
39101-4F400

A = ABS 42

A = ABS 42



← Lungh. Tot. = 840 mm →
Cave 24 Cave 23

NI 00104 - NI 00104/A LATO DX**NOTE** ABS 42D su richiesta

Micra

1.5 D 42Kw

98>53



← Lungh. Tot. = 630 mm →
Cave 23 Cave 22

LATO SX **NI 00113 - NI 00113/A**

RIFERIMENTI ORIGINALI

39101-6F800

39100-6F800

A = ABS 42

A = ABS 42



← Lungh. Tot. = 820 mm →
Cave 22 Cave 23

NI 00114 - NI 00114/A LATO DX**NOTE** ABS 42D su richiesta

Micra

1.5 DCI 60/65/68/82Kw

2003>



← Lungh. Tot. = 645 mm →
Cave 23 Cave 26

LATO SX **NI 00121**

RIFERIMENTI ORIGINALI

39101-AY600
39101-BC600
39101-BH00A39100-AY600
39100-BC600
39100-BH00A

← Lungh. Tot. = 895 mm →
Cave 26 Cave 23

NI 00122 LATO DX**NOTE** Fonico Ø 49

Micra	1.0 16v 48Kw 1.2 16v 48Kw	2003> 1.2 59Kw 2003> 1.4 16v 65Kw	2003>
	RIFERIMENTI ORIGINALI		
	39101-AY100 39205-AY125	39100-AY100	
← Lungh. Tot. = 643 mm → Cave 23 Cave 26			← Lungh. Tot. = 890 mm → Cave 26 Cave 23
LATO SX NI 00125			NI 00126 LATO DX

NOTE Fonico Ø 49

Micra	1.2 59Kw 1.2 DIG 72Kw	2010> 2011>	
	RIFERIMENTI ORIGINALI		
	39101-1HC3C	39100-1HC3C	
← Lungh. Tot. = 702 mm → Cave 25 Cave 25			← Lungh. Tot. = 860 mm → Cave 25 Cave 25
LATO SX NI 00164			NI 00165 LATO DX

NOTE

Primera	1.6 16v 66/75Kw	90>96	
	RIFERIMENTI ORIGINALI		
	3910170N00 3910173J00 3910173J20*	3910070N00 3910073J00 3910073J20*	
← Lungh. Tot. = 640 mm → Cave 27 Cave 25	A = ABS 42	A = ABS 42	← Lungh. Tot. = 935 mm → Cave 25 Cave 27
LATO SX NI 00107 - NI 00107/A*			NI 00108 - NI 00108/A* LATO DX

NOTE ABS 42D su richiesta

Primera	2.0 16v 85Kw 2.2 16v 4X4 85Kw	90>96 2.0 GT 110Kw 1991>	90>96
	RIFERIMENTI ORIGINALI		
	3910170J00 3910170J10* 3910171N01	3910071J00 3910071J10*	
← Lungh. Tot. = 619 mm → Cave 27 Cave 25	A = ABS 42	A = ABS 42	← Lungh. Tot. = 940 mm → Cave 25 Cave 27
LATO SX NI 00109 - NI 00109/A*			NI 00110 - NI 00110/A* LATO DX

NOTE ABS 42D su richiesta

Primera

2.0 D 55Kw

90>96



← Lungh. Tot. = 600 mm →
Cave 27 Cave 25

LATO SX **NI 00111 - NI 00111/A***

RIFERIMENTI ORIGINALI

39101-72J22

39100-72J10
39100-72J20*

← Lungh. Tot. = 963 mm →
Cave 25 Cave 27

NI 00112 - NI 00112/A* LATO DX**NOTE** ABS 42D su richiesta

Primera

1.6 16v 66/73Kw

1996>



← Lungh. Tot. = 640 mm →
Cave 27 Cave 25

LATO SX **NI 00115**

RIFERIMENTI ORIGINALI

39101-2F011

39100-9F611



← Lungh. Tot. = 920 mm →
Cave 25 Cave 27

NI 00116 LATO DX**NOTE** ABS 44D

Primera

2.0 TD 66Kw

1996>



← Lungh. Tot. = 605 mm →
Cave 27 Cave 25

LATO SX **NI 00117**

RIFERIMENTI ORIGINALI

39101-2F605
39101-2F615

39100-2F615



← Lungh. Tot. = 960 mm →
Cave 25 Cave 27

NI 00118 LATO DX**NOTE** ABS 44D

Qashqai

1.5 DCI 76/78/81Kw

2007>



← Lungh. Tot. = 695 mm →
Cave 29 Cave 26

LATO SX **NI 00133**

RIFERIMENTI ORIGINALI

39101-JD52B
39100JD02B

39100-BB32B



← Lungh. Tot. = 945 mm →
Cave 26 Cave 29

NI 00134 LATO DX**NOTE**

Qashqai	1.6 DCI 96Kw 2.0 DCI 110Kw	11>13 08>13		
	RIFERIMENTI ORIGINALI			
← Lungh. Tot. = 650 mm → Cave 29 Cave 29	39101-JD72B	39100-JD72B	← Lungh. Tot. = 982 mm → Cave 29	
LATO SX		Fusello L/C 460mm	LATO DX	
NI 00135			NI 00136	

NOTE Fonico Ø 55,7

Qashqai	1.6 B 84Kw 1.6B 86Kw	2007 2010		
	RIFERIMENTI ORIGINALI			
← 29 → 26	38225JD22B 39101JD02B	39100BB02B 39100BB	← Lungh. Tot. = 940 mm → Cave 26 Cave 29	
LATO SX		Fusello L/C 322mm	LATO DX	
NI 00162			NI 00163	

NOTE

Qashqai	2.0 D C/Autom. 2.0 D 100Kw 4x4 C/Autom.	2007> 2007>		
	RIFERIMENTI ORIGINALI			
← Lungh. Tot. = 645 mm → Cave 29 Cave 30	39101-JD74D	39100-JD74A	← Lungh. Tot. = 975 mm → Cave 30 Cave 29	
LATO SX		Paraolio Ø 32,2 Sx e Dx Fusello L/C 462mm	LATO DX	
NI 00140			NI 00141	

NOTE

Qashqai	1.6 DCI 4x4 96Kw 2.0 DCI 4x4 110Kw	11>13 07>13		
	RIFERIMENTI ORIGINALI			
← Lungh. Tot. = 620 mm → Cave 29 Cave 29	39101-JD74B	39100-JD74B	← Lungh. Tot. = 1015 mm → Cave 29 Cave 29	
LATO SX		Fusello L/C 490mm	LATO DX	
NI 00138			NI 00139	

NOTE

Qashqai

1.5 DCI 81Kw

2014>



← →

LATO SX

NI 00142

RIFERIMENTI ORIGINALI

39101-4EA0A

39100-4EA0A



← →

NI 00143

LATO DX

NOTE

Qashqai

1.6 DCI 96Kw

2014>

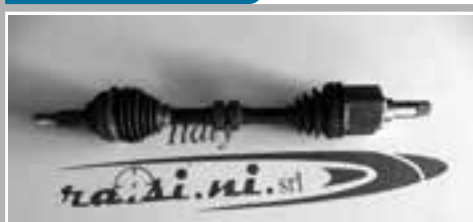

← →

LATO SX

NI 00144

RIFERIMENTI ORIGINALI

39101-4EB0A

39100-4EB0A



← →

NI 00145

LATO DX

NOTE

Qashqai

1.6 DCI 96Kw C/Autom.

2014>



← →

LATO SX

NI 00146

RIFERIMENTI ORIGINALI

39101-4EB2A

39100-4EB2A



← →

NI 00147

LATO DX

NOTE

Qashqai

1.6 DCI 96Kw 4x4

2014>



← →

LATO SX

NI 00148

RIFERIMENTI ORIGINALI

39101-4EB1A

39100-4EB1A



← →

NI 00149

LATO DX

NOTE

Qashqai 1.2 DIG-T 16v 85Kw			
RIFERIMENTI ORIGINALI			
←	39101-4ED0A	39100-4ED0A	→
←			→
LATO SX	NI 00150	NI 00151	LATO DX
NOTE			

X-Trail 2.2 DI 4x4 84Kw 2.2 DCI FWD 84Kw			2001> 01>03	2.2 DCI 100Kw 2.2 DCI 4x4 100Kw	2003> 2003>	2.5 4x4 121Kw	03>07
RIFERIMENTI ORIGINALI							
←	39101-8H710	39100-8H715	→				
←	Lungh. Tot. = 620 mm		→				
Cave 29			Cave 29				
LATO SX	NI 00152	NI 00153	LATO DX				
NOTE ABS 44							

X-Trail 2.0 DCI 110Kw 2.0 DCI FWD 110Kw			07>11 07>11	2.0 DCI 127Kw	07>11		
RIFERIMENTI ORIGINALI							
←	39101-JG74B	39100-JG74B	→				
←	Lungh. Tot. = 654 mm		→				
Cave 29			Cave 27				
LATO SX	NI 00154	NI 00155	LATO DX				
NOTE							

RIFERIMENTI ORIGINALI							
←			→				
←			→				
LATO SX			LATO DX				
NOTE							

Adam

1.2 16v 51Kw

2012>

RIFERIMENTI ORIGINALI

374826

374825

← Lungh. Tot. = 620 mm →
Cave 22 Cave 22← Lungh. Tot. = 922 mm →
Cave 22 Cave 22

LATO SX

OP 00184

OP 00185

LATO DX

NOTE

Agila

1.0 12V 43Kw
1.2 16v 59Kw

00>07

RIFERIMENTI ORIGINALI

4700644

4700645

← Lungh. Tot. = 605 mm →
Cave 23 Cave 22

A = ABS 43

A = ABS 43

← Lungh. Tot. = 854 mm →
Cave 22 Cave 23

LATO SX

OP 00151 - OP 00151/A

OP 00152 - OP 00152/A

LATO DX

NOTE ABS 43D su richiesta

Agila

1.0 12v 43Kw

00>07

RIFERIMENTI ORIGINALI

4701110

4701109

← Lungh. Tot. = 636 mm →
Cave 23 Cave 22

A = ABS 43

A = ABS 43

← Lungh. Tot. = 825 mm →
Cave 22 Cave 23

LATO SX

OP 00166 - OP 00166/A

OP 00167 - OP 00167/A

LATO DX

NOTE ABS 43D su richiesta

Agila

1.3 Cdti 51Kw

03>07

RIFERIMENTI ORIGINALI

4707440
92140134707439
9214011← Lungh. Tot. = 600 mm →
Cave 25 Cave 22

A = ABS 43

A = ABS 43

← Lungh. Tot. = 855 mm →
Cave 22 Cave 25

LATO SX

OP 00182

OP 00183

LATO DX

NOTE ABS 43D



Agila	1.0 48/50Kw 1.2 16v 63Kw	2007> 2008>		
	RIFERIMENTI ORIGINALI			
← Lungh. Tot. = 643 mm → Cave 25 Cave 22	4710017 93194655 4410251K00 441025K00	4710013 93194650 4410151K00 441015K00	Fusello L/C 67mm	Fusello L/C 67mm
LATO SX	OP 01005			LATO DX
				OP 01006
NOTE Fonico Ø 51				



Agila	1.3 CDTI 55Kw	2007>		
	RIFERIMENTI ORIGINALI			
← Lungh. Tot. = 631 mm → Cave 25 Cave 26	4711022	4710021		
LATO SX	OP 01090			LATO DX
				OP 01091
NOTE				



Antara	2.0 CDTI 93/110Kw Posteriori	06>11		
	RIFERIMENTI ORIGINALI			
← Lungh. Tot. = →	4804632	4804633		
LATO SX	OP 01021			LATO DX
				OP 01022
NOTE				



Antara	2.0 CDTI 93/110Kw 2.2 CDTI 120Kw	2007> 2010>	2.4 103/104/126Kw	2006>
	RIFERIMENTI ORIGINALI			
← Lungh. Tot. = 615 → Cave 30 Cave 27	4804567 96624721	4804568		
LATO SX	OP 01023			LATO DX
				OP 01024
NOTE				



Antara		2.2 CDTI 120/135Kw	2012>		
RIFERIMENTI ORIGINALI					
		4819361	4820448		
← Lungh. Tot. = → Cave 30				← Lungh. Tot. = → Cave 30	
LATO SX	OP 01092			OP 01093	LATO DX
NOTE					

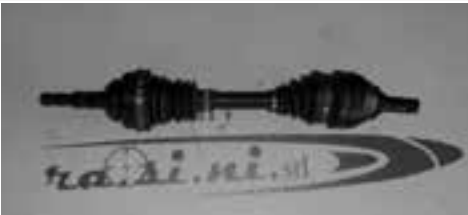

Astra F		1.7 TD-TDS 60Kw 1.8 l 16v 66Kw	91>98 2.0 l 85Kw 91>98	91>98	
RIFERIMENTI ORIGINALI					
		374183 374183* 90348324 90350824*	374184 90348325 90350907 90350907*		
← Lungh. Tot. = 590 mm → Cave 33 Cave 34		A = ABS 29	A = ABS 29	← Lungh. Tot. = 938 mm → Cave 34 Cave 33	
LATO SX	OP 00101 - OP 00101/A*			OP 00102 - OP 00102/A*	LATO DX
NOTE ABS 29D su richiesta					



Astra F		1.7 Diesel 42/44Kw	94>98		
RIFERIMENTI ORIGINALI					
		90350865	90350905		
← Lungh. Tot. = 590 mm → Cave 22 Cave 22		A = ABS 29	A = ABS 29	← Lungh. Tot. = 930 mm → Cave 22 Cave 22	
LATO SX	OP 00103 - OP 00103/A			OP 00104 - OP 00104/A	LATO DX
NOTE ABS 29D su richiesta					

Astra F		1.7 TD EcoTurbo 50Kw	94>98		
RIFERIMENTI ORIGINALI					
		374230	374229		
← Lungh. Tot. = 575 mm → Cave 22 Cave 22				← Lungh. Tot. = 940 mm → Cave 22 Cave 22	
LATO SX	OP 00105			OP 00106	LATO DX
NOTE					

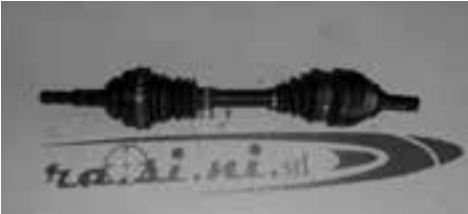
Astra F		1.7 D 42/44Kw	91>93		
 <p>← Lungh. Tot. = 590 mm → Cave 33 Cave 22</p> <p>LATO SX OP 00107 - OP 00107/A*</p>	RIFERIMENTI ORIGINALI		 <p>← Lungh. Tot. = 935 mm → Cave 22 Cave 33</p> <p>OP 00108 - OP 00108/A* LATO DX</p>	37410 374180 374180* 90348326 90350908 90350908*	374141 374178 374179* 90348327 90350909 90350909*
	A = ABS 29	A = ABS 29			
NOTE ABS 29D su richiesta					

Astra F		1.4 I 44/60Kw 1.6 I 16v 55/74Kw	91>94 91>94	1.4 I 16v 66Kw 1.6 52Kw	91>01 94>96	1.7 TD 50/60Kw	91>98
 <p>← Lungh. Tot. = 585 mm → Cave 22 Cave 22</p> <p>LATO SX OP 00109 - OP 00109/A*</p>	RIFERIMENTI ORIGINALI		 <p>← Lungh. Tot. = 930 mm → Cave 22 Cave 22</p> <p>OP 00110 - OP 00110/A* LATO DX</p>	374178 90350865 90350865*	374188 374210 90348317 90350905		
	A = ABS 29	A = ABS 29					
NOTE ABS 29D su richiesta							

Astra G		1.2 16v 48/55Kw 1.4 16v 55/66Kw	98>04 1998>	1.6 55/62Kw 1.6 16v 74Kw	1998> 1998>	1.7 CDTI 59Kw	98>00
 <p>← Lungh. Tot. = 595 mm → Cave 33 Cave 22</p> <p>LATO SX OP 00162</p>	RIFERIMENTI ORIGINALI		 <p>← Lungh. Tot. = 960 mm → Cave 22 Cave 33</p> <p>OP 00163 LATO DX</p>	374321	374322 374769 90538603		
	NOTE Fonico Ø 52						

Astra G		2.0 DI 60Kw 2.0 DTI 74Kw	98>05 99>05	2.2 16v 108Kw 2.2 DTI 108Kw	02>05 01>04	
 <p>← Lungh. Tot. = 595 mm → Cave 33 Cave 34</p> <p>LATO SX OP 00113</p>	RIFERIMENTI ORIGINALI		 <p>← Lungh. Tot. = 955 mm → Cave 34 Cave 33</p> <p>OP 00114 LATO DX</p>	90538604	90538605	
	NOTE ABS 29D					

Astra G

1.7 DTI 16v 55Kw
1.8 16v 81/85/92Kw2000> | 2.2 16v 92Kw
1998>

RIFERIMENTI ORIGINALI

374321
90539771374769
90539783← Lungh. Tot. = 600 mm →
Cave 33 Cave 22

LATO SX

OP 00111

← Lungh. Tot. = 960 mm →
Cave 22 Cave 33

OP 00112

LATO DX

NOTE ABS 29D

Astra G

2.2 DTI 92Kw

02>05

RIFERIMENTI ORIGINALI

374455

374456

← Lungh. Tot. = 590 mm →
Cave 33 Cave 27

LATO SX

OP 00170

Fonico Ø 56

← Lungh. Tot. = 625 mm →
Cave 27 Cave 33

OP 00171

LATO DX

NOTE

Astra G

2.0 PC 141/147Kw
2.0 16V 140/141/147Kw

01>05

RIFERIMENTI ORIGINALI

374397

374106

← Lungh. Tot. = 593 mm →
Cave 33 Cave 34

LATO SX

OP 00135

← Lungh. Tot. = 668 mm →
Cave 34 Cave 33

OP 00136

LATO DX

NOTE

Astra H

1.2 16v 59Kw
1.4 66Kw05>09 | 1.6 77/85Kw
2004>

2004>

RIFERIMENTI ORIGINALI

13136379
374545374548
374601← Lungh. Tot. = 590 mm →
Cave 33 Cave 22

LATO SX



OP 01007



← Lungh. Tot. = 952 mm →
Cave 22 Cave 33



OP 01008



LATO DX

NOTE Fonico Ø 52

Astra H		1.3 CDTI 66Kw	2004>		
 <p>← Lungh. Tot. = 575 mm → Cave 33 Cave 25</p> <p>LATO SX OP 00180</p>	RIFERIMENTI ORIGINALI		 <p>← Lungh. Tot. = 570 mm → Cave Int. 34 Cave 33</p> <p>OP 00181 LATO DX</p>	24462244	13189073 374600
	NOTE Fonico Ø 52				

Astra H		1.7 CDTI 74Kw	04>09		
 <p>← Lungh. Tot. = 592 mm → Cave 33 Cave 34</p> <p>LATO SX OP 00168</p>	RIFERIMENTI ORIGINALI		 <p>← Lungh. Tot. = 560 mm → Cave Int. 34 Cave 33</p> <p>OP 00169 LATO DX</p>	374543	374544
	NOTE Fonico Ø 53				

Astra H		1.7 CDTI 59Kw 1.8 92Kw	2004> 2004>	1.8 103Kw	2006>
 <p>← Lungh. Tot. = 590 mm → Cave 33 Cave 22</p> <p>LATO SX OP 01009</p>	RIFERIMENTI ORIGINALI		 <p>← Lungh. Tot. = 950 mm → Cave 22 Cave 33</p> <p>OP 01010 LATO DX</p>	374547	374546 374591
	NOTE Fonico Ø 53				

Astra H		1.9 CDTI 110Kw 2.0 Turbo GTC 177Kw	04>06 05>11		
 <p>← Lungh. Tot. = 576 mm → Cave 30 Cave 25</p> <p>LATO SX OP 00195</p>	RIFERIMENTI ORIGINALI		 <p>← Lungh. Tot. = 592 mm → Cave Int. 34 Cave 30</p> <p>OP 00196 LATO DX</p>	374561	374562 374812
	NOTE Fonico Ø 54				

Astra H

1.9 CDTI 74/88/103Kw

2004>



← Lungh. Tot. = 576 mm →
Cave 33 Cave 25

LATO SX

OP 00199

RIFERIMENTI ORIGINALI

374551

374552
24462250

← Lungh. Tot. = 594 mm →
Cave Int. 34 Cave 33

OP 01001

LATO DX

NOTE Fonico Ø 52

Astra H

2.0 16v 125/147kW

2004>



← Lungh. Tot. = 610 mm →
Cave 30 Cave 34

LATO SX

OP 00164

RIFERIMENTI ORIGINALI

374805

374806



← Lungh. Tot. = 590 mm →
Cave Int. 34 Cave 30

OP 00165

LATO DX

NOTE Fonico Ø 54 - * dal telaio 72000001 - ** dal telaio 72025242

Astra H

1.7 CDTI 81/92Kw

07>12



← Lungh. Tot. = 580 mm →
Cave 33 Cave 25

LATO SX

OP 01102

RIFERIMENTI ORIGINALI

374641
13214836

374642



← Lungh. Tot. = 564 mm →
Cave Int. 34 Cave 33

OP 01103

LATO DX

NOTE Fonico Ø 53

Astra J

1.3 CTDI 70Kw
1.4 88/103Kw

12/09> 1.6 85Kw



← Lungh. Tot. = 595 mm →
Cave 33 Cave 25

LATO SX

OP 01025

RIFERIMENTI ORIGINALI

13321163
374687374904
13335161

← Lungh. Tot. = 590 mm →
Cave 34 Cave 33

OP 01026

LATO DX

NOTE

Astra J 1.7 CDTI 74/81/92/96Kw 12/09>		
	RIFERIMENTI ORIGINALI 13335135 374885 374502 13271555	
← Lungh. Tot. = 610 mm → Cave 30 Cave 25		← Lungh. Tot. = 590 mm → Cave Int. 34 Cave 30
LATO SX OP 01017		OP 01018 LATO DX
NOTE		

Astra J 1.7 CDTI 74/81/92/96Kw 2010>		
	RIFERIMENTI ORIGINALI 5374054 13396740	
← Lungh. Tot. = 580 mm → Cave 30 Cave 25		← Lungh. Tot. = 590 mm → Cave interna 34 Cave 30
LATO SX OP 01030		OP 01031 LATO DX
NOTE Fino al telaio C1033260		

Astra J 1.4 64/74Kw 2010> 1.6 LPG 84/85Kw 2010>		
1.6 85Kw		
	RIFERIMENTI ORIGINALI 13250860	
← Lungh. Tot. = 618 mm → Cave 33 Cave 22	374487 13250861	← Lungh. Tot. = 985 mm → Cave 22 Cave 33
LATO SX OP 01034		OP 01035 LATO DX
NOTE		

Astra J 2.0 CDTI 118/121Kw 12/09>		
	RIFERIMENTI ORIGINALI 374599 374892 13250869	
← Lungh. Tot. = 600 → Cave 30 Cave 27		← Lungh. Tot. = 600 → 27 Cave 30
LATO SX OP 01019		OP 01020 LATO DX
NOTE Fino al telaio C1033260		

Astra J

1.6 CDTI 81/100Kw
1.6 SIDI 125Kw2014
2012>

RIFERIMENTI ORIGINALI

374885

374886

← Lungh. Tot. = 595 →
30 25

LATO SX

OP 01100

← Lungh. Tot. = 590 →
Cave Int.34 Cave 30

OP 01101

LATO DX

NOTE

Calibra

2.0 I 85Kw
2.0 16v 100/110Kw1989> | 2.0 I 16v 4x4 100/110Kw
1989> | 2.0 I 16v TB 4x4 150Kw1989> | 2.0 I 4x4 85Kw
1989>

1989>

RIFERIMENTI ORIGINALI

374145

374186

← Lungh. Tot. = 590 mm →
Cave 33 Cave 34

LATO SX

OP 00115

← Lungh. Tot. = 653 mm →
Cave 34 Cave 33

OP 00116

LATO DX

NOTE ABS 43

Calibra

2.0 85Kw
2.0 I 16v 100/110Kw89>98 | 2.0 I 16v 4x4 100/110Kw
89>98 | 2.0 I 4x4 85Kw89>98 | 2.0 I 16v TB 4x4 150Kw
89>98

89>98

RIFERIMENTI ORIGINALI

374183

374185

← Lungh. Tot. = 590 mm →
Cave 33 Cave 34

LATO SX

OP 00117

← Lungh. Tot. = 653 mm →
Cave Int. 34 Cave 33

OP 00118

LATO DX

NOTE ABS 29

Combo

1.2 33Kw
1.4 I 44/60Kw94>01 | 1.7 D 42Kw
94>01

94>01

RIFERIMENTI ORIGINALI

374222*

374221*

← Lungh. Tot. = 585 mm →
Cave 22 Cave 22

LATO SX

OP 00174 - OP 00174/A*

A = ABS 29



A = ABS 29

← Lungh. Tot. = 930 mm →
Cave 22 Cave 22



OP 00175 - OP 00175/A*

LATO DX



NOTE

Combo		1.7 D 48Kw 1.7 TD 55Kw	2001> 2001>		
RIFERIMENTI ORIGINALI					
 <p>← Lungh. Tot. = 585 mm → Cave 22 Cave 22</p> <p>LATO SX OP 00176 - OP 00176/A</p>	374466	374468	 <p>← Lungh. Tot. = 930 mm → Cave 22 Cave 22</p> <p>OP 00177 - OP 00177/A LATO DX</p>		
	A = ABS 29	A = ABS 29			



NOTE

Combo C		1.7 55Kw 2001>			
RIFERIMENTI ORIGINALI					
 <p>← Lungh. Tot. = 585 mm → Cave 22 Cave 22</p> <p>LATO SX OP 00121 - OP 00121/A</p>	374371* 3744442 24427062	374370*	 <p>← Lungh. Tot. = 930 mm → Cave 22 Cave 22</p> <p>OP 00122 - OP 00122/A LATO DX</p>		
	A = ABS 29	A = ABS 29			



NOTE ABS 29D su richiesta

Corsa A		1.0 33/35Kw 1.2 33/40Kw	82>92 82>92	1.3 44/51Kw 1.4 53/55Kw	82>92 82>92	1.5 D 37Kw	92>93
RIFERIMENTI ORIGINALI							
 <p>← Lungh. Tot. = 540 mm → Cave 22 Cave 22</p> <p>LATO SX OP 00153</p>	374077	374078 7837457	 <p>← Lungh. Tot. = 880 mm → Cave 22 Cave 22</p> <p>OP 00154 LATO DX</p>				



NOTE

Corsa A		1.5 TD 49Kw 1.6 GSI 72/74Kw	87>92 87>92	1.6 I 74Kw	87>92	
RIFERIMENTI ORIGINALI						
 <p>← Lungh. Tot. = 540 mm → Cave 22 Cave 22</p> <p>LATO SX OP 00155</p>	374223	374224	 <p>← Lungh. Tot. = 880 mm → Cave 22 Cave 22</p> <p>OP 00156 LATO DX</p>			



NOTE

Corsa B		1.6 GSI 16v 80Kw 1.6 I 16v 78Kw	93>00 94>00		
		RIFERIMENTI ORIGINALI			
← Lungh. Tot. = 585 mm → Cave 22 Cave 22		374222*	374221*	← Lungh. Tot. = 930 mm → Cave 22 Cave 22	
LATO SX OP 00174 - OP 00174/A*		A = ABS 29	A = ABS 29	OP 00175 - OP 00175/A* LATO DX	



NOTE ABS 29D su richiesta

Corsa B		1.2 16v 48Kw 1.2 I 33Kw	98>00 93>00	1.4 16v 66Kw 1.4 I 44Kw	94>00 93>00	1.4 SI 60Kw 1.5 D 37Kw	93>00 93>00	1.5 TD 49Kw 1.7 D 44Kw	93>00 96>00
		RIFERIMENTI ORIGINALI							
← Lungh. Tot. = 585 mm → Cave 22 Cave 22		374222*	374221*	← Lungh. Tot. = 930 mm → Cave 22 Cave 22					
LATO SX OP 00174 - OP 00174/A*		A = ABS 29	A = ABS 29	OP 00175 - OP 00175/A* LATO DX					

NOTE ABS 29D su richiesta

Corsa B		1.0 3 Cyl. 12v 40Kw	96>00		
		RIFERIMENTI ORIGINALI			
← Lungh. Tot. = 562 mm → Cave 22 Cave 22		374042* 374046* 374366	374041* 374048* 374312	← Lungh. Tot. = 910 mm → Cave 22 Cave 22	
LATO SX OP 00119 - OP 00119/A*		A = ABS 29	A = ABS 29	OP 00120 - OP 00120/A* LATO DX	

NOTE ABS 29D su richiesta

Corsa C		1.0 12v 43Kw 1.2 16v	00>03 00>03		
		RIFERIMENTI ORIGINALI			
← Lungh. Tot. = 585 mm → Cave 22 Cave 22		374371* 3744442 24427062	374370*	← Lungh. Tot. = 930 mm → Cave 22 Cave 22	
LATO SX OP 00121 - OP 00121/A		A = ABS 29	A = ABS 29	OP 00122 - OP 00122/A LATO DX	

NOTE ABS 29D su richiesta

Corsa C	1.3 CDTI 51Kw 1.4 16v 66Kw	2003> 1.7 D 48kw 2000> 1.7 TD 55Kw	2000> 2000>
	RIFERIMENTI ORIGINALI		
← Lungh. Tot. = 585 mm → Cave 22 Cave 22	374466	374468	← Lungh. Tot. = 930 mm → Cave 22 Cave 22
LATO SX OP 00176 - OP 00176/A			OP 00177 - OP 00177/A LATO DX
NOTE ABS 29D su richiesta			

Corsa D	1.2 54Kw	2006>	
	RIFERIMENTI ORIGINALI		
← Lungh. Tot. = 620 mm → Cave 22 Cave 22	374826	374825	← Lungh. Tot. = 922 mm → Cave 22 Cave 22
LATO SX OP 00184			OP 00185 LATO DX
NOTE Fonico Ø 51			

Corsa D	1.2 57/59Kw 1.4 16v 64/66/74Kw		
	RIFERIMENTI ORIGINALI		
← Lungh. Tot. = 615 mm → Cave 22 Cave 22	374633 374789 13149830	374788 13149829	← Lungh. Tot. = 915 mm → Cave 22 Cave 22
LATO SX OP 01015			OP 01016 LATO DX
NOTE			

Corsa D	1.3 CDTI 55Kw	2006>	
	RIFERIMENTI ORIGINALI		
← Lungh. Tot. = 615 mm → Cave 25 Cave 22	374792	13150503 374793	← Lungh. Tot. = 918 mm → Cave 22 Cave 25
LATO SX OP 00191			OP 00192 LATO DX
NOTE Fonico Ø 51			

Corsa D

1.3 CDTI 66Kw

2006>



← Lungh. Tot. = 579 mm →
Cave 25 Cave 25

LATO SX

OP 00186

RIFERIMENTI ORIGINALI

374791

374790



← Lungh. Tot. = 955 mm →
Cave 25 Cave 25

OP 00187

LATO DX

NOTE Fonico Ø 51

Corsa E

1.3 CDTI 55/70Kw

2010>



← Lungh. Tot. = 605 mm →
Cave 25 Cave 22

LATO SX

OP 01032

RIFERIMENTI ORIGINALI

5374193
5374141
13486866



← Lungh. Tot. = →
Cave 22 Cave 25

OP 01033

LATO DX

NOTE Ø 51

Insignia

2.0 CDTI 81/96Kw

07/08>09



← Lungh. Tot. = 627 mm →
Cave 30 Cave 25

LATO SX

OP 01011

RIFERIMENTI ORIGINALI

13228204
374835

374829
374922
13219092
133448258

Fusello L/C 93,8mm

Fusello L/C 93,8mm

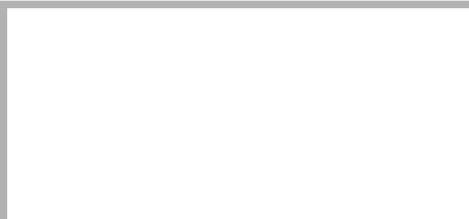

← Lungh. Tot. = 616 →
Cave 27 Cave 30

OP 01013

LATO DX

NOTE Fonico Ø 53

Insignia

2.0 CDTI 118Kw
2.0 CDTI 140Kw07/08>
07/08>

2.0 CDTI 120Kw

2013>



← Lungh. Tot. = 620 mm →
Cave 30 Cave 27

LATO SX

OP 01013

RIFERIMENTI ORIGINALI

13219092
13348258
374829
374922





← Lungh. Tot. = 620 mm →
Cave 27 Cave 30



OP 01013

LATO DX



NOTE

Insignia	2.0 CDTI 118Kw c/aut 2.0 CDTI 140Kw c/aut	07/08> 07/08>	2.0 CDTI 81/96/118Kw	2008>
	RIFERIMENTI ORIGINALI			
← Lungh. Tot. = 618 mm → Cave 30 Cave 27	13228199 374832		371832 374930	← Lungh. Tot. = 618 mm → Cave 27 Cave 30
LATO SX	OP 01014		OP 01014	
LATO DX				



NOTE

Kadett E	1.2 40Kw 1.3 144Kw	84>93 84>93	1.4 44Kw 1.6 55Kw	90>93 90>93
	RIFERIMENTI ORIGINALI			
← Lungh. Tot. = 575 mm → Cave 22 Cave 22	374165* 90095478 90157133		374164* 90121913 90157134	← Lungh. Tot. = 918 mm → Cave 22 Cave 22
LATO SX	OP 00125 - OP 00125/A*		OP 00126 - OP 00126/A*	
LATO DX				



NOTE ABS 29D su richiesta



Kadett E	1.6 60Kw 1.6 D 40Kw	84>86 84>86	1.7 D 42Kw 1.8 62/85Kw	84>89 84>91	2.0 85Kw 2.0 16v 110Kw	84>91 84>91	2.0 GSI 85/89Kw	84>91
	RIFERIMENTI ORIGINALI							
← Lungh. Tot. = 585 mm → Cave 33 Cave 34	374105 374122 374172		374098 374173 374174	← Lungh. Tot. = 925 mm → Cave 34 Cave 33				
LATO SX	OP 00127 - /A - /B		OP 00128 - /A - /B					
LATO DX								

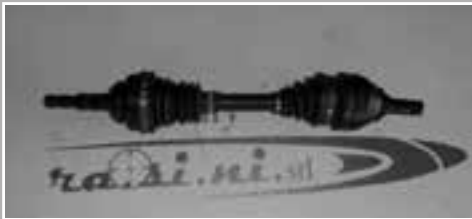

NOTE



Kadett E	1.5 TD Isuzu 53Kw	88>91		
	RIFERIMENTI ORIGINALI			
← Lungh. Tot. = 582 mm → Cave 33 Cave 34	90121881 90199428 90216108			← Lungh. Tot. = 642 mm → Cave Int. 34 Cave 33
LATO SX	OP 00129		OP 00130	
LATO DX				

NOTE

Kadett E		1.5 TD 1.6 D	87>91 1.7 D 87>91	87>91
	RIFERIMENTI ORIGINALI			
← Lungh. Tot. = 585 mm → Cave 33 Cave 22	B = ABS 43	B = ABS 43	← Lungh. Tot. = 950 mm → Cave 22 Cave 33	
LATO SX OP 00131 - OP 00131/B			OP 00132 - OP 00132/B	LATO DX
NOTE				

Meriva		1.4 16v 66Kw 1.6 16v 77Kw	04>10 03>10	
	RIFERIMENTI ORIGINALI			
← Lungh. Tot. = 580 mm → Cave 22 Cave 22	374466	374468	← Lungh. Tot. = 935 mm → Cave 22 Cave 22	
LATO SX OP 00188			OP 00189	LATO DX
NOTE ABS 29D				

Meriva		1.7 CDTI 74Kw	03>10	
	RIFERIMENTI ORIGINALI			
← Lungh. Tot. = 600 mm → Cave 33 Cave 34	374524	374525 13159534	← Lungh. Tot. = 620 mm → Cave Int. 34 Cave 33	
LATO SX OP 00178			OP 00179	LATO DX
NOTE ABS 29D				

Meriva		1.3 CDTI 1.7 DTI 48/55Kw	05>10 03>10	
	RIFERIMENTI ORIGINALI			
← Lungh. Tot. = 592 mm → Cave 22 Cave 22	374513	374512 374510 26111119	← Lungh. Tot. = 940 mm → Cave 22 Cave 22	
LATO SX OP 00172			OP 00173	LATO DX
NOTE ABS 29D				

Meriva 1.7 CDTI 92Kw 2007>		RIFERIMENTI ORIGINALI	
	374619	374525 374526	
← Lungh. Tot. = 575 mm → Cave 33 Cave 25			← Lungh. Tot. = 620 mm → Cave Int 34 Cave 33
LATO SX OP 01096			OP 01097 LATO DX
NOTE			

Meriva 1.7 CDTI C/A 96Kw 2012>		RIFERIMENTI ORIGINALI	
	374875 1324864D	374876 13248646	
← Lungh. Tot. = 585 mm → Cave 33 Cave 25			← →
LATO SX OP 01094			OP 01095 LATO DX
NOTE Fonico Ø 52			

Mokka 1.7 CTDI 96Kw 2012		RIFERIMENTI ORIGINALI	
	5374160 94560844	5374156 94560848	
← →			← Lungh. Tot. = 590mm → 34 25
LATO SX			LATO DX
NOTE			

Movano 2.5 D 59Kw 2.8 DTI 84Kw 98>00 1998>		RIFERIMENTI ORIGINALI	
	7700102978* 7700102979	7700102980* 7700102981 7711135280	
← Lungh. Tot. = 670 mm → Cave 28 Rullo Ø 37	A = ABS 51	Fusello L/C 435 m A = ABS 51	← Lungh. Tot. = 1120 mm → Cave 39 Cave 28
LATO SX RE 01183 - RE 01183/A*			RE 00184 - RE 00184/A* LATO DX
NOTE			

Movano

2.2 DTI 66Kw

2001>



← Lungh. Tot. = 665 mm →
Cave 28 Rullo Ø 37

LATO SX **RE 00185 - RE 00185/A**

RIFERIMENTI ORIGINALI

7700102979
7711135278
7711135279
8200485576*

A = ABS 51

7701473014
7711135531*
8200026912
8200169277
8200169279*

Fusello L/C 421 m
A = ABS 51



← Lungh. Tot. = 1125 mm →
Cave 39 Cave 28

RE 00186 - RE00186/A LATO DX**NOTE** ABS 51D su richiesta

Movano

1.9 DTI 59Kw

2000>



← Lungh. Tot. = 645 mm →
Cave 28 Rullo Ø 37

LATO SX **RE 01170 - RE 01170/A**

RIFERIMENTI ORIGINALI

8200052421

A = ABS 51

7701473013
8200052423

Fusello L/C 390 m
A = ABS 51



← Lungh. Tot. = 1155 mm →
Cave 39 Cave 28

RE 00195 - RE 00195/A LATO DX**NOTE**

Movano

2.5 CDTI 88Kw

2007>



← Lungh. Tot. = 701 mm →
Cave 28 Cave 39

LATO SX **RE 01193**

RIFERIMENTI ORIGINALI

4417083
4421271
93189873
95507091

8200414937

Fusello L/C 421 m

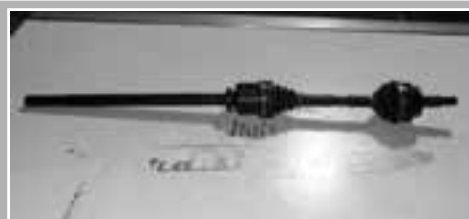

← Lungh. Tot. = 1115 mm →
Cave 39 Cave 28

RE 01194 LATO DX**NOTE** ABS 51D

Movano

3.0 DTI 100Kw

2003>



← Lungh. Tot. = 690 mm →
Cave 28 Cave 39

LATO SX **RE 01150**

RIFERIMENTI ORIGINALI

8200299844

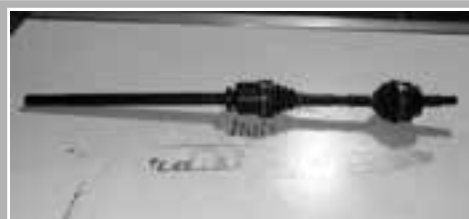

8200164149

Fusello L/C 549





← Lungh. Tot. = 1130 mm →
Cave 39 Cave 28



RE 01151 LATO DX**NOTE** ABS 51D

Signum	2.0 16v T 129Kw 2.2 DTI 92Kw	2003> 3.0 DTI 130Kw 2003> 3.2 V6 155Kw	2003>
	RIFERIMENTI ORIGINALI		
← Lungh. Tot. = 612 mm → Cave 30 Cave 27	374470		← Lungh. Tot. = 612 mm → Cave 27 Cave 30
LATO SX OP 00190			OP 00190 LATO DX



NOTE

Tigra	1.4 16v 66Kw	1994>	
	RIFERIMENTI ORIGINALI		
← Lungh. Tot. = 585 mm → Cave 22 Cave 22	374222 A = ABS 29	374221 A = ABS 29	← Lungh. Tot. = 930 mm → Cave 22 Cave 22
LATO SX OP 00174 - OP 00174/A			OP 00175 - OP 00175/A LATO DX



NOTE

Tigra	1.6 16v 78Kw	1994>	
	RIFERIMENTI ORIGINALI		
← Lungh. Tot. = 605 mm → Cave 22 Cave 22	374259 A = ABS 29	374260 A = ABS 29	← Lungh. Tot. = 940 mm → Cave 22 Cave 22
LATO SX OP 00133 - OP 00133/A			OP 00134 - OP 00134/A LATO DX



NOTE ABS 29D su richiesta

Tigra	1.4 16v- 1.8 16v 1.3 Cdti	06/2004> 06/2004>	
	RIFERIMENTI ORIGINALI		
← Lungh. Tot. = 585 mm → Cave 22 Cave 22	374466 A = ABS 29	374468 A = ABS 29	← Lungh. Tot. = 930 mm → Cave 22 Cave 22
LATO SX OP 00176/A			OP 00177/A LATO DX



NOTE

Vectra A		1.4 S 55Kw 1.6 60Kw	88>93 1.6 55Kw 88>93	
 <p>← Lungh. Tot. = 585 mm → Cave 22 Cave 22</p> <p>LATO SX OP 00137 - /A - /B</p>	RIFERIMENTI ORIGINALI		 <p>← Lungh. Tot. = 928 mm → Cave 22 Cave 22</p> <p>OP 00138 - /A - /B LATO DX</p>	
	90350865 90348316/B	90350905 90348317/B		
	A = ABS 29 B = ABS 43	A = ABS 29 B = ABS 43		



NOTE ABS 29-43D su richiesta

Vectra A		1.7 D 42/44Kw 1.7 TD 60Kw	88>93 1.8 16v 66Kw 88>93 2.0 110Kw	88>93 2.0 74/95Kw 88>93	88>93
 <p>← Lungh. Tot. = 590 mm → Cave 33 Cave 34</p> <p>LATO SX OP 00143 - /A - /B</p>	RIFERIMENTI ORIGINALI		 <p>← Lungh. Tot. = 938 mm → Cave 34 Cave 33</p> <p>OP 00144 - /A - /B LATO DX</p>		
	90350824/A 90348324/B	90350907/A 90348325/B			
	A = ABS 29 B = ABS 43	A = ABS 29 B = ABS 43			



NOTE ABS 29-43D su richiesta

Vectra A		2.0 16v 100Kw 2.0 16v 4x4 110Kw	89>93 2.0 TB 4x4 150Kw 89>93	89>93
 <p>← Lungh. Tot. = 590 mm → Cave 33 Cave 34</p> <p>LATO SX OP 00143 - /A - /B</p>	RIFERIMENTI ORIGINALI		 <p>← Lungh. Tot. = 653 mm → Cave Int. 34 Cave 33</p> <p>OP 00146 - /A - /B LATO DX</p>	
	90350824/A 90348324/B	90350910/A 433746/B		
	A = ABS 29 B = ABS 43	A = ABS 29 B = ABS 43		

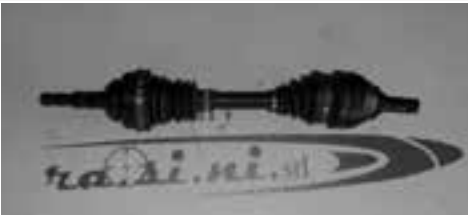

NOTE ABS 29-43D su richiesta

Vectra B		1.6 55Kw 1.6 16v 74Kw	95>99 95>99	
 <p>← Lungh. Tot. = 593 mm → Cave 22 Cave 22</p> <p>LATO SX OP 00193 - OP 00193/A*</p>	RIFERIMENTI ORIGINALI		 <p>← Lungh. Tot. = 957 mm → Cave 22 Cave 22</p> <p>OP 00194 - OP 00194/A* LATO DX</p>	
	90511447* 90512304	374250 374252*		
	A = ABS 29	A = ABS 29		



NOTE ABS 29D su richiesta

Vectra B		1.6 55Kw 1.6 16v 74Kw	99>02 99>02	
	RIFERIMENTI ORIGINALI			
	90511447	374252		
← Lungh. Tot. = 597 mm → Cave 33 Cave 22			← Lungh. Tot. = 960 mm → Cave 22 Cave 33	
LATO SX	OP 01002		OP 01003	LATO DX



NOTE ABS 29D

Vectra B		1.6 60Kw 1.6 D 40Kw 1.7 TD 60Kw 1.8 16v 85/92Kw	84>86 84>86 95>96 95>02	1.7 D 42Kw 1.8 62/85Kw 2.0 16v DI 60Kw 2.0 I 82Kw	84>89 84>91 95>02 95>02	2.0 85Kw 2.0 16v 110Kw 2.0 I 16v 100Kw 2.5 V6 125Kw	84>91 84>91 95>02 95>00	2.0 GSI 85/89Kw 2.0 74Kw	84>91 95>00
	RIFERIMENTI ORIGINALI								
	374249 374261 90498637 90511447	90496976 90512993							
← Lungh. Tot. = 595 mm → Cave 33 Cave 34			← Lungh. Tot. = 962 mm → Cave 34 Cave 33						
LATO SX	OP 00147		OP 00148	LATO DX					

NOTE ABS 29D

Vectra B		2.2 DTI 92Kw	00>02	
	RIFERIMENTI ORIGINALI			
	374385	374386		
← Lungh. Tot. = 585 mm → Cave 33 Cave 27			← Lungh. Tot. = 624 mm → Cave 27 Cave 33	
LATO SX	OP 00197		OP 00198	LATO DX

NOTE ABS 29D

Vectra C		2.0 T 16v 129Kw 2.2 DTI 92Kw	2003> 2002>	3.0 DTI 130Kw 3.2 V6 155Kw	2003> 2002>
	RIFERIMENTI ORIGINALI				
	13166590 374470 374536 374537				
← Lungh. Tot. = 612 mm → Cave 30 Cave 27			← Lungh. Tot. = 612 mm → Cave 27 Cave 30		
LATO SX	OP 00190		OP 00190	LATO DX	

NOTE Fonico Ø 54

Vectra C

2.0 DTI 16v
2.2 16v04/02>
08/02>13← Lungh. Tot. = 630 mm →
Cave 30 Cave 34

LATO SX

OP 01098

RIFERIMENTI ORIGINALI

374471

374535

← Lungh. Tot. = 590 mm →
Cave Int. 34 Cave 30

OP 01099

LATO DX

NOTE

Vivaro

1.9 DI 60Kw
1.9 DTI 74Kw2001> | 2.0 16v 88Kw
2001>

2001>

← Lungh. Tot. = 670 mm →
Cave 27 Rullo Ø 37

LATO SX

RE 00168

RIFERIMENTI ORIGINALI

4414517
4430547
4409210
911667084414516
91166707
4409208

Fusello L/C 363mm

← Lungh. Tot. = 1018 mm →
Cave 39 Cave 27

RE 00169

LATO DX

NOTE Fonico Ø 56,4

Vivaro

2.5 CDTI 84/99/107Kw

2006>

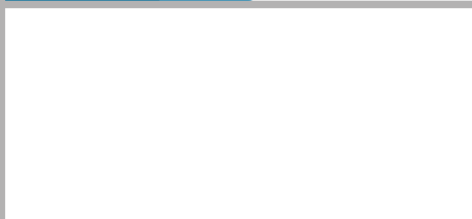
← Lungh. Tot. = 670 mm →
Cave 27 Cave 39

LATO SX

RF 01210

RIFERIMENTI ORIGINALI

93856309
93861972

8200452273

Fusello L/C 430mm

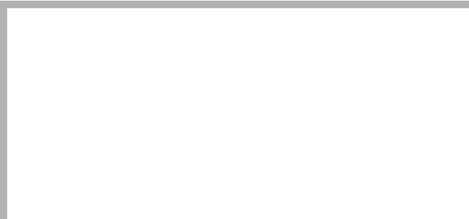
← Lungh. Tot. = 1045 mm →
Cave 39 Cave 27

RF 01211

LATO DX

NOTE 27/36

Vivaro

2.5 DTI 99Kw

2003>

← Lungh. Tot. = 635 mm →
Cave 27 Rullo Ø 37

LATO SX

RE 01195

RIFERIMENTI ORIGINALI

4411699
8200169164
8200485590

4411698



Fusello L/C 409mm



← Lungh. Tot. = 1058 mm →
Cave 39 Cave 27

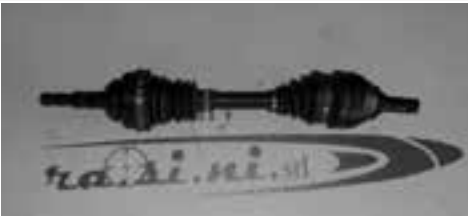

RE 01196

LATO DX

NOTE

Zafira A		1.6 74Kw 1.8 85/92Kw	1999> 1999>		
 <p>← Lungh. Tot. = 596 mm → Cave 33 Cave 22</p> <p>LATO SX OP 00149</p>	RIFERIMENTI ORIGINALI		 <p>← Lungh. Tot. = 955 mm → Cave 22 Cave 33</p> <p>OP 00150 LATO DX</p>	374321	90538603
	NOTE Fonico Ø 52				

Zafira A		2.0 DI 16v 60Kw 2.0 DTI 74Kw	1999> 1999>	2.0 16v 108Kw	1999>
 <p>← Lungh. Tot. = 596 mm → Cave 33 Cave 34</p> <p>LATO SX OP 00160</p>	RIFERIMENTI ORIGINALI		 <p>← Lungh. Tot. = 955 mm → Cave 34 Cave 33</p> <p>OP 00161 LATO DX</p>	90538604	90538605
	NOTE Fonico Ø 52				

Zafira A		2.2 16v DTI 92Kw	2002>		
 <p>← Lungh. Tot. = 590 mm → Cave 33 Cave 27</p> <p>LATO SX OP 00170</p>	RIFERIMENTI ORIGINALI		 <p>← Lungh. Tot. = 625 mm → Cave 27 Cave 33</p> <p>OP 00171 LATO DX</p>	374455	364456
	NOTE Fonico Ø 56				

Zafira B		1.6 77/85Kw	07/05>		
 <p>← Lungh. Tot. = 590 mm → Cave 33 Cave 22</p> <p>LATO SX OP 01007</p>	RIFERIMENTI ORIGINALI		 <p>← Lungh. Tot. = 952 mm → Cave 22 Cave 33</p> <p>OP 01008 LATO DX</p>	374321 90539771	90538603
	NOTE Fonico Ø 52				

Zafira B

1.7 CDTI 91Kw

01/08>



← Lungh. Tot. = 595 mm →
Cave 33 Cave 34

LATO SX

OP 00168

RIFERIMENTI ORIGINALI

374543

374544



← Lungh. Tot. = 560 mm →
Cave Int. 34 Cave 33

OP 00169

LATO DX

NOTE Fonico Ø 53

Zafira B

1.7 CDTI 81Kw
1.8 103Kw01/08>
07/05>

← Lungh. Tot. = 587 mm →
Cave 33 Cave 22

LATO SX

OP 01009

RIFERIMENTI ORIGINALI

374547

374591



← Lungh. Tot. = 950 mm →
Cave 22 Cave 33

OP 01010

LATO DX

NOTE Fonico Ø 53

Zafira B

1.9 CDTI 110Kw

07/05>



← Lungh. Tot. = 576 mm →
Cave 30 Cave 25

LATO SX

OP 00195

RIFERIMENTI ORIGINALI

374561

374562



← Lungh. Tot. = 592 mm →
Cave Int. 34 Cave 30

OP 00196

LATO DX

NOTE Fonico Ø 54

Zafira B

1.9 CDTI 88Kw
1.9 CDTI 74Kw07/05>
07/05>

← Lungh. Tot. = 576 mm →
Cave 33 Cave 25

LATO SX

OP 00199

RIFERIMENTI ORIGINALI

374551



374552
24462250

← Lungh. Tot. = 594 mm →
Cave Int. 34 Cave 33



OP 01001

LATO DX



NOTE Fonico Ø 52

104	Tutti i modelli	72>88	
 ← Lungh. Tot. = 683 mm → Cave 21 Cave 22	RIFERIMENTI ORIGINALI		 ← Lungh. Tot. = 683 mm → Cave 22 Cave 21
	327453 327461 95582409		
LATO SX	PE 00191		PE 00191 LATO DX



NOTE

106	1.0 33/37Kw 1.1 40Kw	91>96 91>96	
 ← Lungh. Tot. = 617 mm → Cave 21 Cave 22	RIFERIMENTI ORIGINALI		 ← Lungh. Tot. = 800 mm → Cave 22 Cave 21
	95648547 96033355 96042491 96601868	95601867 95601887 96033369 96042942	
LATO SX	CI 00101		CI 00102 LATO DX



NOTE Cercio 3 bulloni



106	1.1 40Kw 1.4 55Kw	91>96 91>96	1.4 XSI 37Kw 1.5 40Kw	91>93 1991>
 ← Lungh. Tot. = 614 mm → Cave 21 Cave 22	RIFERIMENTI ORIGINALI		 ← Lungh. Tot. = 798 mm → Cave 22 Cave 21	
	32721K 32725J* 95666908 95666940	32730K 32735K 3273E3* 95666941		
LATO SX	PE 00103 - PE 00103/A*	A = ABS 48	A = ABS 48	PE 00104 - PE 00104/A* LATO DX



NOTE Cercio 4 bulloni - ABS 48D su richiesta

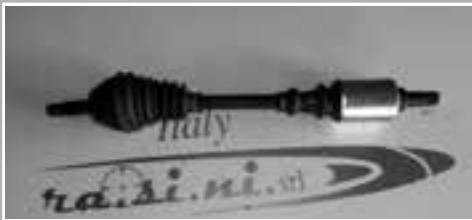

106	1.3 Rallye 72/74Kw 1.4 XSI 55/56Kw	93>96 1993>	1.6 XSI 74/76Kw	1993>
 ← Lungh. Tot. = 606 mm → Cave 21 Cave 22	RIFERIMENTI ORIGINALI		 ← Lungh. Tot. = 801 mm → Cave 22 Cave 21	
	3272G1* 3272X9*	3273N7* 32730L*		
LATO SX	PE 00105 - PE 00105/A*	Fusello L/C 58mm A = ABS 48	Fusello L/C 240mm A = ABS 48	PE 00106 - PE 00106/A* LATO DX



NOTE ABS 48D su richiesta



106	1.1 40/44Kw 1.4 55Kw	1999> 1.5 D 42/43Kw 1999>	1999>
	RIFERIMENTI ORIGINALI		
← Lungh. Tot. = 623 mm → Cave 21 Cave 22	32723Q 32722Q A = ABS 48	32737J 32737H A = ABS 48	← Lungh. Tot. = 805 mm → Cave 22 Cave 21
LATO SX PE 00188 - PE 00188/A			PE 00189 - PE 00189/A LATO DX
NOTE ABS 48D su richiesta			



106	1.6 87Kw	1999>	
	RIFERIMENTI ORIGINALI		
← Lungh. Tot. = 620 mm → Cave 21 Cave 22	32724Q 32725Q 32728Q* 32729Q* Fusello L/C 58mm A = ABS 48	32737K 32737L 32737Q* 32737R* Fusello L/C 240mm A = ABS 48	← Lungh. Tot. = 815 mm → Cave 22 Cave 21
LATO SX CI 00193 - CI 00193/A *			CI 00194 - CI 00194/A * LATO DX
NOTE ABS 48D su richiesta			



107	1.0 50Kw	2005>	
	RIFERIMENTI ORIGINALI		
← Lungh. Tot. = 648 mm → Cave 24 Cave 23	3272JY 434200H010	3273JR 434100H010	← Lungh. Tot. = 840 mm → Cave 23 Cave 24
LATO SX CI 00197			CI 00198 LATO DX
NOTE Fonico Ø 49			

107	1.4 HDI 40Kw	2005>	
	RIFERIMENTI ORIGINALI		
← Lungh. Tot. = 594 mm → Cave 24 Cave 23	3272JZ 434200H020	3273JS 434100H020	← Lungh. Tot. = 898 mm → Cave 23 Cave 24
LATO SX CI 01001			CI 01002 LATO DX
NOTE Fonico Ø 49			

1007	1.4 55Kw	2005>					
 <p>← Lungh. Tot. = 655 mm → Cave 21 Cave 22</p> <p>LATO SX PE 01148</p>	<p>RIFERIMENTI ORIGINALI</p> <table border="1"> <tr> <td>3272HP 3272HQ</td> <td>3273HF 3273HG</td> </tr> <tr> <td colspan="2">Fusello L/C 97mm</td> </tr> </table>		3272HP 3272HQ	3273HF 3273HG	Fusello L/C 97mm		 <p>← Lungh. Tot. = 858 mm → Cave 22 Cave 21</p> <p>PE 01149 LATO DX</p>
	3272HP 3272HQ	3273HF 3273HG					
Fusello L/C 97mm							
<p>NOTE</p>							

1007	1.4 16v 65Kw	2005>					
 <p>← Lungh. Tot. = 642 mm → Cave 21 Cave 22</p> <p>LATO SX CI 00187</p>	<p>RIFERIMENTI ORIGINALI</p> <table border="1"> <tr> <td>3272HR 3272RT</td> <td>3273HH 3273SG</td> </tr> <tr> <td colspan="2">Fusello L/C 58mm</td> </tr> </table>		3272HR 3272RT	3273HH 3273SG	Fusello L/C 58mm		 <p>← Lungh. Tot. = 845 mm → Cave 22 Cave 21</p> <p>CI 00188 LATO DX</p>
	3272HR 3272RT	3273HH 3273SG					
Fusello L/C 58mm							
<p>NOTE</p>							

1007	1.4 HDI 50Kw	2005>					
 <p>← Lungh. Tot. = 652 mm → Cave 21 Cave 22</p> <p>LATO SX PE 01144</p>	<p>RIFERIMENTI ORIGINALI</p> <table border="1"> <tr> <td>3272HW 3272HX</td> <td>3273HN 3273HP</td> </tr> <tr> <td>Fusello L/C 58mm</td> <td>Fusello L/C 97mm</td> </tr> </table>		3272HW 3272HX	3273HN 3273HP	Fusello L/C 58mm	Fusello L/C 97mm	 <p>← Lungh. Tot. = 855 mm → Cave 22 Cave 21</p> <p>PE 01145 LATO DX</p>
	3272HW 3272HX	3273HN 3273HP					
Fusello L/C 58mm	Fusello L/C 97mm						
<p>NOTE</p>							

1007	1.6 HDI 80Kw	2007>					
 <p>← Lungh. Tot. = 636 mm → Cave 21 Cave 24</p> <p>LATO SX PE 01146</p>	<p>RIFERIMENTI ORIGINALI</p> <table border="1"> <tr> <td>3272NR 3272NS 3272PR 3272PS</td> <td>3273NR 3273NS</td> </tr> <tr> <td colspan="2">Fusello L/C 290</td> </tr> </table>		3272NR 3272NS 3272PR 3272PS	3273NR 3273NS	Fusello L/C 290		 <p>← Lungh. Tot. = 903 mm → Cave 24 Cave 21</p> <p>PE 01147 LATO DX</p>
	3272NR 3272NS 3272PR 3272PS	3273NR 3273NS					
Fusello L/C 290							
<p>NOTE</p>							

205

1.0 33Kw
1.1 36Kw83>87 | 1.4 44Kw
83>87

83>87

← Lungh. Tot. = 710 mm →
Cave 21 Cave 22

LATO SX

PE 00107

RIFERIMENTI ORIGINALI

327492
327493← Lungh. Tot. = 710 mm →
Cave 22 Cave 21

PE 00107

LATO DX

NOTE

205

1.0 37Kw
1.1 40Kw1987> |
1987>← Lungh. Tot. = 574 mm →
Cave 21 Cave 22

LATO SX

PE 00108

RIFERIMENTI ORIGINALI

327215
327216
327219327384
327385
327388← Lungh. Tot. = 833 mm →
Cave 22 Cave 21

PE 00109

LATO DX

NOTE

205

1.3 Rallye 74/76Kw
1.4 55/56Kw1987> |
1987>← Lungh. Tot. = 575 mm →
Cave 21 Cave 22

LATO SX

PE 00110

RIFERIMENTI ORIGINALI

3272R3
96021730

96021731

← Lungh. Tot. = 835 mm →
Cave 22 Cave 21

PE 00111

LATO DX

NOTE Campana L/R Ø 86

205

1.6 65/69Kw
1.7 D 44Kw1984> | 1.8 Turbo D 57/66Kw
1.9 D 47/48Kw1990> |
1983>← Lungh. Tot. = 570 mm →
Cave 21 Cave 24

LATO SX

PE 00112

RIFERIMENTI ORIGINALI

327220
3272K2327389
3273R6
95591074← Lungh. Tot. = 840 mm →
Cave 24 Cave 21

PE 00113

LATO DX

NOTE

205	1.9 GTI-CTI	1986>		
<p>Lungh. Tot. = 567 mm Cave 25 Cave 24</p> <p>LATO SX PE 00114</p>	RIFERIMENTI ORIGINALI		<p>Lungh. Tot. = 567 mm Cave 24 Cave 25</p> <p>PE 00115 LATO DX</p>	
	327201 3272A1	327371 3273J9		
NOTE ABS 48D-90D su richiesta				

206	1.1 44Kw 1.4 55Kw	1998> 1998>		
<p>Lungh. Tot. = 615 mm Cave 21 Cave 22</p> <p>LATO SX PE 00180 - PE 00180/A</p>	RIFERIMENTI ORIGINALI		<p>Lungh. Tot. = 890 mm Cave 22 Cave 21</p> <p>PE 00181 - PE 00181/A* LATO DX</p>	
	32723L* 32724C* 32726E	32733M* 32733X 9630767280*		A = ABS 48
NOTE ABS 48D su richiesta				

206	1.4 HDI 50Kw 1.6 65Kw	2001> 98>00		
<p>Lungh. Tot. = 608 mm Cave 21 Cave 22</p> <p>LATO SX PE 00190 - PE 00190/A*</p>	RIFERIMENTI ORIGINALI		<p>Lungh. Tot. = 890 mm Cave 22 Cave 21</p> <p>PE 00181 - PE 00181/A* LATO DX</p>	
	32733X* 32728E 9630767880 3272XJ	32733M* 32733X 9639767280		Fusello L/C 58mm
NOTE ABS 48D su richiesta				

206	1.9 D 51Kw	1998>		
<p>Lungh. Tot. = 606 mm Cave 21 Cave 24</p> <p>LATO SX PE 00182 - PE 00182/A</p>	RIFERIMENTI ORIGINALI		<p>Lungh. Tot. = 905 mm Cave 24 Cave 21</p> <p>PE 00183 - PE 00183/A LATO DX</p>	
	3272Y0 3272Y1 3273AQ*	32730M 32730N* 32730P		A = ABS 48
NOTE ABS 48D su richiesta				

206

1.6 16v 80Kw

2000>



← Lungh. Tot. = 600 mm →
Cave 25 Cave 22

LATO SX **PE 01101 - PE 01101/A**

RIFERIMENTI ORIGINALI

3272AA
3272AC
3273AE*
3273AF*

Fusello L/C 58mm
A = ABS 48

3273AL*
3273AN*
32734Y
32734Z

A = ABS 48



← Lungh. Tot. = 880 mm →
Cave 22 Cave 25

PE 01102 - PE 01102/A LATO DX**NOTE** ABS 48D su richiesta

206

2.0 16v 66Kw
2.0 HDI 99Kw1999>
99>00

Fino al telaio n. 08792



← Lungh. Tot. = 592 mm →
Cave 25 Cave 24

LATO SX **PE 00184 - PE 00184/A***

RIFERIMENTI ORIGINALI

3272Y0
3272Z0*

Fusello L/C 62mm
A = ABS 48 Ø 99

32720Z*
32730Y
32730Z

A = ABS 48 Ø 99



← Lungh. Tot. = 890 mm →
Cave 24 Cave 25

PE 00185 - PE 00185/A LATO DX**NOTE** ABS 48D su richiesta

206

2.0 HDI 66Kw

1999>

Dal telaio n. 08793



← Lungh. Tot. = 600 mm →
Cave 25 Cave 24

LATO SX **PE 00192 - PE 00192/A**

RIFERIMENTI ORIGINALI

3272FA
3272ZO
3272EZ
3272Y9

A = ABS 48 Ø 99

32720Z*
32730Y
32730Z

A = ABS 48 Ø 99



← Lungh. Tot. = 890 mm →
Cave 24 Cave 25

PE 00185 - PE 00185/A LATO DX**NOTE** ABS 48D su richiesta

207

1.4 53/54Kw
1.4 16v 65Kw2006>
2006>

← Lungh. Tot. = 655 mm →
Cave 21 Cave 22

LATO SX **PE 01103**

RIFERIMENTI ORIGINALI

3272KX
3272KW

Fusello L/C 58mm



3273KJ
3273KK

Fusello L/C 97mm





← Lungh. Tot. = 852 mm →
Cave 22 Cave 21



PE 01104 LATO DX**NOTE** Fonico Ø 48,4

207	1.4 16V 70Kw 1.4 HDI 50Kw	2007> 2006>	1.6 16V VTI 88Kw	2007>
	RIFERIMENTI ORIGINALI			
← Lungh. Tot. = 640 mm → Cave 25 Cave 22	3272LA 3272LC	3273KP 3273KQ	← Lungh. Tot. = 852 mm → Cave 22 Cave 25	
LATO SX	PE 01115	Fusello L/C 58mm Fusello L/C 97mm	PE 01116	LATO DX



NOTE Fonico Ø 59

207	1.6 HDI 66/68/80/82Kw 1.6 16v Turbo 110/115Kw	2006> 2006>		
	RIFERIMENTI ORIGINALI			
← Lungh. Tot. = 635 mm → Cave 25 Cave 24	3272LG 3272LH	3273KR 3273KS	← Lungh. Tot. = 860 mm → Cave 24 Cave 25	
LATO SX	PE 01126	Fusello L/C 62mm Fusello L/C 290mm	PE 01127	LATO DX

NOTE ABS 48

207	1.6 16v Turbo 110Kw	2006>		
	RIFERIMENTI ORIGINALI			
← Lungh. Tot. = 640 mm → Cave 25 Cave 24	3272P2 3272QA	3272QK	← Lungh. Tot. = 860 mm → Cave 24 Cave 25	
LATO SX	PE 01022	Fusello L/C 62mm	PE 01023	LATO DX

NOTE Fonico Ø 57,5

208	1.0 50Kw 1.2 60Kw	2012> 2012>	1.4 HDI 50Kw 1.6 88Kw	2012> 2012>
	RIFERIMENTI ORIGINALI			
← Lungh. Tot. = 650 mm → Cave 21 Cave 22	10275125A 9803959580	10275124A 9801611280	← Lungh. Tot. = 865 mm → Cave 22 Cave 21	
LATO SX	PE 01150	Fusello L/C 58mm Fusello L/C 97mm	PE 01151	LATO DX

NOTE Fonico Ø 49

2008

1.6 88Kw
1.6 HDI 85Kw2014>
2014← Lungh. Tot. = 625 mm →
Cave 25 Cave 24

LATO SX

CI 01003

RIFERIMENTI ORIGINALI

L/C 62

L/365

← Lungh. Tot. = 945 mm →
Cave 24 Cave 25

CI 01004

LATO DX

NOTE

306

1.1 44Kw
1.4 55Kw1993>
1993>← Lungh. Tot. = 611 mm →
Cave 21 Cave 22

LATO SX

PE 00116 - /A - /B

RIFERIMENTI ORIGINALI

327275
3272H83272G1
3273Q2
3273Z4A = ABS 48
B = ABS 29A = ABS 48
B = ABS 29← Lungh. Tot. = 880 mm →
Cave 22 Cave 21

PE 00117 - /A - /B

LATO DX

NOTE ABS 29D-48D su richiesta

306

1.6 65Kw

93>00

← Lungh. Tot. = 600 mm →
Cave 25 Cave 22

LATO SX

PE 00118 - /A - /B

RIFERIMENTI ORIGINALI

3272H7

3273G3
3273Q1Fusello L/C 58mm
A = ABS 48
B = ABS 29A = ABS 48
B = ABS 29← Lungh. Tot. = 880 mm →
Cave 22 Cave 25

PE 00119 - /A - /B

LATO DX

NOTE ABS 29D-48D su richiesta

306

1.9 D 51Kw
1.8 74Kw93>01 | 1.9 D 47/50/55Kw
93>01 | 2.0 89Kw93>01 |
94>01← Lungh. Tot. = 610 mm →
Cave 25 Cave 24

LATO SX

PE 00120 - /A - /B



RIFERIMENTI ORIGINALI



32720C
327212
327210
327211
3272C73272L4
327379
327381
3273G8
3273K9A = ABS 29
B = ABS 48A = ABS 29
B = ABS 48← Lungh. Tot. = 885 mm →
Cave 24 Cave 25



PE 00121 - /A - /B



LATO DX

NOTE

306	1.9 SRDT 66Kw 2.0 HDI 66Kw	1993> 2.0 S 16 110/112Kw 1993>	
	RIFERIMENTI ORIGINALI		
← Lungh. Tot. = 600 mm → Cave 25 Cave 24	32720G 3272E1 3272F6 3272F8 Fusello L/C 62mm A = ABS 29	3272L2 3272L3 32731H 3273K6 3273L1 A = ABS 29	← Lungh. Tot. = 886 mm → Cave 24 Cave 25
LATO SX PE 00124 - PE 00124/A			PE 00125 - PE 00125/A LATO DX
NOTE ABS 29D			

307	1.4 55Kw 1.4 16v 65Kw	2000> 1.6 80Kw 2003>	2000>
	RIFERIMENTI ORIGINALI		
← Lungh. Tot. = 627 mm → Cave 25 Cave 22	3272X 9636786780 32725X Fusello L/C 58mm	3273AJ 3273AH 9636786880	← Lungh. Tot. = 915 mm → Cave 22 Cave 25
LATO SX PE 00196			PE 00197 LATO DX
NOTE Fonico Ø 57,5			

307	1.4 HDI 50Kw 1.6 16v 80Kw	2001> 1.6 HDI 2000> 2.0 HDI 79/100Kw	
	RIFERIMENTI ORIGINALI		
← Lungh. Tot. = 628 mm → Cave 25 Cave 24	32721X 32722X Fusello L/C 62mm	3273LP 9637117880	← Lungh. Tot. = 925 mm → Cave 24 Cave 25
LATO SX PE 00193			PE 00198 LATO DX
NOTE Fonico Ø 58,5			

307	2.0 HDI 100Kw	2003>	
	RIFERIMENTI ORIGINALI		
← Lungh. Tot. = 670 mm → Cave 25 Cave 37	3272FT 3272FV Fusello L/C 62mm	9645219180 3273CZ 3273CY	← Lungh. Tot. = 932 mm → Cave 37 Cave 25
LATO SX PE 01140			PE 01141 LATO DX
NOTE			

307

2.0 HDI 79/100Kw
1.6 HDI 80Kw2000>
2004>← Lungh. Tot. = 635 mm →
Cave 25 Cave 24

LATO SX

PE 00186

RIFERIMENTI ORIGINALI

32728W
32729W
32721X
32722X9637117880
3272AC
3273AE

Fusello L/C 69mm

← Lungh. Tot. = 925 mm →
Cave 24 Cave 25

PE 00198

LATO DX

NOTE Fonico Ø 58,5

308

1.4 16v 70Kw
1.6 16v 88/103/115Kw2007>
2007>

1.6 HDI 66/80Kw

2007>

← Lungh. Tot. = 645 mm →
Cave 25 Cave 24

LATO SX

PE 01022

RIFERIMENTI ORIGINALI

3272LH
3272TZ
3272LG
3272 QA
3272PZ
96607828803273VN
3273VP
3272QK
9660782780← Lungh. Tot. = 950 mm →
Cave 24 Cave 25

PE 01023

LATO DX

NOTE

308

2.0 HDI 82/100/103/110/120Kw
2007>← Lungh. Tot. = 665 mm →
Cave 25 Cave 37

LATO SX

PE 01024

RIFERIMENTI ORIGINALI

3272QH
3272QJ3273QS
3273QT

Fusello L/C 365mm

← Lungh. Tot. = 955 mm →
Cave 37 Cave 25

PE 01025

LATO DX

NOTE

309

1.1
1.3 47/48Kw85>89
85>89← Lungh. Tot. = 570 mm →
Cave 21 Cave 24

LATO SX

PE 00126



RIFERIMENTI ORIGINALI

327348
327349
327221327351
327390
327352← Lungh. Tot. = 845 mm →
Cave 24 Cave 21



PE 00127

LATO DX



NOTE ABS 54D su richiesta

<p>309</p> <p>1.1 40/44Kw 1.4 49Kw</p> <p>89>93 90>93</p>	<p>RIFERIMENTI ORIGINALI</p>		 <p>Lungh. Tot. = 850 mm Cave 22 Cave 25</p> <p>PE 00131 LATO DX</p>
	 <p>Lungh. Tot. = 588 mm Cave 25 Cave 22</p> <p>LATO SX PE 00130</p>	<p>327227 327228</p>	



NOTE

<p>309</p> <p>1.6 65/69Kw 1.8 Diesel - TD 57/66Kw</p> <p>1989> 1986></p>	<p>RIFERIMENTI ORIGINALI</p>		 <p>Lungh. Tot. = 845 mm Cave 24 Cave 25</p> <p>PE 00133 LATO DX</p>
	 <p>Lungh. Tot. = 577 mm Cave 25 Cave 24</p> <p>LATO SX PE 00132</p>	<p>327391 327327 327357 3273H9</p>	

NOTE

<p>309</p> <p>1.1 l 1.1</p> <p>89>93 89>93</p>	<p>RIFERIMENTI ORIGINALI</p>		 <p>Lungh. Tot. = 845 mm Cave 22 Cave 21</p> <p>PE 00129 LATO DX</p>
	 <p>Lungh. Tot. = 586 mm Cave 21 Cave 22</p> <p>LATO SX PE 00128</p>	<p>327244 327245</p>	

NOTE

<p>3008</p> <p>1.6 HDI 82Kw 2.0 HDI 110/120Kw</p> <p>06/09> 06/09></p>	<p>RIFERIMENTI ORIGINALI</p>		 <p>Lungh. Tot. = 955 mm Cave 37 Cave 25</p> <p>PE 01025 LATO DX</p>
	 <p>Lungh. Tot. = 665 mm Cave 25 Cave 37</p> <p>LATO SX PE 01024</p>		

NOTE Fonico Ø 57,5

3008

1.6 HDI 80Kw

2009>



← Lungh. Tot. = 625 mm →
Cave 25 Cave 24

LATO SX

CI 01003

RIFERIMENTI ORIGINALI

3272PZ
3272QA3273QK
3273QL

Fusello L/C 62mm

Fusello L/C 365mm



← Lungh. Tot. = 945 mm →
Cave 24 Cave 25

CI 01004

LATO DX

NOTE Fonico Ø 59,5

405

1.6 53/69Kw
1.8 D1987> | 1.9 D 50/51Kw
1987>

1987>



← Lungh. Tot. = 608 mm →
Cave 25 Cave 24

LATO SX

PE 00136 - /A - /B

RIFERIMENTI ORIGINALI

327210
327211
327212327379
327381
3273L4A = ABS 29
B = ABS 90A = ABS 29
B = ABS 90

← Lungh. Tot. = 880 mm →
Cave 24 Cave 25

PE 00137 - /A - /B

LATO DX

NOTE ABS 29D-90D su richiesta

405

1.4 47/55Kw

1987>



← Lungh. Tot. = 610 mm →
Cave 25 Cave 22

LATO SX

PE 00134

RIFERIMENTI ORIGINALI

327277
327374
327375327305
327306

← Lungh. Tot. = 880 mm →
Cave 22 Cave 25

PE 00135

LATO DX

NOTE

405

1.8 Turbo D 66Kw
1.9 77/88/108Kw87>92 | 1.9 TD 53/68Kw
87>92

87>92



← Lungh. Tot. = 608 mm →
Cave 25 Cave 24

LATO SX

PE 00138 - /A - /B

RIFERIMENTI ORIGINALI



327209
3272H3327378
3273P7A = ABS 29
B = ABS 90A = ABS 29
B = ABS 90

← Lungh. Tot. = 877 mm →
Cave 24 Cave 25



PE 00139 - /A - /B

LATO DX



NOTE ABS 29D-90D su richiesta

<p>405</p> <p>1.8 I 74Kw 1.9 ETD 50/66Kw</p>  <p>← Lungh. Tot. = 600 mm → Cave 25 Cave 24</p> <p>LATO SX</p>	<p>1992> 2.0 GRI-SRI-MI16-SRI 4X4 1992> 89/110/112Kw</p> <p>1992> </p>		<p>RIFERIMENTI ORIGINALI</p> <table border="1"> <tr> <td>32720G 32720F 3272E1 327261</td> <td>3273K6 32731H 3273C5 32731J</td> </tr> <tr> <td>Fusello L/C 62mm A = ABS 29 B = ABS 90</td> <td>A = ABS 29 B = ABS 90</td> </tr> </table>	32720G 32720F 3272E1 327261	3273K6 32731H 3273C5 32731J	Fusello L/C 62mm A = ABS 29 B = ABS 90	A = ABS 29 B = ABS 90	<p></p> <p>← Lungh. Tot. = 886 mm → Cave 24 Cave 25</p> <p>LATO DX</p>
	32720G 32720F 3272E1 327261	3273K6 32731H 3273C5 32731J						
Fusello L/C 62mm A = ABS 29 B = ABS 90	A = ABS 29 B = ABS 90							
<p>PE 00140 - /A - /B</p>		<p>PE 00141 - /A - /B</p>						



NOTE ABS 29D-90D su richiesta

<p>406</p> <p>1.6 SL 65Kw 1.8 SL-ST 16V 66/81Kw</p>  <p>← Lungh. Tot. = 627 mm → Cave 25 Cave 24</p> <p>LATO SX</p>	<p>95>04 1.9 D 55Kw 95>04 1.9 TD 55/66/68Kw</p> <p>96>04 96>04 </p>		<p>RIFERIMENTI ORIGINALI</p> <table border="1"> <tr> <td>3272S2 3272S5</td> <td>3273Y7 3273Y9</td> </tr> <tr> <td>A = ABS 29 Ø 99 B = ABS 48 Ø 99</td> <td>A = ABS 29 Ø 99 B = ABS 48 Ø 99</td> </tr> </table>	3272S2 3272S5	3273Y7 3273Y9	A = ABS 29 Ø 99 B = ABS 48 Ø 99	A = ABS 29 Ø 99 B = ABS 48 Ø 99	<p></p> <p>← Lungh. Tot. = 908 mm → Cave 24 Cave 25</p> <p>LATO DX</p>
	3272S2 3272S5	3273Y7 3273Y9						
A = ABS 29 Ø 99 B = ABS 48 Ø 99	A = ABS 29 Ø 99 B = ABS 48 Ø 99							
<p>PE 00142 - /A - /B</p>		<p>PE 00143 - /A - /B</p>						

NOTE ABS 29D-48D

<p>406</p> <p>1.9 TD 2.0</p>  <p>← Lungh. Tot. = 619 mm → Cave 25 Cave 24</p> <p>LATO SX</p>	<p>95>04 2.0 16v 95>04 2.0 HDI</p>		<p>RIFERIMENTI ORIGINALI</p> <table border="1"> <tr> <td>32721P° 32722P° 3272S3* 3272S6*</td> <td>32725P° 32726P° 3273Y7* 3272y9*</td> </tr> <tr> <td>Fusello L/C 62mm A = ABS 29 Ø 99 B = ABS 48 Ø 99</td> <td>A = ABS 29 Ø 99 B = ABS 48 Ø 99</td> </tr> </table>	32721P° 32722P° 3272S3* 3272S6*	32725P° 32726P° 3273Y7* 3272y9*	Fusello L/C 62mm A = ABS 29 Ø 99 B = ABS 48 Ø 99	A = ABS 29 Ø 99 B = ABS 48 Ø 99	<p>95>04 2.0 Turbo 95>04 </p> <p>95>04 </p> <p></p> <p>← Lungh. Tot. = 908 mm → Cave 24 Cave 25</p> <p>LATO DX</p>
	32721P° 32722P° 3272S3* 3272S6*	32725P° 32726P° 3273Y7* 3272y9*						
Fusello L/C 62mm A = ABS 29 Ø 99 B = ABS 48 Ø 99	A = ABS 29 Ø 99 B = ABS 48 Ø 99							
<p>PE 00144 - /A* - /B°</p>		<p>PE 00145 - /A* - /B°</p>						

NOTE ABS 29D-48D su richiesta

<p>406</p> <p>2.0 Turbo SV 108Kw 2.1 TD 12v 90Kw</p>  <p>← Lungh. Tot. = 621 mm → Cave 25 Cave 37</p> <p>LATO SX</p>	<p>96>99 3.0 V6 24S 140/152Kw 96>99 2.0 HDI 66/80Kw</p> <p>96>99 96>99 </p>		<p>RIFERIMENTI ORIGINALI</p> <table border="1"> <tr> <td>32726P 32725P</td> <td>3273Z0 3273Z1</td> </tr> <tr> <td>Fusello L/C 362mm</td> <td></td> </tr> </table>	32726P 32725P	3273Z0 3273Z1	Fusello L/C 362mm		<p></p> <p>← Lungh. Tot. = 925 mm → Cave 37 Cave 25</p> <p>LATO DX</p>
	32726P 32725P	3273Z0 3273Z1						
Fusello L/C 362mm								
<p>PE 00146</p>		<p>PE 00147</p>						

NOTE ABS 29D

406

2.0 HDI 79Kw
2.1 TD 80Kw\99>0401>04 | 2.2 116Kw
2.2 HDI 98Kw

3.0 140/152Kw



← Lungh. Tot. = 621 mm →

LATO SX

PE 01113

RIFERIMENTI ORIGINALI

32725P
32726P32736Y
32736Y

ABS 48 Ø 99

ABS 48 Ø 99



← Lungh. Tot. = 925 mm →

PE 01114

LATO DX

NOTE ABS 48D

407

1.6 HDI 80Kw
1.8 85Kw2004> | 1.8 16v 92Kw
2004>

2004>

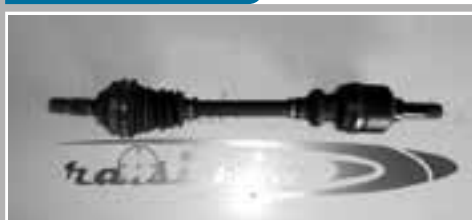
← Lungh. Tot. = 670 mm →
Cave 28 Cave 24

LATO SX

PE 01124

RIFERIMENTI ORIGINALI

3272GH
3272GG3273EG
3273FA← Lungh. Tot. = 958 mm →
Cave 24 Cave 28

PE 01125

LATO DX

NOTE

407

2.0 HDI 100/103Kw

2008>

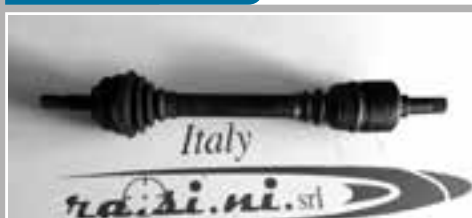
← Lungh. Tot. = 655 mm →
Cave 28 Cave 37

LATO SX

PE 01120

RIFERIMENTI ORIGINALI

3272GN

3273GC
3273GE← Lungh. Tot. = 970 mm →
Cave 37 Cave 28

PE 01121

LATO DX

NOTE Fonico Ø 59

508

1.6 HDI 82/85Kw
2.0 HDI 103/120Kw2010> |
2010>

← →

LATO SX

FI 01020

RIFERIMENTI ORIGINALI



3272YR
3272YS3273NP
3273NQ



← →



FI 01021



LATO DX

NOTE

5008	1.6 16v 115Kw 1.6 HDI 82Kw	09/09> 09/09>	RIFERIMENTI ORIGINALI		
			3272QA 3272PZ 9684135380	3272QK	
← Lungh. Tot. = 625 mm → Cave 25 Cave 24			Fusello L/C 62mm	Fusello L/C 365mm	← Lungh. Tot. = 945 mm → Cave 24 Cave 25
LATO SX	CI 01003				CI 01004 LATO DX
NOTE Ø 59					

605	2.0 Turbo 108Kw 2.1 TD 80Kw	89>94 89>94	3.0 SV- SV 24v 123/147Kw	89>94	
					
← Lungh. Tot. = 646 mm → Cave 28 Cave 37			A = ABS 29 B = ABS 48	A = ABS 29 B = ABS 48	← Lungh. Tot. = 936 mm → Cave 37 Cave 28
LATO SX	PE 00150 - /A - /B				PE 00151 - /A - /B LATO DX
NOTE ABS 29D-48D su richiesta					

605	2.0 97/99Kw 2.0 Turbo 108Kw	1994> 1994>	2.1 TD 80Kw 3.0 123/147Kw	1994> 1994>	
					
← Lungh. Tot. = 650 mm → Cave 28 Cave 37			A = ABS 29	A = ABS 29	← Lungh. Tot. = 953 mm → Cave 37 Cave 28
LATO SX	PE 00152 - PE 00152/A				PE 00153 - PE 00153/A LATO DX
NOTE ABS 29D su richiesta					

605	2.0 80/84Kw 2.1	1989> 1989>	RIFERIMENTI ORIGINALI		
			327290 3272J9 9614188080	3273C1 3273C6 95643952	
← Lungh. Tot. = 654 mm → Cave 28 Cave 24			Fusello L/C 62mm A = ABS 29 B = ABS 48	A = ABS 29 B = ABS 48	← Lungh. Tot. = 940 mm → Cave 24 Cave 28
LATO SX	PE 00148 - /A - /B				PE 00149 - /A - /B LATO DX
NOTE ABS 29D-48D su richiesta					

605

2.5 TD 95Kw
3.0 123/147Kw1994>
1994>

← Lungh. Tot. = 641 mm →
Cave 28 Cave 41

LATO SX **PE 00154 - PE 00154/A***

RIFERIMENTI ORIGINALI

3272N5*
3272N7*3273V1
3273V3

Fusello L/C 380mm



← Lungh. Tot. = 956 mm →
Cave 41 Cave 28

PE 00155 - PE 00155/A* LATO DX**NOTE** ABS 48D

607

2.0 16v 100Kw

06>11

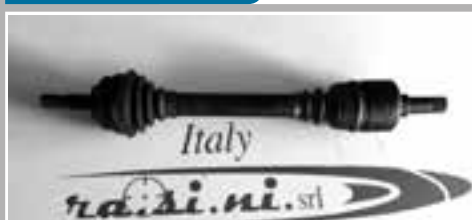

← Lungh. Tot. = 665 mm →
Cave 28 Cave 37

LATO SX **PE 01109**

RIFERIMENTI ORIGINALI

3272NH
3272NJ3273NH
3273NJ

Fusello L/C 365mm



← Lungh. Tot. = 970 mm →
Cave 37 Cave 28

PE 01110 LATO DX**NOTE** Fonico Ø 59 - * Ø 29

607

2.0 HDI 100Kw
2.2 HDI 98/116/120Kw1999>
1999>

← Lungh. Tot. = 655 mm →
Cave 28 Cave 37

LATO SX **PE 00194**

RIFERIMENTI ORIGINALI

32725S

32737Y
9806134180
9806134380

Fusello L/C 398mm



← Lungh. Tot. = 970 mm →
Cave 37 Cave 28

PE 00195 LATO DX**NOTE** ABS 48D

806

1.8 75Kw
2.0 89/90Kw1996>
1994>

← Lungh. Tot. = 648 mm →
Cave 27 Cave 24

LATO SX **FI 00120 - FI 00120/A**

RIFERIMENTI ORIGINALI



32721L*
3272M0*
3272P5*
96199475883273TG*
3273V*
3273W0*
9619947688Fusello L/C 62mm
A = ABS 48



A = ABS 48





← Lungh. Tot. = 935 mm →
Cave 24 Cave 27

FI 00121 - FI 00121/A LATO DX**NOTE** ABS 48D su richiesta

806	1.9 TD 66Kw 2.0 Turbo 108Kw	1994> 2.0 HDI 1994> 2.1 TD 80Kw	1999> 1996>
	RIFERIMENTI ORIGINALI		
← Lungh. Tot. = 640 mm → Cave 27 Cave 37	96174048188	9617408288	← Lungh. Tot. = 940 mm → Cave 37 Cave 27
LATO SX FI 00122 - FI 00122/A	A = ABS 48		FI 00123 - FI 00123/A LATO DX
NOTE ABS 48D su richiesta			

Bipper	1.3 HDI 55Kw	2008>	
	RIFERIMENTI ORIGINALI		
← Lungh. Tot. = 610 mm → Cave 25 Cave 24	21023916 1607440280	1607440180	← Lungh. Tot. = 920 mm → Cave 24 Cave 25
LATO SX PE 01054	Fusello L/C 390mm		PE 01055 LATO DX
NOTE Fonico Ø 51			

Bipper	1.3 HDI 55Kw	2008>	
	RIFERIMENTI ORIGINALI		
← Lungh. Tot. = 610 mm → Cave 25 Cave 24	1607440280	1607440180	← Cave 24 Cave 25 →
LATO SX FI 01037	Fusello L/C 390mm		FI 01038 LATO DX
NOTE			

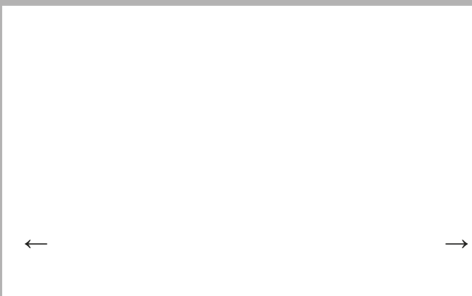
Bipper	1.4 Bi Poller		
	RIFERIMENTI ORIGINALI		
← →			← →
LATO SX AR 00158			AR 00159 LATO DX
NOTE			

Bipper	1.4 HDI 50Kw	2008>		
	RIFERIMENTI ORIGINALI			
← Lungh. Tot. = 660 mm → Cave 25 Cave 22	51783854 3272SL 3272SN	3273TE	← Lungh. Tot. = 885 mm → Cave 22 Cave 25	
LATO SX	Fusello L/C 58mm	Fusello L/C 97mm	LATO DX	
PE 01052			PE 01053	

NOTE Fonico Ø 51

Bipper	1.4 54Kw	02/2008>		
	RIFERIMENTI ORIGINALI			
← Lungh. Tot. = 650 mm → Cave 22 Cave 22	3272SJ 3272SZ 51783853 3272SK	51783825	← Lungh. Tot. = 882 mm → Cave 22 Cave 22	
LATO SX	Fusello L/C 58mm	Fusello L/C 97mm	LATO DX	
PE 01150			PE 01151	



NOTE Fonico Ø 51

Boxer	1.9 D, D 4x4 51Kw 1.9 TD	1994> 2.0 1994> 2.5 D 63Kw	1994> 1994>	
	RIFERIMENTI ORIGINALI			
← Lungh. Tot. = 765 mm → Cave 28 Cave 37	32726K* 3272CH* 3272J0* 3272J3*	32735S 3273CK 3273Q5 3273Q8	← Lungh. Tot. = 1065 mm → Cave 37 Cave 28	
LATO SX	10-14 q.li	A = ABS 54 10-14 q.li	LATO DX	
FI 00127 - FI 00127/A			FI 00128 - FI 00128/A	

NOTE 10-14 q.li - ABS 54D su richiesta

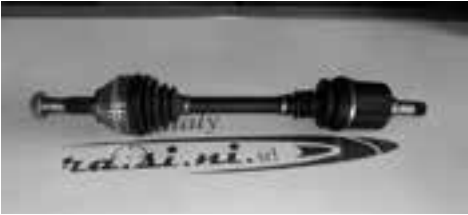

Boxer	2.5 TD 76Kw 2.0	1994> 2.5 D 63Kw 1994> 2.8 HDI 94Kw	1994> 1994>	
	RIFERIMENTI ORIGINALI			
← Lungh. Tot. = 770 mm → Cave 28 Cave 41	32727K* 3273CK* 3272CL* 3272J1* 3272J5*	3273CK* 3273Q6* 3273R0* 3273ST*	← Lungh. Tot. = 1070 mm → Cave 41 Cave 28	
LATO SX	10-14 q.li	A = ABS 54 10-14 q.li	LATO DX	
FI 00129 - FI 00129/A			FI 00130 - FI 00130/A	



NOTE 10-14 q.li - ABS 54D su richiesta



Boxer	2.0 2.5 D 63Kw	1994> 2.5 TD 76Kw 1994> 2.5 TDI 79Kw	1994> 2.8 HDI 94Kw 1994>	1994>
	RIFERIMENTI ORIGINALI			
← Lungh. Tot. = 765 mm → Cave 35 Cave 41	3272J2 1478551080 3272CN 3272J1* 1463107080* 3272CK*	3273Q7 1478552080* 32735V*	← Lungh. Tot. = 1065 mm → Cave 41 Cave 35	
LATO SX FI 00131 - FI 00131/A	A = ABS 54 18 q.li	A = ABS 54 18 q.li	FI 00132 - FI 00132/A LATO DX	
NOTE 18 q.li - ABS 54D su richiesta				



Boxer	2.2 HDI 74/81/88Kw		
	RIFERIMENTI ORIGINALI		
← Lungh. Tot. = →			← Lungh. Tot. = →
LATO SX PE 01030			PE 01031 LATO DX
NOTE			

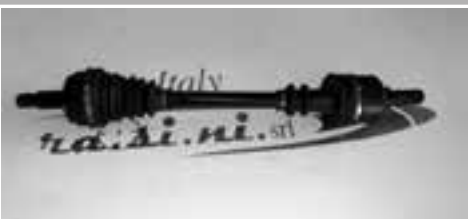

Boxer	3.0 HDI 115/130Kw		
	RIFERIMENTI ORIGINALI		
← Lungh. Tot. = →			← Lungh. Tot. = →
LATO SX PE 01032			PE 01033 LATO DX
NOTE			

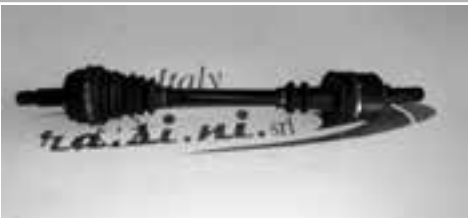

Expert	1.6 58Kw 1.8 26Kw	1995> 1.9 D 50/51Kw 1995>	1995>
	RIFERIMENTI ORIGINALI		
← Lungh. Tot. = 648 mm → Cave 27 Cave 24	32721L* 3272M0* 3272P5* 9619947588	3273TG* 3273V* 3273W0* 9619947688	← Lungh. Tot. = 935 mm → Cave 24 Cave 27
LATO SX FI 00120 - FI 00120/A	Fusello L/C 62 A = ABS 48	A = ABS 48	FI 00121 - FI 00121/A LATO DX
NOTE ABS 48D su richiesta			



Expert	1.9 TD 66Kw 2.0 HDI 80Kw	1995> 1999>		
	RIFERIMENTI ORIGINALI			
← Lungh. Tot. = 640 mm → Cave 27 Cave 37	96174048188 A = ABS 48	9617408288 A = ABS 48	← Lungh. Tot. = 940 mm → Cave 37 Cave 27	
LATO SX FI 00122 - FI 00122/A			FI 00123 - FI 00123/A LATO DX	
NOTE ABS 48D su richiesta				



Expert	1.6 HDI 66Kw	01/07>		
	RIFERIMENTI ORIGINALI			
← Lungh. Tot. = 668 mm → Cave 28 Cave 24			← Lungh. Tot. = 955 mm → Cave 24 Cave 28	
LATO SX FI 01026			FI 01027 LATO DX	
NOTE				



Expert	2.0 HDI 94-100-124Kw	01/07>		
	RIFERIMENTI ORIGINALI			
← Lungh. Tot. = 652 mm → Cave 28 Cave 37	3272CX		← Lungh. Tot. = 965 mm → Cave 37 Cave 28	
LATO SX FI 01020			FI 01021 LATO DX	
NOTE				



J5	1.8 49/51Kw 2.0 55/58Kw	>1987 >1987	2.5 D-TD 54/70Kw	>1987
	RIFERIMENTI ORIGINALI			
← Lungh. Tot. = 693 mm → Cave 28 Cave 25	9607411480 9559529280 9617303280	9559529480 9555511780 95555117 9607411180	← Lungh. Tot. = 1063 mm → Cave 25 Cave 28	
LATO SX CI 00119			CI 00120 LATO DX	
NOTE Fusello L/R 104mm				

J5	1.9 50/51Kw	>1987	
	RIFERIMENTI ORIGINALI		
← Lungh. Tot. = 693 mm → Cave 28 Cave 25	9607411480 9559529280 9617303280	3273C7 3273N4 327478	← Lungh. Tot. = 1064 mm → Cave 25 Cave 28
LATO SX	CI 00119		CI 00122 LATO DX
NOTE Fusello L/R 104mm			



J5	1.8 49/51Kw 2.0 55/58Kw	87>94 87>94	2.5 D-TD 54/70Kw	87>94
	RIFERIMENTI ORIGINALI			
← Lungh. Tot. = 702 mm → Cave 28 Cave 25	327248 9607411180	3722H2	← Lungh. Tot. = 1070 mm → Cave 25 Cave 28	
LATO SX	FI 00125	Fusello 112	CI 00124 LATO DX	
NOTE Fusello L/R 112mm				

J5	1.9 D 50/51Kw	87>94	
	RIFERIMENTI ORIGINALI		
← Lungh. Tot. = 702 mm → Cave 28 Cave 25	32727N	327362 32736R 3273C7 327478 96184033	← Lungh. Tot. = 1068 mm → Cave 25 Cave 28
LATO SX	FI 00125	Fusello 112	FI 00126 LATO DX
NOTE Fusello L/R 112mm			



Partner Ranch	1.1 40/44Kw 1.4 55Kw	1996> 1996>	
	RIFERIMENTI ORIGINALI		
← Lungh. Tot. = 594 mm → Cave 25 Cave 22	3272Y6 3272Y7	32730W 32730X	← Lungh. Tot. = 860 mm → Cave 22 Cave 25
LATO SX	CI 00105		CI 00106 LATO DX
NOTE			

Partner Ranch	1.8 D 44Kw 1.8 I 66Kw	1996> 1996>	1.9 D 50/51Kw	1996>
	RIFERIMENTI ORIGINALI			
← Lungh. Tot. = 592 mm → Cave 25 Cave 24	3272A9 3272Y4* 96171856 96171874*	A = ABS 29	32730S* 96167304 96171875*	← Lungh. Tot. = 870 mm → Cave 24 Cave 25
LATO SX CI 00163 - CI 00163/A*				CI 00164 - CI 00164/A LATO DX



NOTE ABS 29D su richiesta

Partner Ranch	2.0 HDI 66Kw	2000>		
	RIFERIMENTI ORIGINALI			
← Lungh. Tot. = 590 mm → Cave 25 Cave 24	32721S 32722S 3272FQ	A = ABS 29	32737W 32730S 32730T	← Lungh. Tot. = 872 mm → Cave 24 Cave 25
LATO SX PE 01040 - PE 01040/A				PE 01041 - PE 01041/A LATO DX



NOTE ABS 29D su richiesta

Partner Ranch	1.6 16v 80Kw 1.6 HDI 55/66Kw	2000> 2005>	2.0 HDI 66Kw	1999>
	RIFERIMENTI ORIGINALI			
← Lungh. Tot. = 583 mm → Cave 25 Cave 24	3272KL	ABS 48	3273JY	← Lungh. Tot. = 876 mm → Cave 24 Cave 25
LATO SX PE 01042				PE 01043 LATO DX

NOTE ABS 48D

Ranch	1.6 HDI 55-66-80Kw 1.6 66-80Kw	2008> 2008>		
	RIFERIMENTI ORIGINALI			
← Lungh. Tot. = 610 mm → Cave 25 Cave 24	3272CX 9661107380		3273LR 9661107280	← Lungh. Tot. = 932 mm → Cave 24 Cave 25
LATO SX CI 01010				CI 01011 LATO DX



NOTE

Clio	1.1 34Kw 1.2 40/44Kw	90>98 1.2 40/43Kw 90>98	90>98
	RIFERIMENTI ORIGINALI		
← Lungh. Tot. = 623 mm → Cave 21 Rullo Ø 30	7701349913 7701351806 7701351990	7701349939 7701351807	← Lungh. Tot. = 695 mm → Cave Int. 23 Cave 21
LATO SX RE 00101			RE 00102 LATO DX

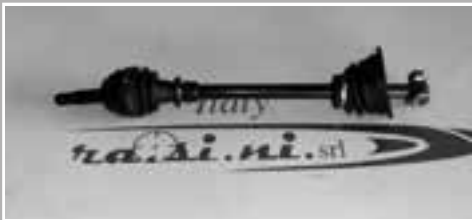
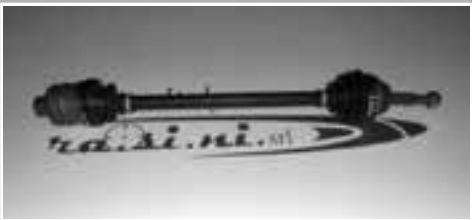

NOTE

Clio	1.1 40Kw 1.2 55Kw	90>98 1.2 43Kw 90>98 1.4 55Kw	90>98 1.7 66/68Kw 1.9 47Kw	90>98
	RIFERIMENTI ORIGINALI			
← Lungh. Tot. = 611 mm → Cave 21 Rullo Ø 30	7701349915 7701351699 7701351701 7701352223	7701349914 7701349916 7701351697 7701352224	← Lungh. Tot. = 705 mm → Cave Int. 23 Cave 21	
LATO SX RE 00103 - RE 00103/A	A = ABS 26	A = ABS 26	RE 00104 - RE 00104/A LATO DX	



NOTE Campana Ø76 - Ø86 - ABS 48D su richiesta



Clio	1.8 16V 1.8 Aut. 65/70Kw	90>98 1.8 65/70Kw 90>98 1.8 RSI 80Kw	90>98
	RIFERIMENTI ORIGINALI		
← Lungh. Tot. = 602 mm → Cave 21 Rullo Ø 30	7701349915 7701352223	7701349916 7701352224	← Lungh. Tot. = 695 mm → Cave Int. 23 Cave 21
LATO SX RE 00105 - RE 00105/A*	A = ABS 26	A = ABS 26	RE 00106 - RE 00106/A* LATO DX



NOTE ABS 26D su richiesta

Clio	1.8 16v 2.0 Williams	94/98 90>98	
	RIFERIMENTI ORIGINALI		
← Lungh. Tot. = 620 mm → Cave 21 Rullo Ø 30	7701367227	7701367623	← Lungh. Tot. = 717 mm → Cave Int. 23 Cave 21
LATO SX RE 00107 - RE 00107/A	A = ABS 26	A = ABS 26	RE 00108 - RE 00108/A LATO DX

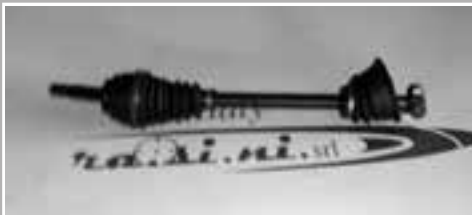
NOTE ABS 26D su richiesta

Clio	1.2 43/44Kw 1.2 16v 55Kw	98>02 98>02	1.5 DCI48/59Kw 1.6 66Kw	98>02 98>02	1.4 16v 70/72Kw 1.6 16v 79Kw	98>02 98>02	1.9 DTI 59Kw 1.9 47/48Kw	98>02 1998>
		RIFERIMENTI ORIGINALI						
← Lungh. Tot. = 625 mm → Cave 21 Rullo Ø 30		7700110484 7711135246		7700110482 7701352774		← Lungh. Tot. = 724 mm → Cave Int. 23 Cave 21		
LATO SX RE 00109 - RE 00109/A		A = ABS 26		A = ABS 26		RE 00110 - RE 00110/A LATO DX		
NOTE ABS 26D su richiesta								

Clio	1.2 16v 55Kw 1.4 16v 70/72Kw	2002> 2002>	1.5 DCI 48/59Kw 1.6 66Kw	2002> 2002>	1.6 16v 79Kw 1.9 DTI 59Kw	2002> 2002>		
		RIFERIMENTI ORIGINALI						
← Lungh. Tot. = 630 mm → Cave 21 Rullo Ø 30		8200236092* 8200240425*		8200240430*		← Lungh. Tot. = 724 mm → Cave Int. 23 Senza Foro Cave 21		
LATO SX RE 00111 - /A* - /C		A = ABS 44 C = ABS 26		A = ABS 44 C = ABS 26		RE 00112 - /A* - /C LATO DX		
NOTE								

Clio	SPORT 2.0 16v 124Kw	2000>						
		RIFERIMENTI ORIGINALI						
← Lungh. Tot. = 640 mm → Cave 23 Rullo Ø 30		7711135254 8200027881		7711135253 8200027842		← Lungh. Tot. = 735 mm → Cave Int. 23 Cave 23		
LATO SX RE 00196						RE 00197 LATO DX		
NOTE ABS 44D								

Clio	1.5 DCI 60 Kw	01>02						
		RIFERIMENTI ORIGINALI						
← Lungh. Tot. = 630 mm → Cave 23 Rullo Ø 30		8200065334		8200114426		← Lungh. Tot. = 725 mm → Cave Int. 23 Senza Foro Cave 23		
LATO SX RE 00187						RE 00188 LATO DX		
NOTE ABS 26D								

Clio

1.5 DCI 60Kw

2002>



← Lungh. Tot. = 630 mm →
Cave 23 Rullo Ø 30

LATO SX

RE 01110

RIFERIMENTI ORIGINALI

8200613824
8200236110
8200236109

8200236116



← Lungh. Tot. = 725 mm →
Cave Int. 23 Cave 23

RE 01111

LATO DX

NOTE ABS 44D

Clio

1.5 DCI 50/62Kw

2004>



← Lungh. Tot. = 610 mm →
Cave 23 Cave 26

LATO SX

RE 01144

RIFERIMENTI ORIGINALI

8200535799

8200535802
8200535800
8200362065

Fusello L/C 324mm



← Lungh. Tot. = 866 mm →
Cave 26 Cave 23

RE 01145

LATO DX

NOTE ABS 44

Clio

1.5 DCI 74Kw

2004>



← Lungh. Tot. = 600 mm →
Cave 23 Cave 26

LATO SX

RE 01205

RIFERIMENTI ORIGINALI

8200255027

8200331518

Fusello L/C 327mm



← Lungh. Tot. = 860 mm →
Cave 26 Cave 23

RE 01206

LATO DX

NOTE ABS 44

Clio

1.4 16v 72Kw
1.5 DCI 50/63/76Kw

2005>

2005>



← Lungh. Tot. = 655 mm →
Cave 23 Cave 26

LATO SX

RE 001128

RIFERIMENTI ORIGINALI

8200440187
8200499585

8200499586
820105573
391006802R

Fusello L/C 327mm



← Lungh. Tot. = 894 mm →
Cave 26 Cave 23

RE 001129

LATO DX

NOTE Fonico Ø 49

Clio

1.5 DCI 76/78Kw



← Lungh. Tot. = 648 mm →
Cave 25 Cave 26

LATO SX

RE 01230

RIFERIMENTI ORIGINALI

7701210050

8200270510
8200358164
8200455157

Fusello L/C 327



← Lungh. Tot. = 900 mm →
Cave 26 Cave 25

RE 01231

LATO DX

NOTE

Clio

1.5 DCI 55/66Kw

2012>



← Lungh. Tot. = 665 mm →
Cave 23 Cave 26

LATO SX

RE 01232

RIFERIMENTI ORIGINALI

391017355

391009101R

Fusello L/C 330mm



← Lungh. Tot. = 910 mm →
Cave 26 Cave 23

RE 01233

LATO DX

NOTE

Clio

1.2 43Kw
1.2 55/57Kw2006>
2005>

← Lungh. Tot. = 650 mm →
Cave 23 Cave 26

LATO SX

RE 01158

RIFERIMENTI ORIGINALI

8200341698

8200378880



← Lungh. Tot. = 890 mm →
Cave 26 Cave 23

RE 01159

LATO DX

NOTE Fonico Ø 49

Espace

2.0 79/81Kw
2.1 TD 65Kw84>87
84>87

← Lungh. Tot. = 685 mm →
Cave 23 Cave Int. 23

LATO SX

RE 00113 - RE 00113/A

RIFERIMENTI ORIGINALI

7701349034
7701394697
7701498921

A = ABS 48

A = ABS 48







← Lungh. Tot. = 685 mm →
Cave Int. 23 Cave 23



RE 00113 - RE 00113/A



LATO DX

NOTE ABS 48D su richiesta

Espace	2.0 79/81Kw 2.0 Quadra 87/88Kw	89>90 89>90	2.1 TD 65Kw	89>90
	RIFERIMENTI ORIGINALI			
← Lungh. Tot. = 700 mm → Cave 23 Cave Int. 23	7701351428 7701498918		7701351548*	← Lungh. Tot. = 700 mm → Cave Int. 23 Cave 23
A = ABS 48			A = ABS 48	
LATO SX RE 00114 - RE 00114/A*				RE 00114 - RE 00114/A* LATO DX
NOTE ABS 48D su richiesta				

Espace	2.0 I 87/88Kw 2.1 TD 65Kw	91>96 91>96	2.2 I - QUADRA 79/81Kw	91>96
	RIFERIMENTI ORIGINALI			
← Lungh. Tot. = 717 mm → Cave 23 Cave Int. 23	7701349734 7701351124 7701352020 7701352024		7701349940* 7701351841* 7701352021*	← Lungh. Tot. = 717 mm → Cave Int. 23 Cave 23
A = ABS 48			A = ABS 48	
LATO SX RE 00115 - RE 00115/A*				RE 00115 - RE 00115/A* LATO DX
NOTE ABS 48D su richiesta				

Espace	2.8 I V6 110Kw	91>96		
	RIFERIMENTI ORIGINALI			
← Lungh. Tot. = 722 mm → Cave 23 Cave Int. 27	7701349733 7701351122 7701352022		7701349688* 7701351121* 7701352023*	← Lungh. Tot. = 722 mm → Cave Int. 27 Cave 23
A = ABS 48			A = ABS 48	
LATO SX RE 00116 - RE 00116/A*				RE 00116 - RE 00116/A* LATO DX
NOTE ABS 48D su richiesta				

Espace	1.9 TDI 72Kw 2.0 I 16v 103Kw	1999> 97>00	2.0 84/102Kw	97>00
	RIFERIMENTI ORIGINALI			
← Lungh. Tot. = 732 mm → Cave 27 Rullo Ø 30	8200031149 7700106291		8200031144 7711135265	← Lungh. Tot. = 780 mm → Cave Int. 23 Cave 27
A = ABS 44			A = ABS 44	
LATO SX RE 00117 - RE 00117/A				RE 00118 - RE 00118/A LATO DX
NOTE ABS 44D su richiesta				

Espace

2.2 TD 83Kw

96>00



← Lungh. Tot. = 620 mm →
Cave 27 Rullo Ø 37

LATO SX **RE 00119 - RE 00119/A***

RIFERIMENTI ORIGINALI

7701470173*

7701470173*

A = ABS 44

A = ABS 44



← Lungh. Tot. = 980 mm →
Cave 39 Cave 27

RE 00120 - RE 00120/A* LATO DX**NOTE** ABS 44D su richiesta

Espace

2.2 DCI 102Kw
2.2 DCI 110Kw2006>
2002>

← Lungh. Tot. = 620 mm →
Cave 27 Rullo Ø 37

LATO SX **RE 01162**

RIFERIMENTI ORIGINALI

7711135401
8200226057
82004676797711368091
8200133289
8200436849

Fusello L/C 410mm



← Lungh. Tot. = 1004 mm →
Cave 39 Cave 27

RE 01163 LATO DX**NOTE** Fonico Ø 56,7

Espace

2.2 DCI 95Kw

00>02



← Lungh. Tot. = 595 mm →
Cave 27 Rullo Ø 37

LATO SX **RE 00198**

RIFERIMENTI ORIGINALI

7701472851
82002522457700105447
7700114056
8200169307

Fusello L/C 450mm



← Lungh. Tot. = 1005 mm →
Cave 39 Cave 27

RE 00199 LATO DX**NOTE** ABS 44D

Espace

1.9 DCI 88Kw
1.9 DCI 85Kw2002> | 2.0 125Kw
03>05 | 2.0 100Kw2005> | 2.0 T 120Kw
2002> |

2002>



← Lungh. Tot. = 660 mm →
Cave 27 Rullo Ø 37



LATO SX **RE 01001**

RIFERIMENTI ORIGINALI



771135403
8200228393
82004701338200387424
8200259911

← Lungh. Tot. = 995 mm →
Cave 39 Cave 27



RE 01002 LATO DX**NOTE**

Espace	2.2 DCi 102Kw 2.2 DCi 110Kw	2006> 3.0 DCi 130Kw 02>06 3.5 V6 177Kw	02>06 2002>
	RIFERIMENTI ORIGINALI		
← Lungh. Tot. = 644 mm → Cave 27 Cave 26	8200387408	8200387407 7711368092	← Lungh. Tot. = 1024 mm → Cave 26 Cave 27
LATO SX RE 01220			RE 01221 LATO DX



NOTE

Express	1.0 30Kw 1.1 33/34Kw	1984> 1.4 1984> 1.6 D 40Kw	1984> 1.9 D 47Kw 1984>	1988>
	RIFERIMENTI ORIGINALI			
← Lungh. Tot. = 597 mm → Cave 21 Rullo Ø 30	7701349741 7701349742 7701351195	7701349804 7701351292 7701351363	← Lungh. Tot. = 695 mm → Cave Int. 23 Cave 21	
LATO SX RE 00121			RE 00122 LATO DX	

NOTE Campana Ø76 - Ø86

Express	1.0 30Kw 1.1 33/34Kw	1984> 1.4 D 1984>	1984>
	RIFERIMENTI ORIGINALI		
← Lungh. Tot. = 610 mm → Cave 21 Rullo Ø 30	7701351162 7701349848	7701351160 7701349847	← Lungh. Tot. = 680 mm → Cave Int. 23 Cave 21
LATO SX RE 00172			RE 00173 LATO DX



NOTE

Kangoo	1.2 43Kw 1.2 16v 55Kw	98>02 1.4 55Kw 01>02 1.5 DCI 48/59Kw	1998> 1.6 16v 70Kw 01>02 1.9 DTI 59Kw	01>02 1.9 D 40/47Kw 00>02	1998>
	RIFERIMENTI ORIGINALI				
← Lungh. Tot. = 625 mm → Cave 21 Rullo Ø 30	7700110484* 7711135246*	7701352776* 7701470721*	← Lungh. Tot. = 725 mm → Cave Int. 23 Cave 21		
LATO SX RE 00123 - RE 00123/A*	A = ABS 26	A = ABS 26	RE 00124 - RE 00124/A* LATO DX		

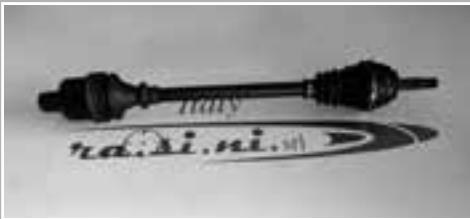

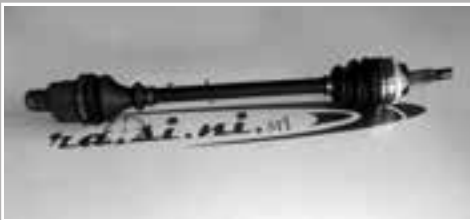
NOTE ABS 26D

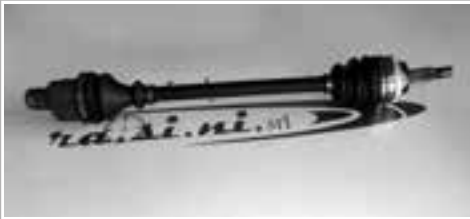

Kangoo	1.2 43Kw 1.2 16v 55Kw	11/02> 11/02>	1.4 55Kw 1.5 DCI 48/59Kw	11/02> 11/02>	1.6 16v 70Kw 1.9 DTI 59Kw	11/02> 11/02>
RIFERIMENTI ORIGINALI						
		8200240425 8200236092		8200240430 8200236096		
← Lungh. Tot. = 630 mm → Cave 21 Rullo Ø 30		A = ABS 44		A = ABS 44		← Lungh. Tot. = 724 mm → Cave Int. 23 Senza Foro Cave 21
LATO SX	RE 00125 - RE 00125/A				RE 00126 - RE 00126/A	LATO DX
NOTE ABS 44D						

Kangoo	1.5 DCI 60Kw	07/02>10/02				
RIFERIMENTI ORIGINALI						
		8200236116		8200114426 7711134959		
← Lungh. Tot. = 630 mm → Cave 23 Rullo Ø 30						← Lungh. Tot. = 725 mm → Cave Int. 23 Senza Foro Cave 23
LATO SX	RE 01110				RE 01111	LATO DX
NOTE ABS 44						



Kangoo	1.5 DCI 60Kw	2002>				
RIFERIMENTI ORIGINALI						
		7711368905 8200622834		8200236099 8200236116		
← Lungh. Tot. = 630 mm → Cave 23 Rullo Ø 30						← Lungh. Tot. = 725 mm → Cave Int. 23 Cave 23
LATO SX	RE 00187				RE 00188	LATO DX
NOTE ABS 26						

Kangoo	1.9 DCI 4X4 59Kw 1.6 16v 4X4 70Kw	2001> 2001>				
RIFERIMENTI ORIGINALI						
		8200331639 8200045471 8200144781		8200144764 8200144765		
← Lungh. Tot. = 640 mm → Cave 23 Rullo Ø 30						← Lungh. Tot. = 738 mm → Cave Int. 23 Senza Foro Cave 23
LATO SX	RE 01154				RE 01155	LATO DX
NOTE ABS 44D						

Kangoo 1.5 DCI 50-60 Kw 06/05>02/08		RIFERIMENTI ORIGINALI	
	8200535799	8200535802 8200950241 7711368570	
← Lungh. Tot. = 610 mm → Cave 23 Cave 26	Fusello L/C 273mm		← Lungh. Tot. = 866 mm → Cave 26 Cave 23
LATO SX RE 01144			RE 01145 LATO DX
NOTE ABS 44			

Kangoo 1.5 DCI 50/63/66Kw 03/2008> 1.6 64/78Kw 03/2009>		1.6 16v 72/78Kw 03/2008>	
	8200597305 8200687739	391007374R 8200597306 8200687740	
← Lungh. Tot = 683 mm → Cave 27 Cave 26	Fusello L/C 325mm		← Lungh. Tot = 922 mm → Cave 26 Cave 27
LATO SX RE 01009			RE 01010 LATO DX
NOTE Fonico Ø 56,90			

Koleos 2.0 DCi 110Kw 08>09		RIFERIMENTI ORIGINALI	
			
← Lungh. Tot. = 650 mm → Cave 29 Cave 29			← Lungh. Tot. = 982 mm → Cave 29
LATO SX NI 00135			NI 00136 LATO DX
NOTE			

Koleos 2.0 DCi 110Kw 08>09 2.0 DCi 110/127Kw 2008>		RIFERIMENTI ORIGINALI	
			
← Lungh. Tot. = 620 mm → Cave 29 Cave 29			← Lungh. Tot. = 1015 mm → Cave 29 Cave 29
LATO SX NI 00138			NI 00139 LATO DX
NOTE			

Koleos

2.0 DCi 4x4 100Kw

2008>



← Lungh. Tot. = 660 mm →
Cave 29 Cave 30

LATO SX

NI 00140

RIFERIMENTI ORIGINALI

391012360R
301012675R
391012819R
8200842365

391004255R
391005187R
8200842369

Fusello L/C 364mm



← Lungh. Tot. = 980 mm →
Cave 30 Cave 29

NI 00141

LATO DX

NOTE

Laguna

1.8 RN-RT 66/69Kw
2.0 83/84Kw>1997 Fino al telaio n. 950213
>1997

← Lungh. Tot. = 700 mm →
Cave 23 Rullo Ø 30

LATO SX

RE 00127 - RE 00127/A

RIFERIMENTI ORIGINALI

7701349994
7701352134
7711130027

7701349998
7701352141
7701352870
7711130028

A = ABS 44

A = ABS 44



← Lungh. Tot. = 745 mm →
Cave Int. 23 Cave 23

RE 00128 - RE 00128/A

LATO DX

NOTE ABS 44D su richiesta

Laguna

1.8 RN-RT 66Kw
2.0 RN-RXE 83/84Kw1995> Dal telaio n. 950214
1995>

← Lungh. Tot. = 702 mm →
Cave 21 Rullo Ø 30

LATO SX

RE 00129 - RE 00129/A

RIFERIMENTI ORIGINALI

7701352386
7701354993
7701468887
7711130045

7701349997
7701352385
7711130028
7711130044

A = ABS 44

A = ABS 44



← Lungh. Tot. = 748 mm →
Cave Int. 23 Cave 21

RE 00130 - RE 00130/A

LATO DX

NOTE ABS 44D su richiesta

Laguna

2.0 S 16v 102Kw

95>97



← Lungh. Tot. = 660 mm →
Cave 23 Rullo Ø 30

LATO SX

RE 00135 - RE 00135/A

RIFERIMENTI ORIGINALI

7701352345*
7701468642*

7701352348*
7701468647*

A = ABS 44

A = ABS 44





← Lungh. Tot. = 795 mm →
Cave Int. 23 Cave 23



RE 00136 - RE 00136/A

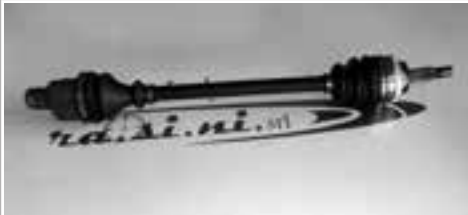

LATO DX



NOTE ABS 44D su richiesta



Laguna	1.6 16v 79Kw 1.8 16v 88Kw	97>01 1.9 DTI 72Kw 97>01 2.0 16v 103Kw	98>01 97>01
	RIFERIMENTI ORIGINALI		
← Lungh. Tot. = 705 mm → Cave 23 Rullo Ø 30	8200031137	8200024622	← Lungh. Tot. = 745 mm → Cave Int. 23 Cave 23
LATO SX RE 00133			RE 00134 LATO DX
NOTE Fonico Ø 56,7			

Laguna	2.2 D 12v	94>01	
	RIFERIMENTI ORIGINALI		
← Lungh. Tot. = 660 mm → Cave 23 Rullo Ø 30	7701349992 7701352129*	7701352427 7701352428*	← Lungh. Tot. = 800 mm → Cave Int. 23 Cave 23
LATO SX RE 01112 - RE 01112/A	A = ABS 44	A = ABS 44	RE 01113 - RE 01113/A LATO DX
NOTE ABS 44D su richiesta			

Laguna	2.2 DT 83Kw 3.0 V6	1996> 1996>	
	RIFERIMENTI ORIGINALI		
← Lungh. Tot. = 595 mm → Cave 23 Rullo Ø 37	7701352128 7701352493	7701349999 7701352495	← Lungh. Tot. = 955 mm → Cave 39 Cave 23
LATO SX RE 01116 - RE 01116/A	A = ABS 44	A = ABS 44	RE 01117 - RE 01117/A LATO DX
NOTE ABS			



Laguna	1.9 DCI 71/77/81/88Kw	2001>	
	RIFERIMENTI ORIGINALI		
← Lungh. Tot. = 635 mm → Cave 27 Rullo Ø 37	8200079913	8200079912	← Lungh. Tot. = 970 mm → Cave 39 Cave 27
LATO SX RE 01120		Fusello L/C 363mm Ø 29,70	RE 01121 LATO DX
NOTE Fonico Ø 56,7			



Laguna	1.6 16v 79/82Kw 1.8 16v 85/88/89Kw	2001> 1.9 DCI 77Kw 2001> 2.0 16v	2001> 2001>
	RIFERIMENTI ORIGINALI		
← Lungh. Tot. = 725 mm → Cave 27 Rullo Ø 30	8200014111	8200035673	← Lungh. Tot. = 800 mm → Cave Int. 23 Cave 27
LATO SX RE 01118			RE 01119 LATO DX
NOTE Fonico Ø 56,7			



Laguna	1.9 DCI 79Kw	99>01	
	RIFERIMENTI ORIGINALI		
← Lungh. Tot. = 620 mm → Cave 23 Rullo Ø 37	7700112506 7711135196 8200032891	7700112507 7700112511 8200032887 8200063808	← Lungh. Tot. = 930 mm → Cave 39 Cave 23
LATO SX RE 01130			RE 01131 LATO DX
NOTE Fonico Ø 56,7			



Laguna	2.0 120/125Kw	2003>	
	RIFERIMENTI ORIGINALI		
← Lungh. Tot. = 664 mm → Cave 27 Cave 26	8200387559	8200387558 Fusello L/C 317	← Lungh. Tot. = 940 mm → Cave 26 Cave 27
LATO SX RE 01216			RE 01217 LATO DX
NOTE			

Laguna	2.0 DCI 127/131Kw 2.0 DCI 96Kw	2008> 2008Z	
	RIFERIMENTI ORIGINALI		
← Lungh. Tot. = 635 mm → Cave 27 Cave 39		8200659627 Fusello L/C 367mm	← Lungh. Tot. = 985 mm → Cave 39 Cave 27
LATO SX RE 01180			RE 1230 LATO DX
NOTE			

Laguna	1.5 DCI 81Kw	2007>		
 <p>← Lungh. Tot. = 692 mm → Cave 27 Cave 26</p> <p>LATO SX RE 01114</p>	RIFERIMENTI ORIGINALI		 <p>← Lungh. Tot. = 943 mm → Cave 26 Cave 27</p> <p>RE 01115 LATO DX</p>	
	8200538941	8200676172		
NOTE Fonico Ø 57				

Laguna	2.0 DCI 110/127Kw	2007>		
 <p>← Lungh. Tot. = 635 mm → Cave 27 Cave 39</p> <p>LATO SX RE 01180</p>	RIFERIMENTI ORIGINALI		 <p>← Lungh. Tot. = 970 mm → Cave 39 Cave 27</p> <p>RE 01181 LATO DX</p>	
	8200618182 82006599626 8201235787	8200618168 8200786810		Fusello L/C 342mm
NOTE Fonico Ø 57				

Master	2.0 2.0 Diesel	>1982 >1982	2.4 Diesel	>1982
 <p>← Lungh. Tot. = 886 mm → Cave 32 Cave 31</p> <p>LATO SX RE 00182</p>	RIFERIMENTI ORIGINALI		 <p>← Lungh. Tot. = 886 mm → Cave 31 Cave 32</p> <p>RE 00182 LATO DX</p>	
	7701462289			
NOTE				

Master	2.0 2.1 D	1983> 1983>	2.4 D	1983>
 <p>← Lungh. Tot. = 825 mm → Cave 32 Cave Int. 27</p> <p>LATO SX RE 00137</p>	RIFERIMENTI ORIGINALI		 <p>← Lungh. Tot. = 825 mm → Cave Int. 27 Cave 32</p> <p>RE 00137 LATO DX</p>	
	7701463343 7701499223			
NOTE				

Master

2.2 DCI 66Kw

2000>



← Lungh. Tot. = 665 mm →
Cave 28 Rullo Ø 37

LATO SX **RE 00185 - RE 00185/A**

RIFERIMENTI ORIGINALI

7700102979
77111352787711135531
8200026912
8200169271
8200169277

A = ABS 51

Fusello L/C 421 m
A = ABS 51

← Lungh. Tot. = 1130 mm →
Cave 39 Cave 28

RE 00186 - RE 00186/A LATO DX**NOTE** ABS 51D su richiesta

Master

2.5 D 59Kw
2.8 TDI 84Kw97>00
97>00

← Lungh. Tot. = 670 mm →
Cave 28 Rullo Ø 37

LATO SX **RE 01183 - RE 01183/A**

RIFERIMENTI ORIGINALI

7700102978
7700102998
8200052428
8200178618
82004855767711135280
7700102981

A = ABS 51

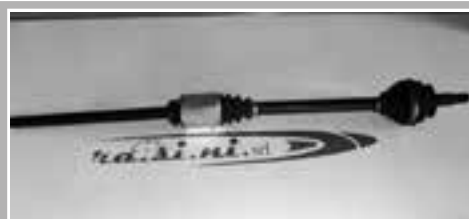
Fusello L/C430mm
A = ABS 51

← Lungh. Tot. = 1120 mm →
Cave 39 Cave 28

RE 00184 - RE 00184/A LATO DX**NOTE** ABS 51D su richiesta

Master

1.9 DCI 60Kw
1.9 DTI 59Kw2001>
2000>

← Lungh. Tot. = 645 mm →
Cave 28 Rullo Ø 37

LATO SX **RE 01170 - RE 01170/A**

RIFERIMENTI ORIGINALI

8200052421
7711135530
8200169273
7711135532
77014730108200052420
8200169272
7701473013

A = ABS 51

Fusello L/C 390 m
A = ABS 51

← Lungh. Tot. = 1152 mm →
Cave 39 Cave 28

RE 00195 - RE 00195/A LATO DX**NOTE** ABS 51D su richiesta

Master

2.5 DCI 73/84Kw

2002>



← Lungh. Tot. = 665 mm →
Cave 28 Rullo Ø 37

LATO SX **RE 01185**

RIFERIMENTI ORIGINALI

8200178624



8200169288
8200178625
8200499895



Fusello L/C 431 m







← Lungh. Tot. = 1140 mm →
Cave 39 Cave 28

RE 01123 LATO DX**NOTE** ABS 51D

Master 2.8 DTI 84Kw		2000>	
 <p>← Lungh. Tot. = 668 mm → Cave 28 Rullo Ø 37</p>	RIFERIMENTI ORIGINALI		 <p>← Lungh. Tot. = 1127 mm → Cave 39 Cave 28</p>
	8200485576	8200052426	
<p>A = ABS 51</p> <p>Fusello L/C 435 m A = ABS 51</p>			
<p>LATO SX RE 01188 - RE 01188/A</p>			<p>RE 01189 - RE 01189/A LATO DX</p>
NOTE ABS 51D			



Master 3.0 DCI 100Kw		2003>	
 <p>← Lungh. Tot. = 690 mm → Cave 28 Cave 39</p>	RIFERIMENTI ORIGINALI		 <p>← Lungh. Tot. = 1130 mm → Cave 39 Cave 28</p>
	8200299844	8200164149	
<p>Fusello L/C536mm</p>			
<p>LATO SX RE 01150</p>			<p>RE 01151 LATO DX</p>
NOTE ABS 51D			

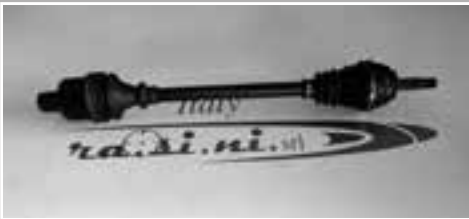

Master 2.5 DCI 74/88Kw		2006>	
 <p>← Lungh. Tot. = 701 mm → Cave 28 Cave 39</p>	RIFERIMENTI ORIGINALI		 <p>← Lungh. Tot. = 1116 mm → Cave 39 Cave 28</p>
	7701351172 8200414939 8200776522 820187929	39101-00Q0D 8200414937	
<p>Fusello L/C428mm</p>			
<p>LATO SX RE 01193</p>			<p>RE 01194 LATO DX</p>
NOTE ABS 51D			

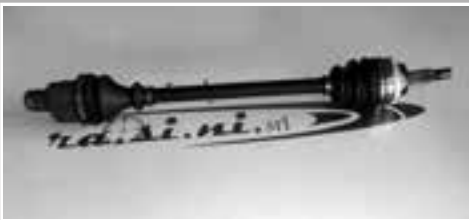
Master 2.3 DCI 74Kw 2.3 DCI 81Kw		2011> 2014>	2.3 DCI 92/100/107/110/120Kw 2011>
 <p>← Lungh. Tot. = 745 mm → Cave 31 Cave 39</p>	RIFERIMENTI ORIGINALI		 <p>← Lungh. Tot. = 1075 mm → Cave 39 Cave 31</p>
	301012360R 301012675R 391012849R 8200842365	391004255R 391005187R 8200842369	
<p>Fusello L/C 364mm</p>			
<p>LATO SX RE 01214</p>			<p>RE 01215 LATO DX</p>
NOTE			

Megane	1.8 16v 85Kw 1.9 DCI 75Kw	99>01 2.0 I 84Kw 00>01	1996>
	RIFERIMENTI ORIGINALI		
← Lungh. Tot. = 656 mm →	7700111920 8200064731	7700111918 7701352421 7701470616 7711135206	← Lungh. Tot. = 750 mm →
LATO SX	RE 00189		RE 00147 LATO DX
NOTE ABS 44D			

Megane	1.8 16v 85Kw 2.0 16v 102Kw	2001> 2001>	
	RIFERIMENTI ORIGINALI		
← Lungh. Tot. = 655 mm → Cave 23 Rullo Ø 30	7700111920 8200064731	8200095539	← Lungh. Tot. = 750 mm → Cave Int.23 Cave 23
LATO SX	RE 01126		RE 01127 LATO DX
NOTE			

Megane / Megane Cabriolet	1.4 16v 70Kw 1.6 16v	1999> Cabrio 1.4 16v 70kw 1996> Cabrio 1.6 16v 79Kw	1999> Cabrio 2.0 I 80/84Kw 1999>	1996>
	RIFERIMENTI ORIGINALI			
← Lungh. Tot. = 648 mm → Cave 21 Rullo Ø 30	7701352596 7700111079 3200030175 7701352413 7701352416	7700105485 7700111811 7700111820 7700873322	← Lungh. Tot. = 745 mm → Cave Int. 23 Cave 21	
LATO SX	RE 00138 - RE 00138/A	A = ABS 44	RE 00139 - RE 00139/A LATO DX	
NOTE ABS 44D su richiesta				

Megane / Megane Cabriolet	1.4 16v 70Kw 1.4 55Kw	1999> 1.6 66Kw 1996> 1.6 I 55Kw	1996> 1.9 D 47Kw 96>99 Cabrio 1.6 66Kw	96>99
	RIFERIMENTI ORIGINALI			
← Lungh. Tot. = 650 mm → Cave 21 Rullo Ø 30	7701468839 7701352595 7701469374 7701352596 7701352471	7701352422 7701352598 7701469375 7701468840	← Lungh. Tot. = 742 mm → Cave Int. 23 Cave 21	
LATO SX	RE 00140 - RE 00140/A	A = ABS 44	RE 00141 - RE 00141/A LATO DX	
NOTE ABS 44D su richiesta				

Megane / Megane Cabriolet

1.8 16v 85Kw
Cabrio 2.0 16v 103Kw

2001>
2001>



← Lungh. Tot. = 655 mm →
Cave 23 Rullo Ø 30

LATO SX **RE 01126**

RIFERIMENTI ORIGINALI

7700111920
8200064731

8200095539

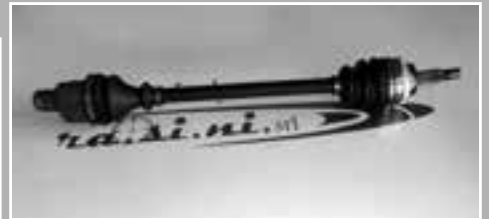

← Lungh. Tot. = 750 mm →
Cave Int.23 Cave 23

RE 01127 LATO DX

NOTE ABS 44D

Megane / Megane Cabriolet

1.6 16v 79Kw
Cabrio 1.6 16v

1999>
1999>



← Lungh. Tot. = 655 mm →
Cave 21 Rullo Ø 30

LATO SX **RE 01124 - RE 01124/A**

RIFERIMENTI ORIGINALI

7701352471
8200090175
7700111079

7700111077
8200168513

A = ABS 44

A = ABS 44



← Lungh. Tot. = 751 mm →
Cave Int.23 Senza Foro Cave 21

RE 01125 - RE 01125/A LATO DX

NOTE ABS 44

Megane / Megane Classic

1.9 DCI 75Kw
1.9 DTI 59Kw

2001>
2001>

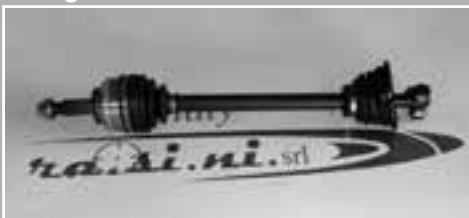

← Lungh. Tot. = 656 mm →
Cave 23 Rullo Ø 30

LATO SX **RE 00189**

RIFERIMENTI ORIGINALI

7700111920
8200064731

8200095539



← Lungh. Tot. = 750 mm →
Cave Int. 23 Cave 23

RE 00190 LATO DX

NOTE ABS 44D

Megane Classic

1.9 DT 66Kw
1.9 DTI 72Kw

1996> 1.9 DTI 59Kw
1997> 2.0 16v 108Kw

99>01
1996>



← Lungh. Tot. = 656 mm →
Cave 23 Rullo Ø 30

LATO SX **RE 00189**

RIFERIMENTI ORIGINALI

7700111920
8200064731

7700111918
7701352421
7701470616
7711135206



← Lungh. Tot. = 750 mm →
Cave Int.23 Senza Foro Cave 23

RE 00147 LATO DX

NOTE ABS 44D

**Megane Classic /
Megane Coach**Classic 1.4 16v 70Kw
Classic 1.6 16v 79Kw1999>
1996>Coach 1.4 16v 70kw
Coach 1.6 16v 79Kw1999>
1999>

Coach 2.0 I 80/84Kw

1996>

← Lungh. Tot. = 648 mm →
Cave 21 Rullo Ø 30LATO SX **RE 00138 - RE 00138/A**

RIFERIMENTI ORIGINALI

7701352596

7700105485
7700111811
7700111820
7700873322

A = ABS 44

A = ABS 44

← Lungh. Tot. = 745 mm →
Cave Int. 23 Cave 21**RE 00139 - RE 00139/A** LATO DX

NOTE ABS 44D su richiesta

**Megane Classic /
Megane Coach**1.4 16v 70Kw
1.4 55Kw1999>
1996>1.6 66Kw
1.6 I 55Kw1996>
96>991.9 D 47Kw
Cabrio 1.6 66Kw

96>99

← Lungh. Tot. = 650 mm →
Cave 21 Rullo Ø 30LATO SX **RE 00140 - RE 00140/A**

RIFERIMENTI ORIGINALI

7701468839
7701352595
7701469374
7701352596
77013524717701352422
7701352598
7701469375
7701468840

A = ABS 44

A = ABS 44

← Lungh. Tot. = 742 mm →
Cave Int. 23 Cave 21**RE 00141 - RE 00141/A** LATO DX

NOTE ABS 44D su richiesta

**Megane Coach /
Megane Cabriolet**2.0 16v 108Kw
2.0 16v 103Kw1996>
99>01← Lungh. Tot. = 656 mm →
Cave 23 Rullo Ø 30LATO SX **RE 00189**

RIFERIMENTI ORIGINALI

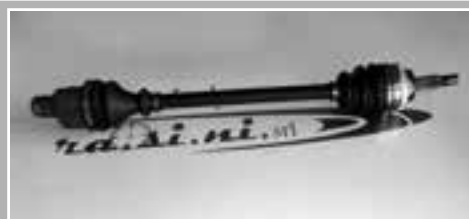
7700111920
82000647317700111918
7701352421
7701470616
7711135206← Lungh. Tot. = 750 mm →
Cave Int.23 Senza Foro Cave 23**RE 00147** LATO DX

NOTE ABS 44D

**Megane Coach /
Megane SW**Coach 2.0 16v 103Kw
SW 1.8 16v 85Kw2001>
2001>← Lungh. Tot. = 655 mm →
Cave 23 Rullo Ø 30LATO SX **RE 01126**

RIFERIMENTI ORIGINALI

7700111920
8200064731

8200095539

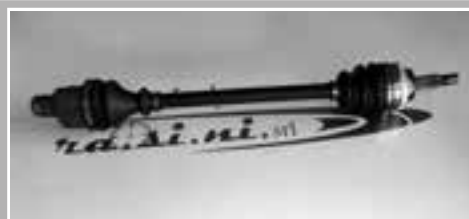
← Lungh. Tot. = 750 mm →
Cave Int.23 Cave 23**RE 01127** LATO DX

NOTE ABS 44D

Megane Coupé / Megane Scenic Coupé 1.6 16v
Scenic 1.4 16v

1999> |
1999> |



← Lungh. Tot. = 655 mm →
Cave 21 Rullo Ø 30

LATO SX **RE 01124 - RE 01124/A**

RIFERIMENTI ORIGINALI

A = ABS 44

A = ABS 44

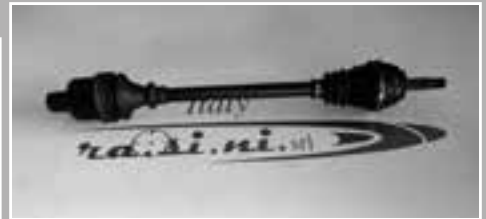

← Lungh. Tot. = 751 mm →
Cave Int.23 Senza Foro Cave 21

RE 01125 - RE 01125/A LATO DX

NOTE ABS 44

Megane Scenic 1.4 I 55Kw
1.6 66Kw

1997> | 1.6 I
97>98 | 1.9 D 47Kw

97>98 | 1.9 DT 66Kw

97>99



← Lungh. Tot. = 650 mm →
Cave 21 Rullo Ø 30

LATO SX **RE 00140 - RE 00140/A**

RIFERIMENTI ORIGINALI

7701468839
7701352595
7701469374
7701352596
7701352471

7701352422
7701352598
7701469375
7701468840

A = ABS 44

A = ABS 44



← Lungh. Tot. = 742 mm →
Cave Int. 23 Cave 21

RE 00141 - RE 00141/A LATO DX

NOTE ABS 44D su richiesta

Megane Scenic 1.6 16v 79Kw
1.9 DTI 72Kw

98>99 | 2.0 80/84Kw
1997>

98>99 |



← Lungh. Tot. = →
Cave 23 Rullo Ø 30

LATO SX **RE 00189**

RIFERIMENTI ORIGINALI

7700111920
8200064731

7700111918
7701352421
7701470616
7711135206



← Lungh. Tot. = →
Cave Int.23 Senza Foro Cave 23

RE 00147

LATO DX

NOTE ABS 44D

Megane Scenic 1.6 16v 79Kw
2.0 I 80/84Kw

97>98 |
97>98 |



← Lungh. Tot. = 654 mm →
Cave 23 Rullo Ø 30

LATO SX **RE 00144 - RE 00144/A**

RIFERIMENTI ORIGINALI

7701352414

7701352421

A = ABS 44

A = ABS 44



← Lungh. Tot. = 750 mm →
Cave Int. 23 Cave 23

RE 00145 - RE 00145/A LATO DX

NOTE ABS 44D su richiesta

Megane Scenic

1.9 DTI 72Kw

99>03



← Lungh. Tot. = 702 mm →
Cave 23 Rullo Ø 30

LATO SX

RE 01166

RIFERIMENTI ORIGINALI

7701352732

7701352731



← Lungh. Tot. = 745 mm →
Cave Int. 23 Cave 23

RE 01167

LATO DX

NOTE ABS 44D

Megane Scenic /
Megane SWScenic 1.6 66Kw
Scenic 1.6 I 55Kw1998> SW 1.4 16v 70kw
1998> SW 1.6 16v 79Kw1999>
1999>

← Lungh. Tot. = 648 mm →
Cave 21 Rullo Ø 30

LATO SX

RE 00138 - RE 00138/A

RIFERIMENTI ORIGINALI

7701352596
77013524137700105485
7700111811
7700111820
7700873322

A = ABS 44

A = ABS 44



← Lungh. Tot. = 745 mm →
Cave Int. 23 Cave 21

RE 00139 - RE 00139/A

LATO DX

NOTE ABS 44D su richiesta

Megane Scenic
4x41.9 DCI 75Kw
2.0 16v 102Kw2000>
2000>

← Lungh. Tot. = 680 mm →
Cave 23 Rullo Ø 30

LATO SX

RE 01160

RIFERIMENTI ORIGINALI

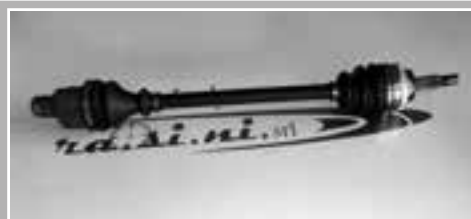

← Lungh. Tot. = 780 mm →
Cave Int.23 Cave 23

RE 01161

LATO DX

NOTE ABS 44D

Megane Scenic X
mod. III

1.6 DCi 16v 96Kw

11>12

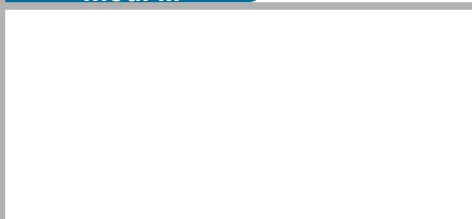

← Lungh. Tot. = 665 mm →
Cave 27 Cave 39

LATO SX

RE 01224

RIFERIMENTI ORIGINALI

8200725512

391001702R

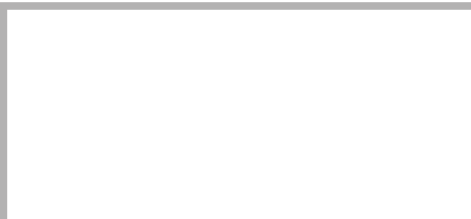

← Lungh. Tot. = 975 mm →
Cave 39 Cave 27

RE 01225

LATO DX

NOTE

Megane Scenic X mod. III		2.0 DCi 110/118Kw	2012>	
RIFERIMENTI ORIGINALI				
← Lungh. Tot. = 640 mm → Cave 27 Cave 39				← Lungh. Tot. = 987 mm → Cave 39 Cave 27
LATO SX	RE 01222			RE 01223 LATO DX

NOTE

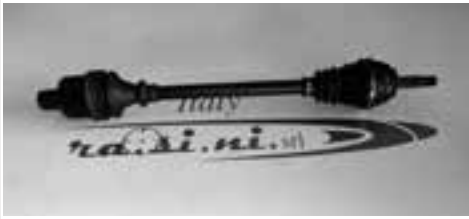
Megane SW		1.4 16v 70Kw 1.4 55Kw	1999> 1996>	1.6 66Kw 1.9 D 47Kw	1996> 1996>
RIFERIMENTI ORIGINALI					
		7701468839 7701352595 7701469374 7701352596 7701352471		7701352422 7701352598 7701469375 7701468840	
← Lungh. Tot. = 650 mm → Cave 21 Rullo Ø 30		A = ABS 44		A = ABS 44	← Lungh. Tot. = 742 mm → Cave Int. 23 Cave 21
LATO SX	RE 00140 - RE 00140/A				RE 00141 - RE 00141/A LATO DX

NOTE ABS 44D su richiesta

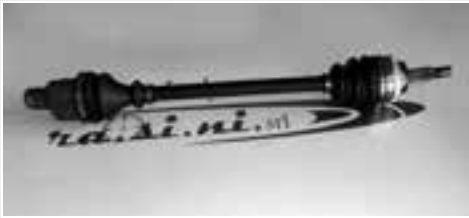
Megane SW		1.8 16v 85Kw 1.9 DCI 75Kw	99>01 99>01	1.9 DTI 72Kw 1.9 DTI 59Kw	1997> 99>01
RIFERIMENTI ORIGINALI					
		7700111920 8200064731		7700111918 7701352421 7701470616 7711135206	
← Lungh. Tot. = → Cave 23 Rullo Ø 30					← Lungh. Tot. = → Cave Int.23 Senza Foro Cave 23
LATO SX	RE 00189				RE 00147 LATO DX

NOTE ABS 44D

Megane SW		1.9 DCI 75Kw 1.9 DTI 59Kw	2001> 2001>	
RIFERIMENTI ORIGINALI				
		7700111920 8200064731		8200095539
← Lungh. Tot. = 656 mm → Cave 23 Rullo Ø 30				
LATO SX	RE 00189			RE 00190 LATO DX

NOTE ABS 44D

Megane II

1.5 DCI 60/63/74/78Kw
1.6 16v 82/83Kw2003>
2002>← Lungh. Tot. = 679 mm →
Cave 23 Cave 26

LATO SX

RE 00191

RIFERIMENTI ORIGINALI

8200379236
8200626043

8200626038

Fusello 326mm

← Lungh. Tot. = 915 mm →
Cave 26 Cave 23

RE 00192

LATO DX

NOTE Fonico Ø 49

Megane II

1.5 DCI 74/76/78Kw
6 speed

2003>

← Lungh. Tot. = 662 mm →
Cave 25 Cave 26

LATO SX

RE 01140

RIFERIMENTI ORIGINALI

7711135954
8200330413
8200375537
8200432516

8200472158

Fusello 325mm

← Lungh. Tot. = 912 mm →
Cave 26 Cave 25

RE 01141

LATO DX

NOTE Fonico Ø 52,7

Megane II

1.9 DCI 68/81/88/96Kw
6 speed

2003>

2.0 16v Turbo

04>08

← Lungh. Tot. = 640 mm →
Cave 25 Cave 39

LATO SX

RE 01132

RIFERIMENTI ORIGINALI

7711135420
82001980168200198015
8200436366
8200790517

Fusello L/C 348mm

← Lungh. Tot. = 935 mm →
Cave 39 Cave 25

RE 01133

LATO DX

NOTE Fonico Ø 52,7

Megane II

1.5 DCI 63/70/78/81Kw

2009>

← Lungh. Tot. = 685 mm →
Cave 25 Cave 26

LATO SX

RE 01007

RIFERIMENTI ORIGINALI

7711497441
8200788672
8200847584
82013536278200725502
8200974685
391006777R

Fusello L/C 338mm

← Lungh. Tot. = 945 mm →
Cave 26 Cave 25



RE 01008

LATO DX

NOTE Fonico Ø 49

Megane II 1.9 DCi 85Kw C. Aut. 02>08		RIFERIMENTI ORIGINALI	
		8200531910	8200486092
← Lungh. Tot. = 685 mm → Cave 25 Cave 26			← Lungh. Tot. = 792 mm → Cave 26 Cave 25
LATO SX	RE 01226		RE 01227 LATO DX

NOTE

Megane II 1.9 DCI 2006>		RIFERIMENTI ORIGINALI	
			
← Lungh. Tot. = 665 mm → Cave 25 Cave 39			← Lungh. Tot. = 904 mm → Cave 39 Cave 25
LATO SX	RE 01142		RE 01143 LATO DX

NOTE Fonico Ø 52,7

Megane II 1.6 81Kw 5 marce 2008>		RIFERIMENTI ORIGINALI	
		391013387R 8200788674	391009002D 8200725500
← Lungh. Tot. = 637 mm → Cave 25 Cave 26		Fusello L/C 327mm	← Lungh. Tot. = 933 mm → Cave 26 Cave 25
LATO SX	RE 01005		RE 01006 LATO DX



NOTE Fonico Ø 49



Megane II / Scenic Gran Scenic 1.9 DCi 96Kw C. Aut. 05>08		RIFERIMENTI ORIGINALI	
		8200531910	8200486092
← Lungh. Tot. = 685 mm → Cave 25 Cave 26			← Lungh. Tot. = 792 mm → Cave Int. 26 Cave 25
LATO SX	RE 01226		RE 01227 LATO DX

NOTE

Megane III		1.6 DCi 96Kw 1.9 DCi 96Kw	2011> 2009>	
RIFERIMENTI ORIGINALI				
		8200725512	8200725513 8200383708	
← Lungh. Tot. = 665 mm → Cave 27 Cave 39		Fusello L/C 350mm		← Lungh. Tot. = 953 mm → Cave 39 Cave 27
LATO SX	RE 01224		RE 01225	LATO DX
NOTE				

Megane III		2.0 DCi 110/118/120Kw	2009>	
RIFERIMENTI ORIGINALI				
		8200725514	09864R 8200974682	
← Lungh. Tot. = 640 mm → Cave 27 Cave 39		Post. L.Tot.45 Fusello L/C 380mm		← Lungh. Tot. = 987 mm → Cave 39 Cave 27
LATO SX	RE 01222		RE 01223	LATO DX
NOTE				

Modus		1.5 DCi 50/63/76Kw 1.4 16v 73Kw	2004> 2004>	
RIFERIMENTI ORIGINALI				
		8200440187 8200499585	8200499586 8200618111	
← Lungh. Tot. = 655 mm → Cave 23 Cave 26		Fusello 327mm		← Lungh. Tot. = 894 mm → Cave 26 Cave 23
LATO SX	RE 01128		RE 01129	LATO DX
NOTE Fonico Ø 49				

Modus		1.2 48/55Kw 1.2 16v 74Kw	2005> 2007>	
RIFERIMENTI ORIGINALI				
		8200330413 8200341698	8200472158	
← Lungh. Tot. = 650 mm → Cave 23 Cave 26		Fusello 276mm		← Lungh. Tot. = 890 mm → Cave 26 Cave 23
LATO SX	RE 01158		RE 01159	LATO DX
NOTE Fonico Ø 49				

R4 - R5 - R6

Tutti i modelli dal 1972 al 1984



← Lungh. Tot. = 665 mm →
Cave 23 Cave 22

LATO SX

RE 00148

RIFERIMENTI ORIGINALI

7701348098
7701448098
7701498698



← Lungh. Tot. = 665 mm →
Cave 22 Cave 23

RE 00148

LATO DX

NOTE

R9 - 11

1.2 40Kw
1.4 Turbo 77Kw

88>90 | 1.7 59Kw
84>90

84>90



← Lungh. Tot. = 645 mm →
Cave 21 Rullo Ø 30

LATO SX

RE 00149

RIFERIMENTI ORIGINALI

7701349692
7701351127

7701349691
7701351126



← Lungh. Tot. = 715 mm →
Cave 23 Cave 21

RE 00150

LATO DX

NOTE

R9 - 11

1.1 35Kw
1.4 44/53Kw

81>90 | 1.6 TD 40Kw
81>90

83>90



← Lungh. Tot. = 630 mm →
Cave 21 Rullo Ø 30

LATO SX

RE 00151

RIFERIMENTI ORIGINALI

7701351020
7701498958
7701351207

7701349660
7701498957



← Lungh. Tot. = 730 mm →
Cave 23 Cave 21

RE 00152

LATO DX

NOTE

R19

1.4 43Kw
1.7 54/55Kw

1988> | 1.8 16V 79/81Kw
1988> | 1.9 D 47Kw

1988> | 1.9 TD
1988>

1991>



← Lungh. Tot. = 640 mm →
Cave 21 Rullo Ø 30

LATO SX

RE 00153 - RE 00153/A

RIFERIMENTI ORIGINALI

7701349880
7701351484
7701349974

7701349972
7701351480
7701351479

A = ABS 48

A = ABS48



← Lungh. Tot. = 735 mm →
Cave Int. 23 Cave 21

RE 00154 - RE 00154/A

LATO DX

NOTE ABS 48D su richiesta solo 1.9TD e 1.8 16v

R19

1.2
1.4 43Kw1988>
1988>← Lungh. Tot. = 650 mm →
Cave 21 Rullo Ø 30

LATO SX

RE 00155

RIFERIMENTI ORIGINALI

7701349879
77013514837701351126
7701351478← Lungh. Tot. = 722 mm →
Cave Int. 23 Cave 21

RE 00156

LATO DX

NOTE

R21

1.4 43Kw
1.7 55Kw1986> | 1.9 D 47Kw
1986>

1989>

← Lungh. Tot. = 650 mm →
Cave 21 Rullo Ø 30

LATO SX

RE 00157

RIFERIMENTI ORIGINALI

7701349785
77013512667701349786
7701351267← Lungh. Tot. = 745 mm →
Cave Int. 23 Cave 21

RE 00158

LATO DX

NOTE

R21

2.0 GTX-RX-RXE-TXE-NEVADA | 2.0 NEVADA GTX 4X4-TXI 12V | 2.1 Diesel | 1986>
1986> | 1986> | 2.2 Nevada 4X4 | 1986>← Lungh. Tot. = 696 mm →
Cave 23 Cave Int. 23

LATO SX

RE 00159

RIFERIMENTI ORIGINALI

7701349839
7701351264
7701352025← Lungh. Tot. = 696 mm →
Cave Int. 23 Cave 23

RE 00159

LATO DX

NOTE

R25

2.0 74Kw
2.0 12v 89Kw1983> | 2.1 D-TD 46/63Kw
1983> | 2.2 89Kw1983>
1983>← Lungh. Tot. = 717 mm →
Cave 23 Cave Int. 23

LATO SX

RE 00170 - RE 00170/A

RIFERIMENTI ORIGINALI

7701349940
7701352021

A = ABS 48



A = ABS 48

← Lungh. Tot. = 717 mm →
Cave Int. 23 Cave 23



RE 00170 - RE 00170/A

LATO DX



NOTE ABS 48D su richiesta

R25	2.2 GTX 79Kw 2.5 V6 Turbo 133/151Kw	1983> 1983>	2.7 V6 104Kw 2.8 V6 115Kw	1983> 1983>
	RIFERIMENTI ORIGINALI			
← Lungh. Tot. = 722 mm → Cave 23 Cave Int. 27	7701349733 7701352022		← Lungh. Tot. = 722 mm → Cave Int. 27 Cave 23	
LATO SX RE 00171 - RE 00171/A	A = ABS 48	A = ABS 48	RE 00171 - RE 00171/A LATO DX	



NOTE ABS 48D su richiesta

Safrane	2.0 77Kw 2.0 12v 97Kw	1992> 1992>	2.1 TD 65/66Kw 2.2 79/101Kw	1992> 1992>
	RIFERIMENTI ORIGINALI			
← Lungh. Tot. = 600 mm → Cave 23 Rullo Ø 37			← Lungh. Tot. = 541 mm → Rullo Ø 37 Cave 23	
LATO SX RE 00160 - RE 00160/A	A = ABS 30	A = ABS 30	RE 00161 - RE 00161/A LATO DX	



NOTE ABS 30D su richiesta

Safrane	2.5 Turbo Diesel 83Kw	92>96		
	RIFERIMENTI ORIGINALI			
← Lungh. Tot. = 584 mm → Cave 23 Rullo Ø 37			← Lungh. Tot. = 1000 mm → Cave 39 Cave 23	
LATO SX RE 00164 - RE 00164/A	A = ABS 30	A = ABS 30	RE 00165 - RE 00165/A LATO DX	

NOTE ABS 30D su richiesta

Safrane	3.0 I V6 123Kw 3.0 I V6 4x4 123Kw	92>96 92>96		
	RIFERIMENTI ORIGINALI			
← Lungh. Tot. = 598 mm → Cave 23 Rullo Ø 37			← Lungh. Tot. = 985 mm → Cave 39 Cave 23	
LATO SX RE 00166 - RE 00166/A			RE 00167 - RE 00167/A LATO DX	



NOTE ABS 30D su richiesta

Super 5	1.0 30Kw 1.1 33/34Kw	1984> 1.2 40Kw 1984> 1.4 43Kw	1984>
 <p>← Lungh. Tot. = 610 mm → Cave 21 Rullo Ø 30</p>	RIFERIMENTI ORIGINALI		 <p>← Lungh. Tot. = 680 mm → Cave Int. 23 Cave 21</p>
	7701349848 7701351162	7701349847 7701349726	
LATO SX	RE 00172		RE 00173 LATO DX

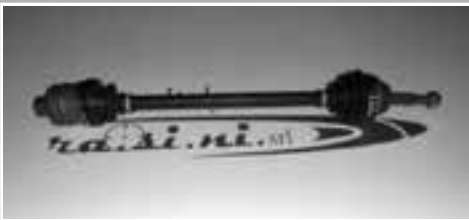

NOTE

Super 5	1.4 GT Turbo 85/88Kw 1.6 D 40Kw	1984> 1.7 68/69Kw 1984>	1984>
 <p>← Lungh. Tot. = 600 mm → Cave 21 Rullo Ø 30</p>	RIFERIMENTI ORIGINALI		 <p>← Lungh. Tot. = 695 mm → Cave Int. 23 Cave 21</p>
	7701349803 7701349945 7701351195	7701349771 7701470304 7701351192	
LATO SX	RE 00174		RE 00175 LATO DX



NOTE

Trafic	1.4 1.6	>1989 1.7 >1989 2.0	>1989 2.1 D
 <p>← Lungh. Tot. = 713 mm → Cave 23 Cave Int. 27</p>	RIFERIMENTI ORIGINALI		 <p>← Lungh. Tot. = 713 mm → Cave Int. 27 Cave 23</p>
	7701349769 7701351172 7701498955		
LATO SX	RE 00176		RE 00176 LATO DX

NOTE



Trafic	1.4 1.6	89>01 1.7 89>01 2.0	89>01 2.1 89>01 4x4	89>01 89>01
 <p>← Lungh. Tot. = 715 mm → Cave 25 Cave Int. 27</p>	RIFERIMENTI ORIGINALI		 <p>← Lungh. Tot. = 715 mm → Cave Int. 27 Cave 25</p>	
	7701351607 7701465773			
LATO SX	RE 00177		RE 00177 LATO DX	

NOTE

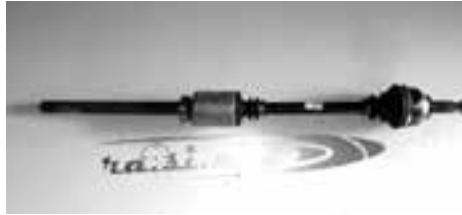
Trafic II		1.9 DCI 60/74Kw 2.0 88Kw	2001> 2001>	
 <p>← Lungh. Tot. = 670 mm → Cave 27 Rullo Ø 37</p>	RIFERIMENTI ORIGINALI		 <p>← Lungh. Tot. = 1018 mm → Cave 39 Cave 27</p>	
	8200334338 8200485589	8200069146 8200169291		
LATO SX	RE 00168		Fusello 363mm	RE 00169 LATO DX
NOTE Fonico Ø 56,4				

Trafic II		2.5 DCI 99Kw	2003>	
 <p>← Lungh. Tot. = 635 mm → Cave 27 Rullo Ø 37</p>	RIFERIMENTI ORIGINALI		 <p>← Lungh. Tot. = 1058 mm → Cave 39 Cave 27</p>	
	4411699 8200169164 8200485590	4411698 8200169163 8200169163 771135440		
LATO SX	RE 01195		Fusello 409mm	RE 01196 LATO DX
NOTE				

Trafic II		2.5 DCI 84Kw 2.5 DCI 107Kw	02/2008> 10/2006>	
 <p>← Lungh. Tot. = 670 mm → Cave 27 Cave 39</p>	RIFERIMENTI ORIGINALI		 <p>← Lungh. Tot. = 1045 mm → Cave 39 Cave 27</p>	
	8200452272 8200776535	8200452273		
LATO SX	RE 01210		Fusello L/C 430mm	RE 01211 LATO DX
NOTE Fonico Ø 56,5 - 27/36				

Trafic II		2.0 DCI 66-84Kw	10/2006>	
 <p>← Lungh. Tot. = 700 mm → Cave 27 Cave 39</p>	RIFERIMENTI ORIGINALI		 <p>← Lungh. Tot. = 1015 mm → Cave 39 Cave 27</p>	
	8200452269	8200452268 93856308		
LATO SX	RE 01212		Fusello 360mm	RE 01213 LATO DX
NOTE				

Twingo

1.2 40/43Kw
1.2 16v 55Kw1993>
01>02← Lungh. Tot. = 623 mm →
Cave 21 Rullo Ø 30LATO SX **RE 00178 - RE 00178/A**

RIFERIMENTI ORIGINALI

7711135243
7701056621

7701351989

A = ABS 38

A = ABS 38

← Lungh. Tot. = 743 mm →
Cave Int. 23 Cave 21**RE 00179 - RE 00179/A** LATO DX**NOTE** ABS 38 su richiesta

Twingo

1.2 16v 43/44/55Kw

2002>

← Lungh. Tot. = 623 mm →
Cave 21 Rullo Ø 30LATO SX **RE 01146**

RIFERIMENTI ORIGINALI

8200240425
82002360927700111077
8200236089← Lungh. Tot. = 745 mm →
Cave Int. 23 Senza Foro Cave 21**RE 00181** LATO DX**NOTE** ABS 44D

Twingo

1.2 55/56Kw

2007>

← Lungh. Tot. = 630 mm →
Cave 23 Rullo Ø 30LATO SX **RE 01200**

RIFERIMENTI ORIGINALI

8200482429

8200684084

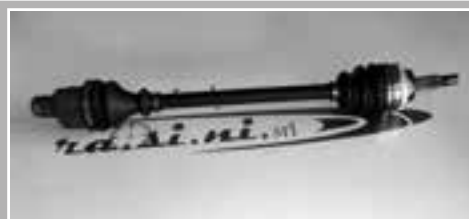
← Lungh. Tot. = 730 mm →
Cave Int. 23 Cave 23**RE 01201** LATO DX**NOTE** Fonico Ø 49

Twingo

1.5 DCI 47/55/62Kw

2007>

← Lungh. Tot. = 615 mm →
Cave 23 Cave 26LATO SX **RE 01202**

RIFERIMENTI ORIGINALI

8200482435
82006615078200482436
8200684084

Fusello L/C 325mm

← Lungh. Tot. = 870 mm →
Cave 26 Cave 23**RE 01203** LATO DX**NOTE** Fonico Ø 49

Twingo		1.5 DCI 55/75Kw 1.5 DCI 63/90Kw	2010> 2010Z	
RIFERIMENTI ORIGINALI				
		8201055632	391007937R 8201055635	
← Lungh. Tot. = 608 mm → Cave 26 Cave 23		Fusello L/C 323mm		← Lungh. Tot. = 862 mm → Cave 23 Cave 26
LATO SX	RE 01228		RE 01229	LATO DX

NOTE

RIFERIMENTI ORIGINALI				
← →				← →
LATO SX				LATO DX

NOTE

RIFERIMENTI ORIGINALI				
← →				← →
LATO SX				LATO DX

NOTE

RIFERIMENTI ORIGINALI				
← →				← →
LATO SX				LATO DX

NOTE

25

2.0 iDT 74Kw

99>05

RIFERIMENTI ORIGINALI

TDB100690

TDB100680E

← Lungh. Tot. = 564 mm →
Cave 26 Cave 29

A = ABS 29D

← Lungh. Tot. = 965 mm →
Cave 29 Cave 26LATO SX **RO 00148 - RO 00148/A****RO 00149 - RO 00149/A** LATO DX

NOTE

25 - 45

1.1 44Kw
1.4 16v 55Kw99>05 | 1.4 16v 62/76Kw
04>05 | 1.6 16v 80Kw

99>05

RIFERIMENTI ORIGINALI

TDB10047

TDB10046

← Lungh. Tot. = 645 mm →
Cave 26 Cave 22

A = ABS 43

A = ABS 43

← Lungh. Tot. = 875 mm →
Cave 22 Cave 26LATO SX **RO 00121 - RO 00121/A****RO 00122 - RO 00122/A** LATO DX

NOTE ABS 43D su richiesta

75 - Tourer

2.0 CDT 85Kw

1999>

RIFERIMENTI ORIGINALI

TDB104950

TDB104940

← Lungh. Tot. = 615 mm →
Cave 28 Cave 34LATO SX **RO 00141**← Lungh. Tot. = 955 mm →
Cave 34 Cave 28**RO 00142** LATO DX

NOTE Fonico Ø 57,7

100

1.1 44Kw
1.41990> | 1.5 D 42Kw
1990>

1990>



RIFERIMENTI ORIGINALI



GCV1071



GCV1070



← Lungh. Tot. = 600 mm →
Cave 25 Cave 22LATO SX **RO 00101**← Lungh. Tot. = 810 mm →
Cave 22 Cave 25**RO 00102** LATO DX



NOTE



200 - 400	1.3	84>89	
	RIFERIMENTI ORIGINALI		
← Lungh. Tot. = 880 mm → Cave 23 Cave 25		ADU7772 GCV1009	← Lungh. Tot. = 578 mm → Cave 25 Cave 23
LATO SX RO 00103			RO 00104 LATO DX
NOTE			

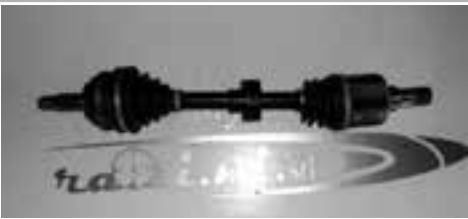

200 - 400	1.1 44Kw 1.4 55/76Kw	98>00 1.6 82Kw 95>00	95>00
	RIFERIMENTI ORIGINALI		
← Lungh. Tot. = 643 mm → Cave 26 Cave 22	TDB10047 A = ABS 43	TDB10046 A = ABS 43	← Lungh. Tot. = 880 mm → Cave 22 Cave 26
LATO SX RO 00105 - RO 00105/A			RO 00106 - RO 00106/A LATO DX
NOTE ABS 43D su richiesta			



200 - 400	1.8 TD 65Kw 1.9 TD 49Kw	91>95 91>95	
	RIFERIMENTI ORIGINALI		
← Lungh. Tot. = 595 mm → Cave 26 Cave 29	A = ABS 27	A = ABS 27	← Lungh. Tot. = 928 mm → Cave 29 Cave 26
LATO SX RO 00107 - RO 00107/A			RO 00108 - RO 00108/A LATO DX
NOTE			



200 - 400	2.0 100Kw 2.0	1991> 2.0 GTI 103Kw 1991> 2.0 Turbo 147Kw	1991> 1991>
	RIFERIMENTI ORIGINALI		
← Lungh. Tot. = 590 mm → Cave 26 Cave 29	A = ABS 43 B = ABS 27	A = ABS 43 B = ABS 27	← Lungh. Tot. = 940 mm → Cave 29 Cave 26
LATO SX RO 00109 - /A - /B			RO 00110 - /A - /B LATO DX
NOTE ABS 27-43D su richiesta			

200 - 400		1.6 16V	1990>	
 <p>← Lungh. Tot. = 605 mm → Cave 26 Cave 27</p>	RIFERIMENTI ORIGINALI		 <p>← Lungh. Tot. = 605 mm → Cave 27 Cave 26</p>	
	<p>443055F0030</p> <p>Fusello L/C tutto incavato A = ABS 50</p>	<p>443065B0010 443065B0971</p> <p>A = ABS 50</p>		<p>RO 00119 - RO 00119/A</p>
LATO SX				LATO DX
NOTE ABS 50D su richiesta				



200 - 400		1.4 SI 76Kw 1.6 SI 82/83Kw	95>00 95>00	
 <p>← Lungh. Tot. = 620 mm → Cave 26 Cave 22</p>	RIFERIMENTI ORIGINALI		 <p>← Lungh. Tot. = 910 mm → Cave 22 Cave 26</p>	
	<p>A = ABS 43</p>	<p>A = ABS 43</p>		<p>RO 00132 - RO 00132/A</p>
LATO SX				LATO DX
NOTE ABS 43D su richiesta				

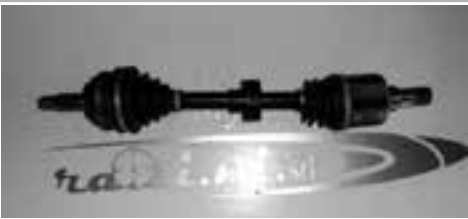

400		420 D 420 DI	95>00 95>00	
 <p>← Lungh. Tot. = 562 mm → Cave 26 Cave 29</p>	RIFERIMENTI ORIGINALI		 <p>← Lungh. Tot. = 965 mm → Cave 29 Cave 26</p>	
	<p>A = ABS 43</p>	<p>A = ABS 43</p>		<p>RO 00134 - RO 00134/A</p>
LATO SX				LATO DX
NOTE ABS 43D su richiesta				

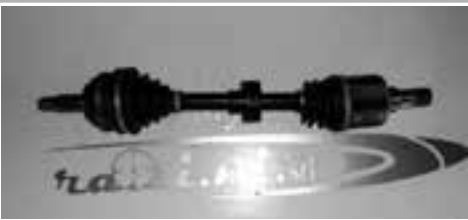
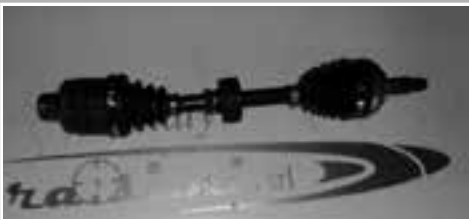
600		2.0 85/96Kw 2.3 116Kw	93>94 93>94	
 <p>← Lungh. Tot. = 605 mm → Cave 28 Cave 27</p>	RIFERIMENTI ORIGINALI		 <p>← Lungh. Tot. = 555 mm → Cave Int. 27 Cave 28</p>	
	<p>A = ABS 50</p>	<p>A = ABS 50</p>		<p>RO 00123 - RO 00123/A</p>
LATO SX				LATO DX
NOTE ABS 50D su richiesta				

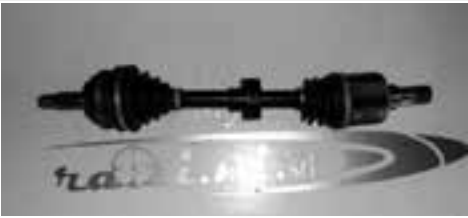
600	2.0 SDI 77Kw	94>99		
	RIFERIMENTI ORIGINALI			
← Lungh. Tot. = 585 mm → Cave 28 Cave 29	A = ABS 50	A = ABS 50	← Lungh. Tot. = 985 mm → Cave 29 Cave 28	
LATO SX RO 00125 - RO 00125/A			RO 00126 - RO 00126/A LATO DX	
NOTE ABS 50D su richiesta				

600	1.8 85Kw 2.0 85/96Kw	96>99 94>99	2.3 116Kw	94>99
	RIFERIMENTI ORIGINALI			
← Lungh. Tot. = 594 mm → Cave 28 Cave 27	A = ABS 50	A = ABS 50	← Lungh. Tot. = 565 mm → Cave Int. 27 Cave 28	
LATO SX RO 00137 - RO 00137/A			RO 00138 - RO 00138/A LATO DX	
NOTE				

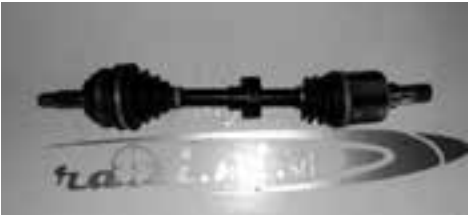
800	2.0 75/103Kw 2.0	86>94 86>94		
	RIFERIMENTI ORIGINALI			
← Lungh. Tot. = 585 mm → Cave 28 Cave 29	A = ABS 45	A = ABS 45	← Lungh. Tot. = 985 mm → Cave 29 Cave 28	
LATO SX RO 00127 - RO 00127/A			RO 00128 - RO 00128/A LATO DX	
NOTE ABS 45D su richiesta				

800	2.5 TD	90>99		
	RIFERIMENTI ORIGINALI			
← Lungh. Tot. = 587 mm → Cave 28 Cave 25	A = ABS 45	A = ABS 45	← Lungh. Tot. = 990 mm → Cave 25 Cave 28	
LATO SX RO 00129 - RO 00129/A			RO 00130 - RO 00130/A LATO DX	
NOTE ABS 45D su richiesta				

800

2.5
2.786>94
86>94

← Lungh. Tot. = 650 mm →
Cave 28 Cave 29

LATO SX **RO 00131 - RO 00131/A**

RIFERIMENTI ORIGINALI

A = ABS 45

A = ABS 45



← Lungh. Tot. = 650 mm →
Cave 29 Cave 28

RO 00131 - RO 00131/A LATO DX**NOTE** ABS 45D su richiesta

Metro

1.0
1.3>1990
>1990

← Lungh. Tot. = 595 mm →
Cave 29 Cave Int. 21

LATO SX **RO 00111**

RIFERIMENTI ORIGINALI



← Lungh. Tot. = 670 mm →
Cave Int. 21 Cave 29

RO 00112 LATO DX**NOTE**

Metro

1.0
1.11990> 1.3
1990> 1.3 Turbo1990> 1.5 D
1990>

1990>

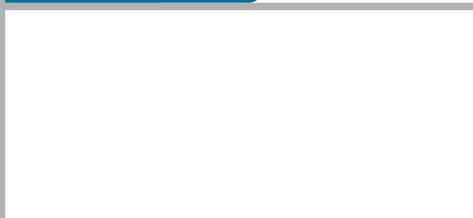

← Lungh. Tot. = 595 mm →
Cave 25 Ø 78

LATO SX **RO 00113**

RIFERIMENTI ORIGINALI

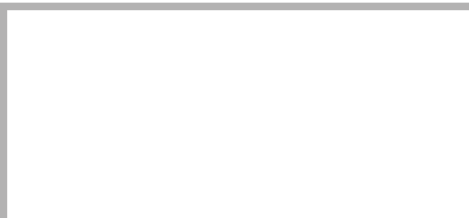

← Lungh. Tot. = 810 mm →
Ø 78 Cave 25

RO 00114 LATO DX**NOTE**

Mini

850 25Kw
1.0 33Kw>1984
>1984

← Lungh. Tot. = 554 mm →
Cave 29 Cave Int. 21



LATO SX **RO 00115**

RIFERIMENTI ORIGINALI



← Lungh. Tot. = 635 mm →
Cave Int. 21 Cave 29

RO 00116 LATO DX**NOTE**

Montego		1.6 61Kw 2.0 74Kw	88>91 86>94	
 <p>← Lungh. Tot. = 550 mm → Cave 25 Cave 29</p>		RIFERIMENTI ORIGINALI		 <p>← Lungh. Tot. = 965 mm → Cave 29 Cave 25</p>
LATO SX		RO 00117		LATO DX
				RO 00118

NOTE

 <p>← →</p>		RIFERIMENTI ORIGINALI		 <p>← →</p>
LATO SX				LATO DX

NOTE

 <p>← →</p>		RIFERIMENTI ORIGINALI		 <p>← →</p>
LATO SX				LATO DX

NOTE

 <p>← →</p>		RIFERIMENTI ORIGINALI		 <p>← →</p>
LATO SX				LATO DX

NOTE

9.3

2.0 I 96/110Kw
2.0 Turbo 136/147 Kw1998> | 2.2 TDI 85/92 Kw
1998> | 2.3 I 110 Kw1998> |
1998> |← Lungh. Tot. = 600 mm →
Cave 33 Cave 34

LATO SX

SA 00107

RIFERIMENTI ORIGINALI

← Lungh. Tot. = 935 mm →
Cave Int. 34 Cave 33

SA 00108

LATO DX

NOTE ABS 29D

9.5

2.0 T
2.0 TDI2001> |
2002> |← Lungh. Tot. = 610 mm →
Cave 30 Cave 27

LATO SX

SA 00109

RIFERIMENTI ORIGINALI

← Lungh. Tot. = →
Cave Int. Cave 30

SA 00110

LATO DX

NOTE ABS 29D su richiesta

9.5

2.0 TDI AUT.

01/2010> |

← Lungh. Tot. = 618 mm →
Cave 30 Cave 27

LATO SX

OP 01014

RIFERIMENTI ORIGINALI

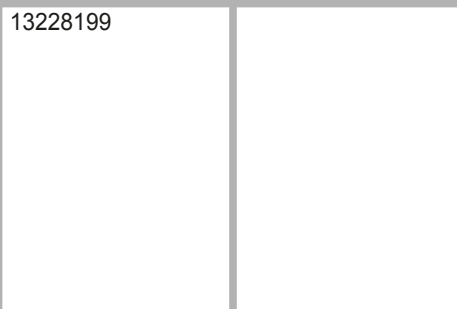
← Lungh. Tot. = 618 mm →
Cave Int. Cave 30

OP 01014

LATO DX

NOTE

900

2.0 98/120Kw
2.0 I 107/108Kw88>93 | 2.0 Turbo
88>93 |

88>93 |

← Lungh. Tot. = 567 mm →
Cave 25 Rullo Ø 37

LATO SX

SA 00101 - SA 00101/A

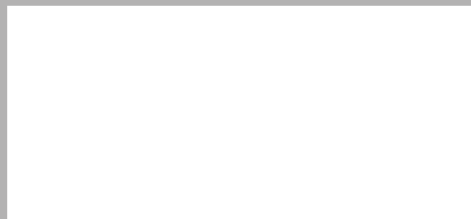
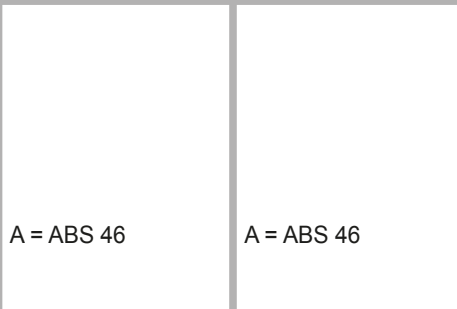

RIFERIMENTI ORIGINALI



← Lungh. Tot. = 620 mm →
Rullo Ø 37 Cave 25

SA 00102 - SA 00102/A

LATO DX



NOTE ABS 46D su richiesta



900	2.0 1993> 2.3	1993>	RIFERIMENTI ORIGINALI		
	← Lungh. Tot. = 582 mm → Cave 33 Cave 34	A = ABS 29	A = ABS 29		← Lungh. Tot. = 540 mm → Cave Int. 34 Cave 33
LATO SX	SA 00103 - SA 00103/A		SA 00104 - SA 00104/A		LATO DX
NOTE ABS 29D su richiesta					



900	2.0 T 2.5 V6	1993> 1993>	RIFERIMENTI ORIGINALI		
	← Lungh. Tot. = 590 mm → Cave 33 Cave 34	A = ABS 29	A = ABS 29		← Lungh. Tot. = 590 mm → Cave Int. 34 Cave 33
LATO SX	SA 00105 - SA 00105/A		SA 00106 - SA 00106/A		LATO DX
NOTE ABS 29D su richiesta					



	RIFERIMENTI ORIGINALI		
← →			← →
LATO SX			LATO DX
NOTE			

	RIFERIMENTI ORIGINALI		
← →			← →
LATO SX			LATO DX
NOTE			

Alhambra	2.0 1.9 TDI	2000> 2000>		
 <p>← Lungh. Tot. = 515 mm → Cave 38 Fori Ø10 Int. fori 104</p>	RIFERIMENTI ORIGINALI		 <p>← Lungh. Tot. = 515 mm → Fori Ø10 Int. fori 104 Cave 38</p>	
		7M3407271P		
LATO SX	FO 00125			LATO DX
NOTE ABS 48D				

Alhambra	1.9 DTI 69/81Kw 2.0 I 85Kw	96>00 2.3 I 107Kw 1995> 2.8 V6	1997> 1995>	
 <p>← Lungh. Tot. = 620 mm → Cave 38 Cave 26</p>	RIFERIMENTI ORIGINALI		 <p>← Lungh. Tot. = 560 mm → Cave Int. 35 Cave 38</p>	
		7M0407271J		7M0407272E
LATO SX	FO 00126			LATO DX
NOTE ABS 48D				

Altea	1.6 75Kw 1.6 Multifuel 75Kw	2004> 1.6 LPG 75Kw 2006>	2009>	
 <p>← Lungh. Tot. = 544 mm → Cave 36 Ø 100</p>	RIFERIMENTI ORIGINALI		 <p>← Lungh. Tot. = 798 mm → Ø 100 Cave 36</p>	
		1K0407271AQ 1K0407271DJ		1K0407272HK 1K0407272JT
LATO SX	AU 00180			LATO DX
NOTE				

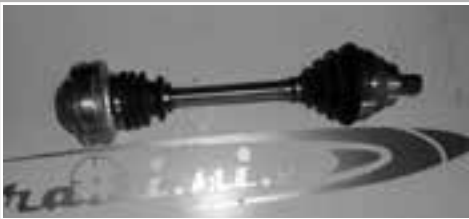

Altea	1.6 TDI 77Kw 1.9 TDI 77 Kw	09/2009> XL 1.9 TDI 77Kw 2004>	2006>	
 <p>← Lungh. Tot. = 521 mm → Cave 36 Ø 100</p>	RIFERIMENTI ORIGINALI		 <p>← Lungh. Tot. = 815 mm → Ø 100 Cave 36</p>	
		1K0407271AT		1K0407272CC 1K0407272GM
LATO SX	AU 00153			LATO DX
NOTE				

Altea		2.0 TDI 100Kw 2.0 TDI 103Kw	04>09 2004>	
		RIFERIMENTI ORIGINALI		
← Lungh. Tot. = 490 mm → Cave 36 Ø 108		1K0407271BJ		← Lungh. Tot. = 490 mm → Ø 108 Cave 36
LATO SX	VW 00162			VW 00162 LATO DX

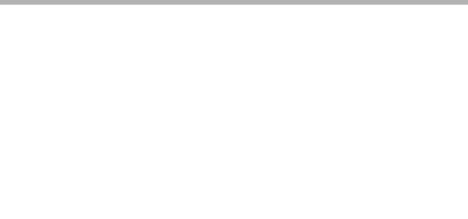
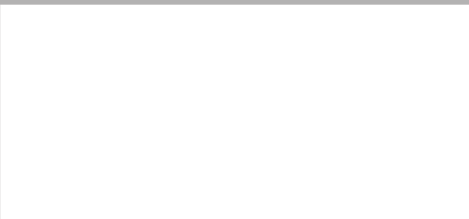

NOTE

Altea		1.2 TSI 16v 77Kw 1.4 16v 92Kw	2010> 2007>	
		RIFERIMENTI ORIGINALI		
← Lungh. Tot. = 530 mm → Cave 36 Ø 100		1K0407271KP 1K0407271HQ 1K0407271KA 1K0407763GX 1K0407761DX 1K0407761MX		← Lungh. Tot. = Ø 100 Cave 36
LATO SX	SE 00138			SE 00139 LATO DX

NOTE

Altea		1.4 16v 63Kw XL 1.4 16v 63Kw	2010> 2010>	
		RIFERIMENTI ORIGINALI		
← Lungh. Tot. = 560 mm → Cave 36 Ø 94				← Lungh. Tot. = 782 mm → Ø 94 Cave 36
LATO SX	VW 01024			VW 01025 LATO DX

NOTE

Altea		XL 2.0 TDI 16v 125Kw	2009>	
		RIFERIMENTI ORIGINALI		
← Lungh. Tot. = 490 mm → Cave 36 Ø 108				← Lungh. Tot. = 795 mm → Ø 108 Cave 36
LATO SX	VW 00162			AU 00161 LATO DX

NOTE

Altea

1.6 C/A 6 Marce
1.6 FSI.C/A.6.Marce

2.0 FSI 75/80/110Kw C/A 2013>

RIFERIMENTI ORIGINALI

1K0407271BD

1K0407272FS
1K0407272KB
1K0407452QX← Lungh. Tot. = 585 mm →
Cave 36 Cave 26← Lungh. Tot. = 880 mm →
Cave 26 Cave 36

LATO SX

VW 00198

VW 00199

LATO DX

NOTE

Arosa

1.0 37Kw
1.4 44Kw1997> 1.4 16v 74Kw
1997> 1.7 SDI 44Kw2000>
1997>

RIFERIMENTI ORIGINALI

6N0407271

6N0407272

← Lungh. Tot. = 515 mm →
Cave 22 Ø 92← Lungh. Tot. = 735 mm →
Ø 92 Cave 22

LATO SX

SE 00121

SE 00122

LATO DX

NOTE

Arosa

1.4 TDI 55Kw

00>04

RIFERIMENTI ORIGINALI

6X0407271K

6X0407272E

← Lungh. Tot. = 525 mm →
Cave 22 Ø 72 stellare← Lungh. Tot. = 715 mm →
Ø 72 stellare Cave 22

LATO SX

VW 00135

VW 00136

LATO DX

NOTE

Cordoba

1.6 I 74Kw
1.9 SDI 47Kw1996> 1.9 D 47/80Kw
1996>

1993>

RIFERIMENTI ORIGINALI

191407271R

191407272A
191407274AX
191407274X← Lungh. Tot. = 540 mm →
Cave 22 Ø 90← Lungh. Tot. = 775 mm →
Ø 90 Cave 22



LATO SX

SE 00111



SE 00112

LATO DX



NOTE

Cordoba	1.4 44Kw 1.6 55Kw	1994> 1994>		
	RIFERIMENTI ORIGINALI			
← Lungh. Tot. = 562 mm Cave 22 Ø 90 →	191407271 191407271NV 191407272N	191407272A 191407272AC 191407272BA	← Lungh. Tot. = 760 mm Ø 90 Cave 22 →	
LATO SX SE 00109			SE 00110	LATO DX



NOTE

Cordoba	1.8 66Kw 1.9 TD 55Kw	1994> 1993>	2.0 85Kw 1.8 16V 95Kw	1993> 1993>
	RIFERIMENTI ORIGINALI			
← Lungh. Tot. = 535 mm Cave 22 Ø 100 →	191407271K 191407271HX 191407271T	191407272H 191407272CV 191407272AF	← Lungh. Tot. = 770 mm Ø 100 Cave 22 →	
LATO SX SE 00113			SE 00114	LATO DX



NOTE

Cordoba	1.4 TDI 55Kw 1.4 TDI 59Kw	02>05 05>09	1.9 TDI 74Kw	02>09
	RIFERIMENTI ORIGINALI			
← Lungh. Tot. = 473 mm Cave 36 Stellare Ø 72 Fori Ø 10 →	6Q0407271DB 6Q0407271BS 6Q0407451FX	6Q0407272BK 6Q0407452HX	← Lungh. Tot. = 762 mm Stellare Ø 72 Fori Ø 10 Cave 36 →	
LATO SX VW 00160			VW 00161	LATO DX

NOTE

Ibiza - Inca	1.9 D-SDI 47Kw Inca 1.6 52/55Kw	1993> 1995>	Inca 1.9 D 47Kw	1995>
	RIFERIMENTI ORIGINALI			
← Lungh. Tot. = 540 mm Cave 22 Ø 94 →	191407271B	191407274RX	← Lungh. Tot. = 775 mm Ø 94 Cave 22 →	
LATO SX SE 00101			SE 00102	LATO DX



NOTE

Ibiza - Inca		1.0 33Kw 1.3 40Kw	1993> 1.4 44Kw 1993> 1.6 55Kw	1993> Inca 1.4 44Kw 1993>	1995>
		RIFERIMENTI ORIGINALI			
← Lungh. Tot. = 562 mm → Cave 22 Ø 94		191407271 1H0407449BX	6K0407452DX 6K0407452GX	← Lungh. Tot. = 760 mm → Ø 94 Cave 22	
LATO SX SE 00105				SE 00106 LATO DX	

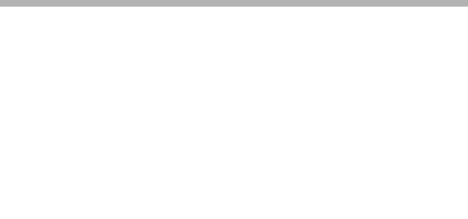
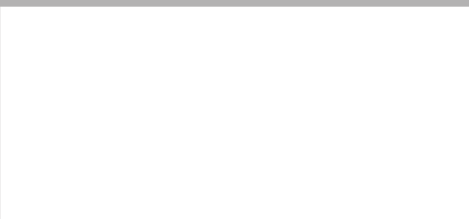

NOTE

Ibiza		RIFERIMENTI ORIGINALI			
		6C0407271H	6C0407272H		
← Lungh. Tot. = mm → Cave 36 Cave 26				← Lungh. Tot. = 805 mm → Cave 26 Cave 36	
LATO SX VW 01004				VW 01005 LATO DX	



NOTE



Ibiza		1.8 66Kw 1.9 TD 55Kw	1994> 2.0 85Kw 1993> 1.8 16V 95Kw	1993> 1993>	
		RIFERIMENTI ORIGINALI			
← Lungh. Tot. = 535 mm → Cave 22 Ø 100		191407271K 191407271HX 191407271T	191407272H 191407272CV 191407272AF	← Lungh. Tot. = 770 mm → Ø 100 Cave 22	
LATO SX SE 00113				SE 00114 LATO DX	



NOTE



Ibiza		1.4 55/74Kw	99>02		
		RIFERIMENTI ORIGINALI			
← Lungh. Tot. = 562 mm → Cave 22 Ø 94		191407271 1H0407449BX	6K0407452DX 6K0407452GX	← Lungh. Tot. = 760 mm → Ø 94 Cave 22	
LATO SX SE 00105				SE 00106 LATO DX	



NOTE



Ibiza	1.4 TDI 55/59/74Kw 1.8 T 110Kw	2002> 1.8 T 132Kw 03>08 1.9 TDI 74Kw	04>08 02>09
	RIFERIMENTI ORIGINALI		
← Lungh. Tot. = 473 mm → Cave 36 Stellare Ø72 Fori Ø10	6Q0407271BE 6Q0407271DB 6Q0407451FX	6Q0407272BK 6Q0407452HX	← Lungh. Tot. = 762 mm → Stellare Ø72 Fori Ø10 Cave 36
← Fil. 16x1,5 →	← Fil. 16x1,5 →		
LATO SX VW 00160			VW 00161 LATO DX
NOTE Fonico Ø 52			

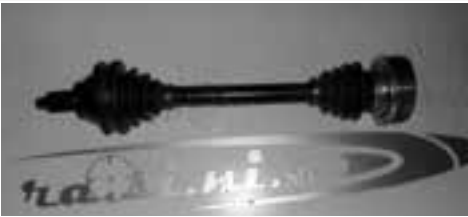

Ibiza	1.2 40Kw 1.4 16v 55/74Kw	2002> 1.9 SDI 47Kw 2002>	2002>
	RIFERIMENTI ORIGINALI		
← Lungh. Tot. = 503 mm → Cave 36 Ø 94	6Q0407271AS 6Q0407451DX 6Q0407451EX	6Q0407272BC 6Q0407272BD 6Q0407452FX 6Q0407452GX	← Lungh. Tot. = 753 mm → Ø 94 Cave 36
LATO SX VW 00164			VW 00165 LATO DX
NOTE			

Ibiza	Ibiza 1.9 TDI 96 Kw Ibiza 1.9 TDI 118Kw	2002> 2004>	
	RIFERIMENTI ORIGINALI		
← Lungh. Tot. = 465 mm → Cave 36 Ø 108 H 33	6Q0407271J	6Q0407272J	← Lungh. Tot. = 775 mm → Ø 108 H 33 Cave 36
LATO SX SE 00107			SE 00108 LATO DX
NOTE			



Ibiza	Ibiza 1.4 TDI 59Kw	2008>	
	RIFERIMENTI ORIGINALI		
← Lungh. Tot. = 525 mm → Cave 36 Stellare 72 Fori Ø 10	← Fil. 16x1,5 →	← Fil. 16x1,5 →	← Lungh. Tot. = 724 mm → Stellare 72 Fori Ø 10 Cave 36
LATO SX SE 00132			SE 00133 LATO DX
NOTE			

Ibiza		1.2 55Kw 1.6 TDI 66Kw	2006> 1.6 TDI 77Kw 2009>	2010>
		RIFERIMENTI ORIGINALI		
← Lungh. Tot. = 490 mm → Cave 36 Ø 100		6R0407761AX	6R0407762AX	← Lungh. Tot. = 785 mm → Ø 100 Cave 36
LATO SX VW 01013				VW 01014 LATO DX
NOTE				

Ibiza		1.4 TDI 59Kw 1.9 TDI 66/77Kw	08>10 08>10	
		RIFERIMENTI ORIGINALI		
← Lungh. Tot. = 486 mm → Cave 36 Stellare Ø 72		6R0407761L	6R0407762E	← Lungh. Tot. = 770 mm → Stellare Ø 72 Cave 36
LATO SX SE 00134				SE 00135 LATO DX
NOTE				

Ibiza		V12 TFSI 77Kw	2010>	
		RIFERIMENTI ORIGINALI		
← Lungh. Tot. = 530 mm → Cave 36 Stellare Ø 100		1K0407271KP 1K0407271HQ 1K0407271KA 1K0407763GX 1K0407761DX 1K0407761MX	1K0407272NN 1K0407272QM 1K0407272MP	← Lungh. Tot. = Ø 100 Cave 36
LATO SX SE 00138				SE 00138 LATO DX
NOTE				

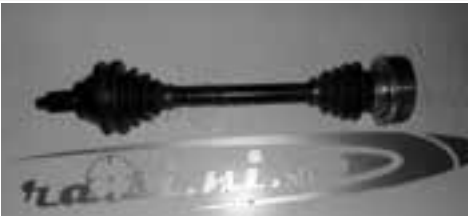

Ibiza IV		1.6 16v 77Kw C/A	06>09	
		RIFERIMENTI ORIGINALI		
← Lungh. Tot. = mm570 → Cave 36 Cave 26		6Q0407271EE		← Lungh. Tot. = mm → Cave Cave
LATO SX VW 00170				VW 00171 LATO DX
NOTE				

Ibiza V	1.4 TSI 103Kw 2.0 TDI 105Kw	2010> 2010>			
 <p>← Cave 36 → Ø 108</p>	RIFERIMENTI ORIGINALI		 <p>← Ø 108 → Cave 36</p>		
	6R0407761F	6R0407762F			
LATO SX	AU 00191			AU 00192	LATO DX

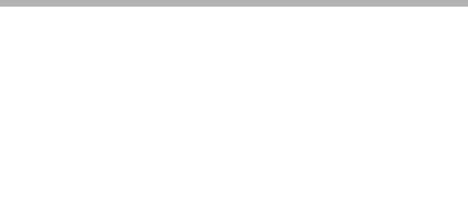
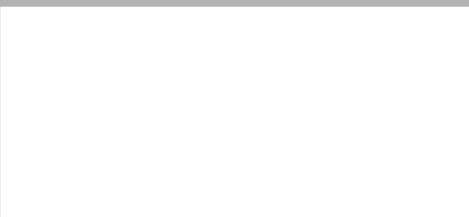

NOTE

Leon	1.6 C/A 6 Marce 1.6 FSI.C/A.6.Marce	2.0 FSI 75/80/110Kw C/A	2013>		
 <p>← Lungh. Tot. = 585 mm → Cave 36 Cave 26</p>	RIFERIMENTI ORIGINALI		 <p>← Lungh. Tot. = 880 mm → Cave 26 Cave 36</p>		
	1K0407271BD	1K0407272FS 1K0407272KB 1K0407452QX			
LATO SX	VW 00198			VW 00199	LATO DX



NOTE

Leon	1.4 16v 55Kw 1.6 74Kw	1999> 1999>			
 <p>← Lungh. Tot. = 555 mm → Cave 36 Ø 90</p>	RIFERIMENTI ORIGINALI		 <p>← Lungh. Tot. = 822 mm → Ø 90 Cave 36</p>		
	1J0407271AH 1J0407271AM 1J0407271Q	1J0407272BL			
LATO SX	VW 00117			VW 00118	LATO DX

NOTE

Leon	1.8 20v 92Kw 1.9 TDI 81 Kw	1999> 1999>	1.9 TDI 66 Kw	1999>	
 <p>← Lungh. Tot. = 556 mm → Cave 36 Ø 100</p>	RIFERIMENTI ORIGINALI		 <p>← Lungh. Tot. = 825 mm → Ø 100 Cave 36</p>		
	1J0407271JL	1J0407272 1J0407272AT			
LATO SX	VW 00119			VW 00120	LATO DX



NOTE

Leon	1.9 TDI 77Kw 2.0 FSI 110Kw	2005> 2005>	2.0 TDI 100/103Kw	2005>
	RIFERIMENTI ORIGINALI			
	1K0407271CP 1K0407451FX 1K0407271AT		1K0407272CC	
← Lungh. Tot. = 521 mm → Cave 36 Ø 100			← Lungh. Tot. = 815 mm → Ø 100 Cave 36	
LATO SX AU 00153			AU 00154 LATO DX	

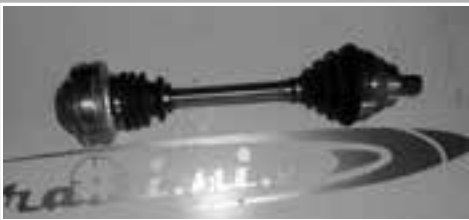

NOTE Fonico Ø 59,5

Leon	2.0 TDI 103Kw	2005>		
	RIFERIMENTI ORIGINALI			
	1K0407271BJ			
← Lungh. Tot. = 490 mm → Cave 36 Ø 108			← Lungh. Tot. = 490 mm → Ø 108 Cave 36	
LATO SX VW 00162			VW 00162 LATO DX	

NOTE

Leon	1.4 16v 63Kw	2006>		
	RIFERIMENTI ORIGINALI			
← Lungh. Tot. = 560 mm → Cave 36 Cave 94			← Lungh. Tot. = 782 mm → Cave 94 Cave 36	
LATO SX VW 01024			VW 01025 LATO DX	

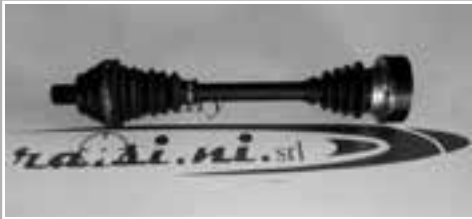

NOTE

Leon	1.6 75Kw 1.6 LPG 75Kw	2005> 2009>	1.6 Multifuel 75Kw	2010>
	RIFERIMENTI ORIGINALI			
← Lungh. Tot. = 544 mm → Cave 36 Cave 100			← Lungh. Tot. = 798 mm → Cave 100 Cave 36	
LATO SX AU 00180			AU 00181 LATO DX	

NOTE

Leon	1.2 TFSI 77Kw 1.4 TSI 92Kw	10>12 07>12		
RIFERIMENTI ORIGINALI				
		1K0407271KP 1K0407271HQ 1K0407271KA 1K0407763GX 1K0407761DX 1K0407761MX	1K0407272NN 1K0407272QM 1K0407272MP	
← Lungh. Tot. = 530 mm → Cave 36 Cave 100				← →
LATO SX	SE 00138		SE 00139	LATO DX
NOTE				

Leon	1.8 T 165Kw	03>06			
RIFERIMENTI ORIGINALI					
					
← Lungh. Tot. = 490 mm → Cave 36 Ø 108				← Lungh. Tot. = 803 mm → Ø 108 Cave 36	
LATO SX	VW 00162		VW 00174	LATO DX	
NOTE					

Leon	2.0 TDI 16v 103/105Kw	2010>			
RIFERIMENTI ORIGINALI					
					
← Lungh. Tot. = 490 mm → Cave 36 Ø 108				← Lungh. Tot. = 762 mm → Stellare Ø72 Fori Ø10 Cave 36	
LATO SX	VW 00162		AU 00161	LATO DX	
NOTE					

Toledo	1.6 C/A 6 Marce 1.6 FSI.C/A.6.Marce	2.0 FSI 75/80/110Kw C/A	2013>	
RIFERIMENTI ORIGINALI				
		1K0407271BD	1K0407272FS 1K0407272KB 1K0407452QX	
← Lungh. Tot. = 585 mm → Cave 36 Cave 26				← Lungh. Tot. = 880 mm → Cave 26 Cave 36
LATO SX	VW 00198		VW 00199	LATO DX
NOTE				

Toledo

1.9 TDI 77Kw

04>09



← Lungh. Tot. = 521 mm →
Cave 36 Ø 100

LATO SX

AU 00153

RIFERIMENTI ORIGINALI

1K0407271CP
1K0407451FX
1K0407271AT

1K0407272CC



← Lungh. Tot. = 815 mm →
Ø 100 Cave 36

AU 00154

LATO DX

NOTE

Toledo

2.0 TDI 103Kw

04>09

Fino al telaio n. 5P-5-047000



← Lungh. Tot. = 490 mm →
Cave 36 Ø 108

LATO SX

VW 00162

RIFERIMENTI ORIGINALI

1K0407271BJ



← Lungh. Tot. = 490 mm →
Ø 108 Cave 36

VW 00162

LATO DX

NOTE

Toledo

2.0 TDI 103Kw

2004>

Dal telaio n. 5P-5-047001



← Lungh. Tot. = 490 mm →
Cave 36 Ø 108

LATO SX

VW 00162

RIFERIMENTI ORIGINALI

1K0407271BJ

1K0407272EN
1K0407272NJ
1K0407762PX



← Lungh. Tot. = 798 mm →
Ø 108 Cave 36

AU 00161

LATO DX

NOTE

Toledo

1.6 75Kw

10/04>05/09



← Lungh. Tot. = 544 mm →
Cave 36 Cave 100

LATO SX

AU 00180

RIFERIMENTI ORIGINALI





← Lungh. Tot. = 798 mm →
Cave 100 Cave 36

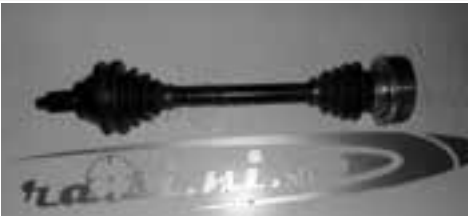

AU 00181

LATO DX



NOTE

Fabia	1.4 16v 55/74Kw 1.9 SDI 47Kw	1999> 1999>		
	RIFERIMENTI ORIGINALI			
← Lungh. Tot. = 500 mm Cave 36 Fil.16x1,5 → Ø 94	6Q0407271AS 6Q0407271AT 6Q0407451DX 6Q0407451EX	6Q0407272BC 6Q0407272BD 6Q0407452EX 6Q0407452FX	← Lungh. Tot. = 750 mm Ø 94 → Cave 36 Fil.16x1,5	
LATO SX	SK 00103		SK 00104	LATO DX



NOTE

Fabia	1.0 37Kw 1.2 40Kw	99>02 01>08	1.4 44Kw	00>07
	RIFERIMENTI ORIGINALI			
← Lungh. Tot. = 488 mm Cave 36 → Ø 94	6Q0407271BC	6Q0407272S	← Lungh. Tot. = 760 mm Ø 94 → Cave 36	
LATO SX	SK 00108		SK 00109	LATO DX



NOTE

Fabia	1.4 TDI 55Kw 1.9 TDI 74Kw	03>08 00>08		
	RIFERIMENTI ORIGINALI			
← Lungh. Tot. = 477 mm Cave 36 Stellare 72 Fori Ø 10 → Fil.16x1,5	6Q0407271BS 6Q0407271DB 6Q0407451FX	6Q0407272BK 6Q0407452HX	← Lungh. Tot. = 762 mm Stellare 72 Fori Ø 10 → Cave 36	
LATO SX	SK 00106		SK 00107	LATO DX



NOTE

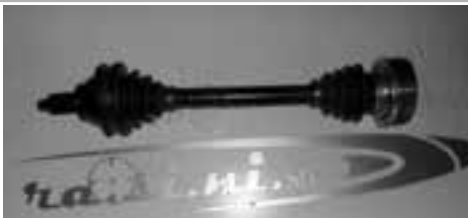

Fabia	1.9 TDI RS 96Kw	2003>		
	RIFERIMENTI ORIGINALI			
← Lungh. Tot. = 465 mm Cave 36 → Ø 108 H 33	6Q0407271J	6Q0407272J	← Lungh. Tot. = 775 mm Ø 108 H 33 → Cave 36	
LATO SX	SE 00107		SE 00108	LATO DX

NOTE

Fabia	1.4 TDI 66Kw	2014		
	RIFERIMENTI ORIGINALI			
← Cave 36 →		6C0407272G	← Lungh. Tot. = 730 mm →	
LATO SX	AU 01002		AU 01003	LATO DX
NOTE				

Fabia	1.2 40/47Kw	02>08		
	RIFERIMENTI ORIGINALI			
← Lungh. Tot. = mm →	6Q0407451DX 6Q0407271AS	6Q0407272DX 6Q0407452NX 6Q0407452EX	← Lungh. Tot. = mm →	
LATO SX	VW 01030		VW 01031	LATO DX
NOTE				

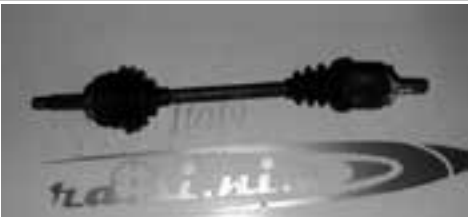
Fabia Combi	1.2 54/64Kw 1.9 SDI 64Kw	01<07 01>07		
	RIFERIMENTI ORIGINALI			
← Lungh. Tot. = 501 mm →	6Q0407271AS	6Q0407272DS	← Lungh. Tot. = 755 mm →	
LATO SX	SK 00112		SK 00113	LATO DX
NOTE				

Favorit - Felicia	1.3 40/45/50Kw 1.3 Pick Up 44Kw	1991> 1989>	1.3 L-LS 42Kw 1.6 55Kw	1998> 1998>	1.9 D 47Kw 1998>
	RIFERIMENTI ORIGINALI				
← Lungh. Tot. = 600 mm →	6U0407271A 115420214	6U0407272A 115420217	← Lungh. Tot. = 870 mm →		
LATO SX	SK 00101		SK 00102	LATO DX	
NOTE					

Octavia	1.6 C/A 6 Marce 1.6 FSI.C/A.6.Marce	2.0 FSI 75/80/110Kw C/A	2013>
RIFERIMENTI ORIGINALI			
1K0407271BD		1K0407272FS 1K0407272KB 1K0407452QX	
← Lungh. Tot. = 585 mm → Cave 36 Cave 26		← Lungh. Tot. = 880 mm → Cave 26 Cave 36	
LATO SX	VW 00198	VW 00199	LATO DX

NOTE

Octavia	1.6 55Kw 1.9 SDI 50Kw	96>00 1997>	
RIFERIMENTI ORIGINALI			
1J0407271AH 1J0407271AM 1J0407271Q		1J0407272BL	
← Lungh. Tot. = 554 mm → Cave 36 Ø 92		← Lungh. Tot. = 822 mm → Ø 92 Cave 36	
LATO SX	VW 00117	VW 00118	LATO DX



NOTE

Octavia	1.9 TDI 81Kw 1.9 TDI 66Kw	1997> 1996>	
RIFERIMENTI ORIGINALI			
1J0407271JL		1J0407272 1J0407272AT	
← Lungh. Tot. = 556 mm → Cave 36 Ø 100		← Lungh. Tot. = 825 mm → Ø 100 Cave 36	
LATO SX	VW 00119	VW 00120	LATO DX



NOTE

Octavia	1.8 T 110Kw	1998>	
RIFERIMENTI ORIGINALI			
		1J0407272CT	
← Lungh. Tot. = 545 mm → Cave 36 Stellare Ø 72 Fori Ø 8		← Lungh. Tot. = 810 mm → Stellare Ø 72 Fori Ø 8 Cave 36	
LATO SX	VW 00146	VW 00147	LATO DX

NOTE

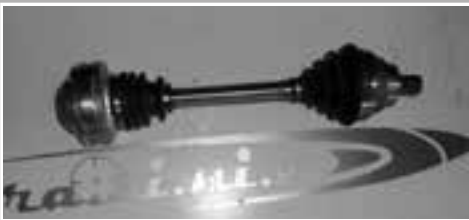
Octavia 1.9 TDI 77Kw 2004>			
 <p>← Lungh. Tot. = 521 mm → Cave 36 Ø 100</p>	RIFERIMENTI ORIGINALI		 <p>← Lungh. Tot. = 815 mm → Ø 100 Cave 36</p>
	1K0407271CP 1K0407451FX 1K0407271AT	1K0407272CC	
LATO SX AU 00153			AU 00154 LATO DX
NOTE			

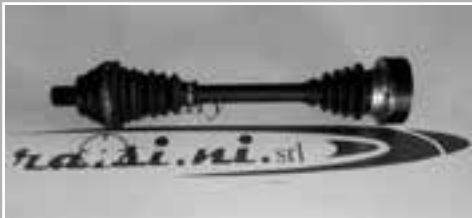
Octavia 2.0 TDI 103Kw 2.0 TDI 16v 100Kw 2005> 04>10			
 <p>← Lungh. Tot. = 490 mm → Cave 36 Ø 108</p>	RIFERIMENTI ORIGINALI		 <p>← Lungh. Tot. = 798 mm → Ø 108 Cave 36</p>
	1K0407271BJ	1K0407272EN 1K0407272NJ 1K0407762PX	
LATO SX VW 00162			AU 00161 LATO DX
NOTE			

Octavia 1.6 75Kw 1.6 LPG 75Kw 2004> 2009>			
 <p>← Lungh. Tot. = 544 mm → Cave 36 Cave 100</p>	RIFERIMENTI ORIGINALI		 <p>← Lungh. Tot. = 798 mm → Ø 100 Cave 36</p>
LATO SX AU 00180			AU 00181 LATO DX
NOTE			

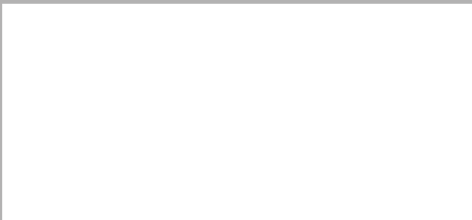
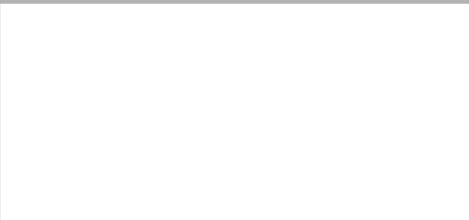
Octavia 1.4 TSI 90Kw 2008>			
 <p>← Lungh. Tot. = 544 mm → Cave 36 Cave 100</p>	RIFERIMENTI ORIGINALI		 <p>← Lungh. Tot. = 798 mm → Ø 100 Cave 36</p>
LATO SX SE 00138			SE 00139 LATO DX
NOTE			

Octavia 1.4 55Kw 1.4 59Kw		04>06 2004>	
	RIFERIMENTI ORIGINALI		
← Lungh. Tot. = 560 mm → Cave 36 Cave 94			← Lungh. Tot. = 782 mm → Cave 94 Cave 36
LATO SX VW 01024			VW 01025 LATO DX
NOTE			

Octavia 1.6 TSI 85Kw04>08 Combi 1.6 TSI 85Kw		04>08	
	RIFERIMENTI ORIGINALI		
← Lungh. Tot. = 560 mm → Cave 36 Ø 100			← Lungh. Tot. = 787 mm → Ø 100 Cave 36
LATO SX VW 00194			VW 00195 LATO DX
NOTE			

Octavia 2.0 TDi 110Kw		2012>	
	RIFERIMENTI ORIGINALI		
← →	5Q0407761X	5Q0407272BT 5Q0407762AX	← →
LATO SX SK 00110			SK 00111 LATO DX
NOTE			

Superb 2.0 TDI 103Kw		2008>	
	RIFERIMENTI ORIGINALI		
← Lungh. Tot. = 490 mm → Cave 36 Ø 108			← Lungh. Tot. = 798 mm → Ø 108 Cave 36
LATO SX VW 00162			AU 00161 LATO DX
NOTE			

Superb

1.9 TDI 77Kw

05>07



← Lungh. Tot. = 600 mm →
Cave 33 Ø130 Stellare

LATO SX

VW 00156

RIFERIMENTI ORIGINALI

8D0407271BQ
8D0407271EK
8D0407451NX

8D0407272BQ
8D0407272EK
8D0407452KX
8D0407452MX



← Lungh. Tot. = 620 mm →
Ø130 Stellare Cave 33

VW 00157

LATO DX

NOTE ABS 45D

Superb

1.9 TDI 74Kw
1.9 TDI 77Kw02>05
05>07

← Lungh. Tot. = 595 mm →
Cave 33 Ø 130 Stellare

LATO SX

VW 00125

RIFERIMENTI ORIGINALI

8D0407271BQ
8D0407271EK
8D0407451NX

8D0407272BQ
8D0407272EK
8D0407452KX
8D0407452MX



← Lungh. Tot. = 615 mm →
Ø 130 Stellare Cave 33

VW 00126

LATO DX

NOTE ABS 45D

Superb

1.8 T 110Kw

02>08



← Lungh. Tot. = 545 mm →
Cave 36 Stellare Ø 72 Fori Ø 8

LATO SX

VW 00146

RIFERIMENTI ORIGINALI

1J0407272CT



← Lungh. Tot. = 810 mm →
Stellare Ø 72 Fori Ø 8 Cave 36

VW 00147

LATO DX

NOTE

Superb

1.9 TDI 96Kw
2.5 TDI 114Kw02>08
02>03

2.5 TDI 120Kw

03>08



← Lungh. Tot. = 602 mm →
Cave 38 Ø 130 Stellare

LATO SX

VW 00127

RIFERIMENTI ORIGINALI

8D0407271AJ
8D0407451CV
8D0407451CX

8D0407272AJ
8D0407452CV
8D0407452CX



← Lungh. Tot. = 621 mm →
Ø 130 Stellare Cave 38



VW 00128

LATO DX

NOTE ABS 45D

Superb		1.8 TSI 118Kw 1.8 TSI 4x4 118Kw	2008> 2008>	
RIFERIMENTI ORIGINALI				
		1K0407271JC 1K0407762TX	1K0407272PC 1K0407272TX	
← Lungh. Tot. = 490 mm → Cave 36 Cave Int. 40				← Lungh. Tot. = 820 mm → Cave Int. 40 Cave 36
LATO SX	VW 01040			VW 01041 LATO DX

NOTE

Yeti		1.6 TDI 77Kw 2.0 TDI 81Kw	05/2009> 05/2009>	
RIFERIMENTI ORIGINALI				
		1K0407271CP 1K0407451FX 1K0407271AT	1K0407272CC	
← Lungh. Tot. = 521 mm → Cave 36 Ø 100				← Lungh. Tot. = 815 mm → Ø 100 Cave 36
LATO SX	AU 00153			AU 00154 LATO DX

NOTE

Yeti		1.2 TSI 77Kw 1.4 TSI 90Kw	2009> 2010>	
RIFERIMENTI ORIGINALI				
		1K0407271KP 1K0407271HQ 1K0407271KA 1K0407763GX 1K0407761DX 1K0407761MX	1K0407272NN 1K0407272QM 1K0407272MP	
← Lungh. Tot. = 530 mm → Cave 36 Cave 100				← Lungh. Tot. = → Ø 100 Cave 36
LATO SX	SE 00138			SE 00139 LATO DX

NOTE

RIFERIMENTI ORIGINALI				
← →				← →
LATO SX				LATO DX

NOTE

Forester		2.0 92Kw 2.0 X 116Kw	02>13 2.0 Turbo 130Kw 05>13 2.5 155Kw	02>13 2.5 169Kw 03>13	03>13
RIFERIMENTI ORIGINALI					
		28321SA033			
← Lungh. Tot. = 781 mm → Cave 27 Cave 25				← Lungh. Tot. = 781 mm → Cave 27 Cave 25	
LATO SX	SU 00103			SU 00103	LATO DX
NOTE ABS 44					

Forester		2.0 TD 108Kw C. Aut.	08>13		
RIFERIMENTI ORIGINALI					
		28321SC020			
← →				← →	
LATO SX	SU 00104			SU 00104	LATO DX
NOTE					

Justy		1.0 4x4 37/41Kw 1.2 4x4 55Kw	90>95 90>95		
RIFERIMENTI ORIGINALI					
← Lungh. Tot. = 578 mm → Cave 27 Cave Int. 22				← Lungh. Tot. = 578 mm → Cave Int. 22 Cave 27	
LATO SX	SU 00101			SU 00101	LATO DX
NOTE					

Justy		1.0 12v 51Kw	2007>		
RIFERIMENTI ORIGINALI					
		43420B1010	43410B1050		
← Lungh. Tot. = 650 mm → Cave 24 Cave 23				← Lungh. Tot. = 870 mm → Cave 23 Cave 24	
LATO SX	SU 00105			SU 00106	LATO DX
NOTE					

Legacy	1.8 4x4 76Kw 1.8 76Kw	1989> 2.0 4x4 85Kw 1989> 2.2 4x4 94Kw	1989> 1989>
RIFERIMENTI ORIGINALI			
← Lungh. Tot. = 685 mm → Cave 27 Cave Int. 25			← Lungh. Tot. = 685 mm → Cave Int. 25 Cave 27
LATO SX	SU 00102		SU 00102 LATO DX

NOTE

RIFERIMENTI ORIGINALI			
← →			← →
LATO SX			LATO DX

NOTE

RIFERIMENTI ORIGINALI			
← →			← →
LATO SX			LATO DX

NOTE

RIFERIMENTI ORIGINALI			
← →			← →
LATO SX			LATO DX

NOTE

Alto

800 FX-GX 27/29kW

>1993



← Lungh. Tot. = 540 mm →
Cave 23 Cave Int. 22

LATO SX

SZ 00103

RIFERIMENTI ORIGINALI

4410278010
4410278011
4410278012

4410178010
4410178011
4410178012



← Lungh. Tot. = 690 mm →
Cave Int. 22 Cave 23

SZ 00104

LATO DX

NOTE

Alto

800 35Kw

95>00



← Lungh. Tot. = 540 mm →
Cave 23 Cave Int. 22

LATO SX

SZ 00105

RIFERIMENTI ORIGINALI



← Lungh. Tot. = 702 mm →
Cave Int. 22 Cave 23

SZ 00106

LATO DX

NOTE

Alto

1.0 43kW
1.0 39kW2000>
94>02

← Lungh. Tot. = 595 mm →
Cave 23 Cave 22

LATO SX

SZ 00123

RIFERIMENTI ORIGINALI

44102M72F12

44101M72F12



← Lungh. Tot. = 828 mm →
Cave 22 Cave 23

SZ 00124

LATO DX

NOTE

Alto

1.0 12v 50Kw

2009>

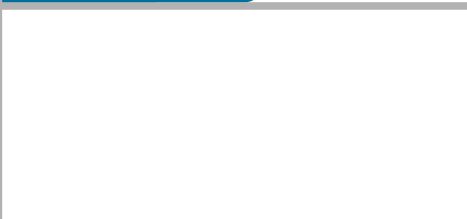

← →

LATO SX

SZ 00146

RIFERIMENTI ORIGINALI

44102M68K50

44101M68K50

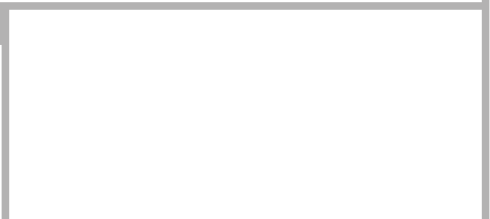





← →



SZ 00147

LATO DX



NOTE

Baleno	1.3 52Kw 1.6 72Kw	96>02 95>02		
	RIFERIMENTI ORIGINALI			
← Lungh. Tot. = 630 mm → Cave 25 Cave 22	A = ABS 42		← Lungh. Tot. = 615 mm → Cave Int. 22 Cave 25	
LATO SX SZ 00119 - SZ 00119/A			SZ 00120 - SZ 00120/A	LATO DX
NOTE ABS 42				

Baleno	1.6 72Kw 1.6 16v 72Kw	95>02 95>02	1.6 SW 72Kw 1.8 GTX 89Kw	95>02 95>02
	RIFERIMENTI ORIGINALI			
← Lungh. Tot. = 610 mm → Cave 25 Cave 22			← Lungh. Tot. = 884 mm → Cave 22 Cave 25	
LATO SX SZ 00148			SZ 00149	LATO DX
NOTE				

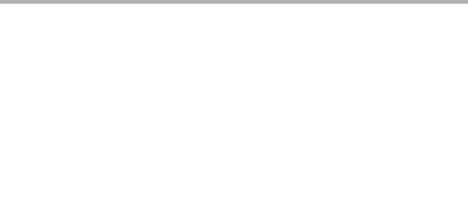
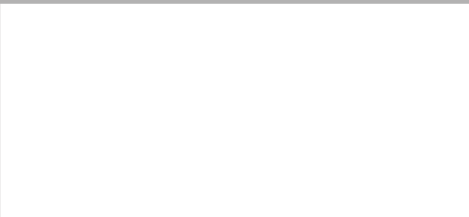
Baleno	1.9 TD 55Kw	1999>		
	RIFERIMENTI ORIGINALI			
← Lungh. Tot. = 580 mm → Cave 25 Cave 22	2780065G10000 2780065G00000		← Lungh. Tot. = 570 mm → Cave Int. 22 Cave 25	
LATO SX SZ 00154			SZ 00155	LATO DX
NOTE				

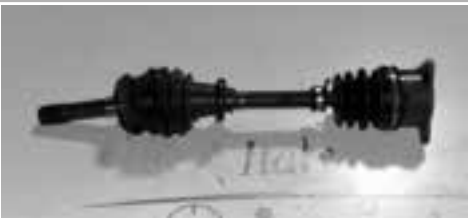
Baleno	1.3 16v 1.3	95>02 96>02	1.6 16v	96>99
	RIFERIMENTI ORIGINALI			
← Lungh. Tot. = 630 mm → Cave 25 Cave 22	4410260G23000 4410160G23000		← Lungh. Tot. = 615 mm → Cave Int. 22 Cave 25	
LATO SX SZ 00152			SZ 00153	LATO DX
NOTE ABS 42				

Gran Vitara	1.6 69Kw 2.0 94Kw	98>03 2.5 106Kw 98>03 2.7 127/135Kw	98>03 2.0 TD 64Kw 98>03	98>03
	RIFERIMENTI ORIGINALI			
← Lungh. Tot. = 536 mm → Cave 26 Ø 105 3 Fori			← Lungh. Tot. = 610 mm → Cave 26 Cave 26	
LATO SX SZ 00117			SZ 00118 LATO DX	



NOTE

Grand Vitara	1.9 Diesel	2006>		
	RIFERIMENTI ORIGINALI			
← Lungh. Tot. = 620 mm → Cave 28 Cave 26	4410265J00	4410265J00	← Lungh. Tot. = 565 mm → Cave 28	
LATO SX SZ 00140	Paraolio Ø 35		SZ 00141 LATO DX	

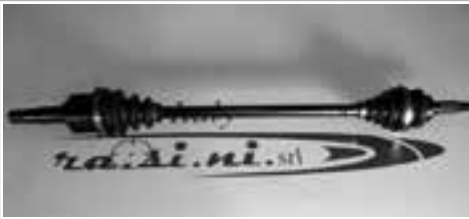

NOTE

Ignis	1.3 61Kw	00>03		
	RIFERIMENTI ORIGINALI			
← Lungh. Tot. = 610 mm → Cave 23 Cave 22		4410180G00	← Lungh. Tot. = 850 mm → Cave Int. 22 Cave 23	
LATO SX SZ 00115			SZ 00116 LATO DX	

NOTE ABS 43D

Ignis	1.3 69Kw 1.3 DDIS 51Kw	2003> 1.5 4x4 73Kw 2003>	2003>	
	RIFERIMENTI ORIGINALI			
← Lungh. Tot. = 635 mm → Cave 25 Cave 22	4410286G00		← Lungh. Tot. = 630 mm → Cave Int. 22 Cave 25	
LATO SX SZ 01123			SZ 01124 LATO DX	

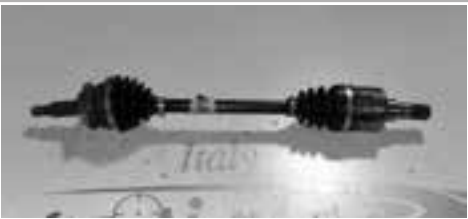
NOTE ABS 43D

Ignis 1.3 DDIS 51Kw 2003>		RIFERIMENTI ORIGINALI	
		44101-86G60 44101-86G61 44101-86G62	
←	→		← Lung. Tot. = 600 mm → Cave 22 Cave 25
LATO SX	SZ 00192		SZ 00193 LATO DX
NOTE			

Ignis II 1.3 69Kw 1.3 4x4 69Kw 2003>		1.5 99Kw 1.5 4x4 99Kw 2003>	2003>
RIFERIMENTI ORIGINALI			
	4410286G30	4410186G00	
←	Lungh. Tot. = 620 mm	→	← Lungh. Tot. = 615 mm →
Cave 25	Cave 22	Fusello L/C 54mm	Cave interne 22 Cave 25
LATO SX	SZ 00190		SZ 00191 LATO DX
NOTE			

Liana 1.3 16v 66Kw 01>06		RIFERIMENTI ORIGINALI	
	4410254G51000	4410154G50000	
←	Cave 25	→	← Cave Int. 22 →
Cave 22		Cave 25	
LATO SX	SZ 00150		SZ 00151 LATO DX
NOTE ABS 42			

Maruti 800		RIFERIMENTI ORIGINALI	
			
←	Lungh. Tot. = 530 mm	→	← Lungh. Tot. = 702 mm →
Cave 22	Cave Int. 22	Cave Int. 22	Cave 22
LATO SX	SZ 00101		SZ 00102 LATO DX
NOTE			

S-X4

1.6 DDIS 66Kw

2007>



← Lungh. Tot. = 600 mm →
Cave 28 Cave 28

LATO SX

SZ 01190

RIFERIMENTI ORIGINALI

4410279J20

4410179J20



← Lungh. Tot. = 650 mm →
Cave interne 28 Cave 28

SZ 01191

LATO DX

NOTE

S-X4

1.6 WT 79Kw

06/06>



← Lungh. Tot. = 634 mm →
Cave 28 Cave 26

LATO SX

SZ 00130

RIFERIMENTI ORIGINALI

4410279J00

4410179J21



← Lungh. Tot. = 724 mm →
Cave Int. 26 Cave 28

SZ 00131

LATO DX

NOTE Fonico Ø 48

S-X4

1.9 DDIS 88Kw

06/06>



← Lungh. Tot. = 619 mm →
Cave 28 Cave 28

LATO SX

SZ 00132

RIFERIMENTI ORIGINALI

71746603
4410279J6071747566
4410179J60

← Lungh. Tot. = 590 mm →
Cave Int. 26 Cave 28

SZ 00133

LATO DX

NOTE Fonico Ø 48

S-X4

1.6 16v 78/88Kw
1.6 16v 4x4 88Kw2006>
2006>

← Lungh. Tot. = 610 mm →
Cave 28 Cave 26

LATO SX

FI 01160

RIFERIMENTI ORIGINALI



4410279J00
717427034410179JC0
717443873



← Lungh. Tot. = 700 mm →
Cave int. 26 Cave 28



FI 01161



LATO DX

NOTE

Splash		1.0 48/50Kw	2008>	
 <p>Lungh. Tot. = 643 mm Cave 25 Cave 22</p>	RIFERIMENTI ORIGINALI		 <p>Lungh. Tot. = 882 mm Cave 22 Cave 25</p>	
		4710017		4710013
LATO SX	OP 01005		OP 01006	LATO DX
NOTE				

Splash		1.3 CDTI 55Kw	2008>	
 <p>Lungh. Tot. = 631 mm Cave 25 Cave 26</p>	RIFERIMENTI ORIGINALI		 <p>Lungh. Tot. = 615 mm Cave Int. 22 Cave 25</p>	
		4410251K90 4711022		4410151K90 4710021
LATO SX	OP 01090		OP 01091	LATO DX
NOTE				

Swift		1.0 37/39/40Kw	1989>	
 <p>Lungh. Tot. = 680 mm Cave 23 Cave 22</p>	RIFERIMENTI ORIGINALI		 <p>Lungh. Tot. = 792 mm Cave 22 Cave 23</p>	
		4410280E00 4410280E01		4410180E00 4410180E01000
LATO SX	SZ 00109		SZ 00110	LATO DX
NOTE				

Swift		1.3 DDIS 16v 51/55Kw	05>11	
 <p>Lungh. Tot. = 635 mm Cave 25 Cave 22</p>	RIFERIMENTI ORIGINALI		 <p>Lungh. Tot. = 640 mm Cave Int. 22 Cave 25</p>	
		4410262J90 4410262J90000		4410162J90 4410162J91000
LATO SX	SZ 00127		SZ 00128	LATO DX
NOTE ABS 43D				

Swift

1.3 DDIS 55Kw

10/2010>



← Lungh. Tot. = 635 mm →
Cave 25 Cave 26

LATO SX

SZ 01127

RIFERIMENTI ORIGINALI

4410268L80000

44101-51K90
4410168L80000

← Lungh. Tot. = 615 mm →
Cave int. 22 Cave 25

SZ 01128

LATO DX

NOTE Fonico Ø 48

Swift

1.3 16v 68Kw

RIFERIMENTI ORIGINALI

4410263J52000

4410163J72000

← Lungh. Tot. = 650 mm →
Cave 25 Cave 22

LATO SX

SZ 00160

← Lungh. Tot. = 893 mm →
Cave 22 Cave 25

SZ 00161

LATO DX

NOTE ABS 43D

Swift

1.2 16v 69Kw

2010>

RIFERIMENTI ORIGINALI

4410268L01000

4410168L01000

← Lungh. Tot. = 660 mm →
Cave 23 Cave 22

LATO SX

SZ 00162

← Cave 22 →
Cave 23

SZ 00163

LATO DX

NOTE

Vitara

2.0 64Kw

96>99



← Lungh. Tot. = 536 mm →
Cave 26 Ø 105 3 Fori

LATO SX

SZ 00117

RIFERIMENTI ORIGINALI





← Lungh. Tot. = 610 mm →
Cave 26 Cave 26



SZ 00118

LATO DX



NOTE

Vitara	1.6 4X4 60Kw 1.9 d 50/55Kw	1995> 95>98	1.6 59/60/71/Kw	1988>1999
	RIFERIMENTI ORIGINALI			
← Lungh. Tot. = 490 mm Cave 26 Ø 105 3 Fori →			← Lungh. Tot. = 600 mm Cave 22 →	← Cave 26 →
LATO SX SZ 00113			SZ 00114	LATO DX

NOTE

Wagon R	1.0 39Kw 1.2 4WD 51Kw	03>05 98>00		
	RIFERIMENTI ORIGINALI			
← Cve 23 Cave 22 →	4410275F02000	4410175F01000 4410175F02000	← Cave 22 →	← Cave 23 →
LATO SX SZ 00156			SZ 00157	LATO DX

NOTE ABS 41

Wagon R+	1.3 DDIS 51Kw	2003>		
	RIFERIMENTI ORIGINALI			
← Lungh. Tot. = 600 mm Cave 23 Cave 22 →			← Lungh. Tot. = 600 mm Cave Int. 22 →	← Cave 23 →
LATO SX SZ 00121			SZ 00122	LATO DX

NOTE

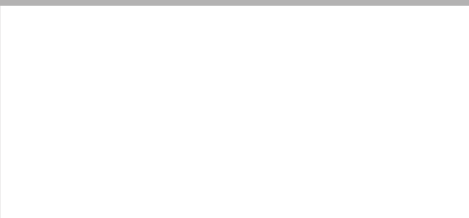
	RIFERIMENTI ORIGINALI			
				
← →			← →	
LATO SX				LATO DX

NOTE

Auris

1.4 D-4D 66Kw

03/07>



← Lungh. Tot. = 665 mm →
Cave 26 Cave 20

LATO SX

TO 00144

RIFERIMENTI ORIGINALI

4342002620

4341002580



← Lungh. Tot. = 945 mm →
Cave 20 Cave 26

TO 00145

LATO DX

NOTE

Auris

1.3 73/74Kw
1.4 WTI 71Kw05/09> 1.6 WTI 91Kw
03/07>

03/07>



← Lungh. Tot. = 665 mm →
Cave 26 Cave 20

LATO SX

TO 00146

RIFERIMENTI ORIGINALI

4320002610

4341002570

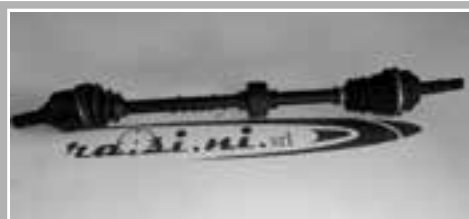

← Lungh. Tot. = 945 mm →
Cave 20 Cave 26

TO 00147

LATO DX

NOTE

Avenis

2.0 TDCI 66Kw

97>00



← Lungh. Tot. = 633 mm →
Cave 26 Cave 20

LATO SX

TO 00129

RIFERIMENTI ORIGINALI

4342005260

4341005241

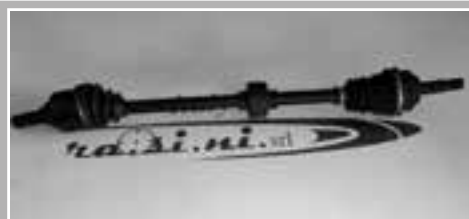

← Lungh. Tot. = 920 mm →
Cave 20 Cave 26

TO 00130

LATO DX

NOTE ABS 48D

Avenis

1.6 74/81Kw
1.6 VUT-i 81Kw97>03 1.8 81/95Kw
00>03 1.8 VVT-I 95Kw97>03 2.0 VVT-I 110Kw
00>03

00>03



← Lungh. Tot. = 615 mm →
Cave 26 Cave 20

LATO SX

TO 00113

RIFERIMENTI ORIGINALI

4342005300

4341005300







← Lungh. Tot. = 920 mm →
Cave 20 Cave 26



TO 00114



LATO DX

NOTE ABS 48D

Avensis 2.0 D-4D 85Kw 03>08		RIFERIMENTI ORIGINALI	
	4342005320	4341005370 4341005720	
Lungh. Tot. = 615 mm ← Cave 26 → Cave 24			Lungh. Tot. = 960 mm ← Cave 24 → Cave 26
LATO SX TO 00175			TO 00176 LATO DX
NOTE ABS 48			

Avensis 2.0 VVT-I 16v 108Kw 03>08		RIFERIMENTI ORIGINALI	
	4342005280	4341005350	
Lungh. Tot. = 630 mm ← Cave 26 → Cave 24			Lungh. Tot. = 945 mm ← Cave 24 → Cave 26
LATO SX TO 00177			TO 00178 LATO DX
NOTE ABS 48			

Avensis 2.0 VVT-I 81Kw 03>08		RIFERIMENTI ORIGINALI	
	4342005150	4341005330	
← Cave 26 →			← Cave 26 →
LATO SX TO 00179			TO 00180 LATO DX
NOTE			

Avensis 2.0 D-4D 91/93Kw 2009>		RIFERIMENTI ORIGINALI	
	4342005431	4341005481	
Lungh. Tot. = 625 mm ← Cave 30 → Cave 24		Fusello L/C 375mm	Lungh. Tot. = 1000 mm ← Cave 24 → Cave 30
LATO SX TO 00181			TO 00182 LATO DX
NOTE			

Avensis

2.0 D-4D 81Kw

1999 > 2003



← Lungh. Tot. = 620 mm →
Cave 26 Cave 23

LATO SX

TO 01006

RIFERIMENTI ORIGINALI

4342005140

4341005280



← Lungh. Tot. = 925 mm →
Cave 23 Cave 26

TO 01007

LATO DX

NOTE

Avensis Verso

2.0 D-4D 85Kw

01>05



← Lungh. Tot. = 620 mm →
Cave 30 Cave 24

LATO SX

TO 00183

RIFERIMENTI ORIGINALI

4342044070

4341044060

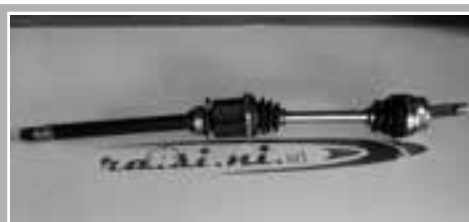

← Lungh. Tot. = 965 mm →
Cave 24 Cave 30

TO 00184

LATO DX

NOTE ABS 48

Avensis Verso

2.0 VVT-I 16v 110Kw

01>05



← Lungh. Tot. = 615 mm →
Cave 26 Cave 24

LATO SX

TO 00172

RIFERIMENTI ORIGINALI

4342044050

4341044040



← Lungh. Tot. = 935 mm →
Cave 24 Cave 26

TO 00173

LATO DX

NOTE ABS 48

Aygo

1.0 50Kw

2005>



← Lungh. Tot. = 650 mm →
Cave 24 Cave 23

LATO SX

CI 00197

RIFERIMENTI ORIGINALI



3272JY
434200H010
934200H0103273JR
434100H010



← Lungh. Tot. = 840 mm →
Cave 23 Cave 24



CI 00198



LATO DX

NOTE Fonico Ø 49,4



Aygo 1.4 D/4D 40Kw		2005>	
 <p>← Lungh. Tot. = 592 mm → Cave 24 Cave 23</p>	RIFERIMENTI ORIGINALI		 <p>← Lungh. Tot. = 896 mm → Cave 23 Cave 24</p>
	3272JZ 434200H020	3273JS 434100H020	
LATO SX	CI 01001		LATO DX
NOTE Fonico Ø 49,4			



Aygo 1.0 51Kw		2014>	
 <p>← Lungh. Tot. = 592 mm → Cave 24 Cave 23</p>	RIFERIMENTI ORIGINALI		 <p>← Lungh. Tot. = 896 mm → Cave 23 Cave 24</p>
	434200H040	434100H040	
LATO SX	TO 00185		LATO DX
NOTE			

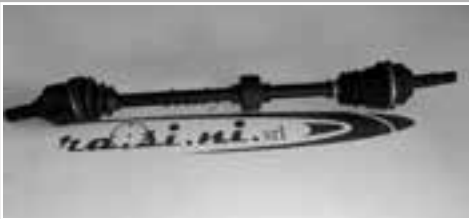

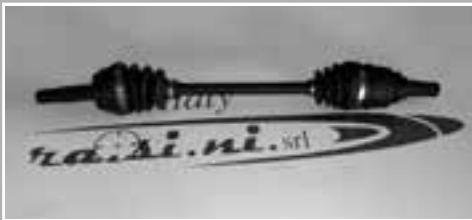
Carina 1.6 16v 73/78/79/85Kw 1.8 79Kw		92>97 95>97	
 <p>← Lungh. Tot. = 645 mm → Cave 26 Cave 23</p>	RIFERIMENTI ORIGINALI		 <p>← Lungh. Tot. = 950 mm → Cave 23 Cave 26</p>
	4342005010	4341005020 4341005060 4341020451	
LATO SX	TO 00107		LATO DX
NOTE			



Carina 2.0 D 54Kw		93>96	
 <p>← Lungh. Tot. = 645 mm → Cave 26 Cave 20</p>	RIFERIMENTI ORIGINALI		 <p>← Lungh. Tot. = 955 mm → Cave 20 Cave 26</p>
	4342005060	4341005080	
LATO SX	A = ABS 48	A = ABS 48	LATO DX
TO 00105 - TO 00105/A		TO 00106 - TO 00106/A	
NOTE ABS 48D su richiesta			



Celica	1.6 16v 78Kw 1.6 79Kw	95>97 1.8 79Kw 95>97	95>97
	RIFERIMENTI ORIGINALI		
← Lungh. Tot. = 619 mm → Cave 26 Cave 23	A = ABS 48	A = ABS 48	← Lungh. Tot. = 933 mm → Cave 23 Cave 26
LATO SX TO 00119 - TO 00119/A			TO 00120 - TO 00120/A LATO DX
NOTE ABS 48D su richiesta			



Celica	2.0 I 16v 125/129Kw	96>99	
	RIFERIMENTI ORIGINALI		
← Lungh. Tot. = 644 mm → Cave 26 Cave 20	A = ABS 48D	A = ABS 48D	← Lungh. Tot. = 930 mm → Cave 20 Cave 26
LATO SX TO 00109 - TO 00109/A			TO 00110 - TO 00110/A LATO DX
NOTE			

Celica	2.0 16v 115/129Kw	91>94	
	RIFERIMENTI ORIGINALI		
← Lungh. Tot. = 510 mm → Cave 26 Cave 20			← Lungh. Tot. = → Cave 20 Cave 26
LATO SX TO 00117			TO 00118 LATO DX
NOTE			

Corolla	1.4 63Kw 1.6	97>00 1.6 SI 84Kw 87>92 1.4 16v 71Kw	95>97 00>02
	RIFERIMENTI ORIGINALI		
← Lungh. Tot. = 607 mm → Cave 26 Cave 23	4342020112 A = ABS 48	4341020441 A = ABS 48	← Lungh. Tot. = 923 mm → Cave 23 Cave 26
LATO SX TO 00140 - TO 00140/A			TO 00141 - TO 00141/A LATO DX
NOTE			

Corolla		2.0 D4-D 66/85Kw	01>07	
 <p>Lungh. Tot. = 605 mm Cave 26 ← → Cave 24</p> <p>LATO SX TO 00142</p>	RIFERIMENTI ORIGINALI		 <p>Lungh. Tot. = 945 mm Cave 24 ← → Cave 26</p> <p>LATO DX TO 00143</p>	
	4342002300	4341002270		
NOTE ABS 48				



Corolla		1.4 D-4D 16v 66Kw	2010>	
 <p>Cave 26 ← → Cave 20</p> <p>LATO SX TO 00187</p>	RIFERIMENTI ORIGINALI		 <p>Cave 20 ← → Cave 26</p> <p>LATO DX TO 00188</p>	
	4342002620 4342002621	4341002580 4341002581		
NOTE Fonico Ø 61				

Corolla Verso		2.0 D-4D 66Kw	01>04	
 <p>Lungh. Tot. = 610 mm Cave 26 ← → Cave 24</p> <p>LATO SX TO 00189</p>	RIFERIMENTI ORIGINALI		 <p>Lungh. Tot. = 950 mm Cave 24 ← → Cave 26</p> <p>LATO DX TO 00190</p>	
	4342013030 434200F020	4341013050 434100F021		
NOTE ABS 48				

Corolla Verso		2.2 D-4D 100/130Kw	05>09	
 <p>Lungh. Tot. = 608 mm Cave 30 ← → Cave 24</p> <p>LATO SX TO 00170</p>	RIFERIMENTI ORIGINALI		 <p>Lungh. Tot. = 970 mm Cave 24 ← → Cave 30</p> <p>LATO DX TO 00171</p>	
	4342005372	4341005321		
NOTE ABS 48				

IQ		1.0 12v 50Kw	2008>		
		RIFERIMENTI ORIGINALI			
		4342074010	4341074020		
← Lungh. Tot. = 645 mm → Cave 24 Cave 23				← Lungh. Tot. = 903 mm → Cave 23 Cave 24	
LATO SX	TO 00191			TO 00192 LATO DX	
NOTE					

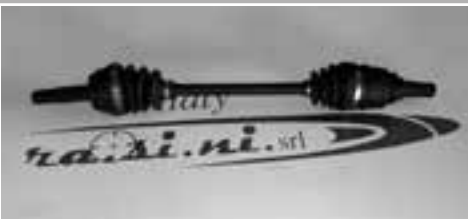

IQ		1.4 D-4D 66Kw	2008>		
		RIFERIMENTI ORIGINALI			
		4342052250	4341074010		
← →				← →	
LATO SX	TO 00193			TO 00194 LATO DX	
NOTE					

Picnic		2.0 94Kw	96>01		
		RIFERIMENTI ORIGINALI			
		4342020383 4342020423	4341020543 4241020583		
← Lungh. Tot. = 625 mm → Cave 26 Cave 20				← Lungh. Tot. = 910 mm → Cave 20 Cave 26	
LATO SX	TO 00123			TO 00124 LATO DX	
NOTE					



Prius		1.497 57Kw	03>09		
		RIFERIMENTI ORIGINALI			
		43420-47020	43410-47020		
← Lungh. Tot. = 657 mm → Cave 26 Cave 20				← Lungh. Tot. = 918 mm → Cave 20 Cave 26	
LATO SX	TO 00148			TO 00149 LATO DX	
NOTE					

RAV 4 I		2.0 16v 95Kw	95>00	
		RIFERIMENTI ORIGINALI		
		4342042013 4342042023	4341042013 4341042023	
← Lungh. Tot. = 575 mm → Cave 26 Cave 23		ABS 48		← Lungh. Tot. = 580 mm → Cave 23 Cave 26
LATO SX	TO 00195		TO 00196	LATO DX

NOTE

RAV 4 II		2.0 D 85Kw	01>05	
		RIFERIMENTI ORIGINALI		
		4342042140	4341042120	
← Lungh. Tot. = 585 mm → Cave 26 Cave 23		A = ABS 48	Fusello L/C 422mm A = ABS 48	← Lungh. Tot. = 1005 mm → Cave 23 Cave 26
LATO SX	TO 00115 - TO 00115/A		TO 00116 - TO 00116/A	LATO DX

NOTE

RAV 4 III		2.2 D4-D 100/130Kw	2006>	
		RIFERIMENTI ORIGINALI		
		4342042200	4341042210	
← Lungh. Tot. = 627 mm → Cave 30 Cave 24			L/C 375	← Lungh. Tot. = 1010 → Cave 24 Cave 30
LATO SX	TO 00150		TO 00151	LATO DX

NOTE Fonico Ø 62,6

RAV 4 IV		2.0 D-4D 16v 91/100Kw	2012>	
		RIFERIMENTI ORIGINALI		
		4342042200	4341042260	
← Lungh. Tot. = 620 mm → Cave 30 Cave 24				← Cave 24 Cave 30 →
LATO SX	TO 00197		TO 00198	LATO DX

NOTE

Urban Cruiser 4x4 1.3 VVT-I 74Kw

2010>



← Lungh. Tot. = 655 mm →
Cave 26 Cave 20

LATO SX **TO 00152**

RIFERIMENTI ORIGINALI

4342052210

4341052290



← Lungh. Tot. = 897 mm →
Cave 20 Cave 26

TO 00153 LATO DX

NOTE

Verso

2.0 D-4D 91Kw

2012>



← Lungh. Tot. = 615 mm →
Cave 30 Cave 24

LATO SX **TO 01004**

RIFERIMENTI ORIGINALI

434200F080
434200F081434100F070
434100F071

Fusello L/C 370mm



← Lungh. Tot. = 995 mm →
Cave 24 Cave 30

TO 01005 LATO DX

NOTE

Yaris

1.0 16v 48/50Kw

1999>



← Lungh. Tot. = 652 mm →
Cave 24 Cave 23

LATO SX **TO 00125 - TO 00125/A**

RIFERIMENTI ORIGINALI

4342052100
43420521104341052100
4341052110Paraolio L/C Ø 38
Fabb. Japan
A = ABS 48Paraolio L/C Ø 38
Fabb. Japan
A = ABS 48

← Lungh. Tot. = 870 mm →
Cave 23 Cave 24

TO 00126 - TO 00126/A LATO DX

NOTE ABS 48D su richiesta

Yaris

1.0 16v 48/50Kw

1999>



← Lungh. Tot. = 650 mm →
Cave 24 Cave 23

LATO SX **TO 00101 - TO 00101/A**

RIFERIMENTI ORIGINALI

434200D010
434200D020434100D010
434100D020Paraolio L/C Ø 38
Fabb. Francia
A = ABS 48Paraolio L/C Ø 38
Fabb. Francia
A = ABS 48

← Lungh. Tot. = 867 mm →
Cave 23 Cave 24

TO 00102 - TO 00102/A LATO DX

NOTE ABS 48D su richiesta

Yaris	1.3 VVT-I 64Kw 1.5 TS 77/78Kw	2002> 01>05	RIFERIMENTI ORIGINALI	
	434200D080	434100D080		
← Lungh. Tot. = 635 mm → Cave 24 Cave 23	Paraolio L/C Ø 34 A = ABS 48	Paraolio L/C Ø 34 A = ABS 48	← Lungh. Tot. = 876 mm → Cave 23 Cave 24	
LATO SX TO 00127 - TO 00127/A			TO 00128 - TO 00128/A LATO DX	

NOTE ABS 48D su richiesta

Yaris	1.4 D 55Kw 1.5 VVT 77/78Kw	2001> 2001>	RIFERIMENTI ORIGINALI	
← Lungh. Tot. = 640 mm → Cave 24 Cave 23	Paraolio L/C Ø 34 A = ABS 48	Paraolio L/C Ø 34 A = ABS 48	← Lungh. Tot. = 875 mm → Cave 23 Cave 24	
LATO SX TO 00111 - TO 00111/A			TO 00112 - TO 00112/A LATO DX	

NOTE ABS 48D su richiesta

Yaris	1.0 51Kw	2011>	RIFERIMENTI ORIGINALI	
	434200D390	434100D431		
← Lungh. Tot. = 670 mm → Cave 26 Cave 23			← Lungh. Tot. = 886 mm → Cave 23 Cave 26	
LATO SX TO 00199			TO 01001 LATO DX	

NOTE

Yaris	1.4 D-4D 66Kw	2011	RIFERIMENTI ORIGINALI	
	434200D322	434100D292		
← Lungh. Tot. = 658 mm → Cave 26 Cave 23			← Lungh. Tot. = 897 mm → Cave 23 Cave 26	
LATO SX TO 01002			TO 01003 LATO DX	

NOTE

Yaris II		1.0 VVT-I 51Kw 1.3 VVT-I 64Kw	06>12 06>12		
	RIFERIMENTI ORIGINALI				
	434200D170 434200D370	4342052280 434100D170 434100D380			
← Lungh. Tot. = 670 mm Cave 26	→ Cave 23	Paraolio L/C Ø 34	Paraolio L/C Ø 34	← Lungh. Tot. = 885 mm Cave 23	→ Cave 26
LATO SX TO 00166				TO 00167 LATO DX	

NOTE Fonico Ø 55

Yaris II		1.4 D 66Kw	06>09		
	RIFERIMENTI ORIGINALI				
	434200D180 434100D180B	434100D180 434100D180-D			
← Lungh. Tot. = 654 mm Cave 26	→ Cave 20	Paraolio L/C Ø 35	Paraolio L/C Ø 35	← Lungh. Tot. = 894 mm Cave 20	→ Cave 26
LATO SX TO 00131				TO 00132 LATO DX	



NOTE Fonico Ø 55

Yaris Verso		1.3 VVT I 62/63Kw	1999>		
	RIFERIMENTI ORIGINALI				
← Lungh. Tot. = 650 mm Cave 24	→ Cave 23	A = ABS 48	A = ABS 48	← Lungh. Tot. = 867 mm Cave 23	→ Cave 24
LATO SX TO 00101 - TO 00101/A				TO 00102 - TO 00102/A LATO DX	



NOTE

Yaris Verso		1.3 62/63Kw 1.4 D 55Kw	99>05 01>05	1.4 D-4D 1.5 VVT-I 77/78Kw	01>05 03>05
	RIFERIMENTI ORIGINALI				
	434200080	434100D080			
← Lungh. Tot. = 640 mm Cave 24	→ Cave 23	A = ABS 48	A = ABS 48	← Lungh. Tot. = 875 mm Cave 23	→ Cave 24
LATO SX TO 00111 - TO 00111/A				TO 00112 - TO 00112/A LATO DX	



NOTE

Bora	1.4 16v 55Kw 1.6 74Kw	2000> 1.9 SDI 50Kw 1998>	1998>
	RIFERIMENTI ORIGINALI		
← Lungh. Tot. = 554 mm Cave 36 →	1J0407271AH 1J0407271AM 1J0407271Q	1J0407272BL	← Lungh. Tot. = 822 mm Cave 36 →
LATO SX	VW 00117		VW 00118 LATO DX



NOTE

Bora	1.8 92Kw 1.9 TDI 66/74/81Kw	1998> 2.0 85Kw 1998>	1997>
	RIFERIMENTI ORIGINALI		
← Lungh. Tot. = 556 mm Cave 36 →	1J0407271JL 1J0407453DX	1J0407272 1J0407272AT	← Lungh. Tot. = 825 mm Cave 36 →
LATO SX	VW 00119		VW 00120 LATO DX



NOTE

Bora	1.9 TDI 74/85/96Kw 2.3 V5 Aut. 110Kw	1997>	1997>
	RIFERIMENTI ORIGINALI		
← Lungh. Tot. = 520 mm Cave 36 →	1J0407271CG 1J0407271EP 1J0407271ES 1J0407271FD	1J0407272BJ 1J0407272GC 1J0407272GD 1J0407272KT	← Lungh. Tot. = 810 mm Cave 36 →
LATO SX	VW 00121		VW 00122 LATO DX



NOTE

Caddy	1.5 51Kw 1.6 55Kw	82>92 1.6 D 40Kw 82>92 1.8 70Kw	82>92 82>92
	RIFERIMENTI ORIGINALI		
← Lungh. Tot. = 540 mm Cave 22 →	191407271B	191407274RX	← Lungh. Tot. = 760 mm Cave 22 →
LATO SX	SE 00101		SE 00110 LATO DX



NOTE

Caddy	1.7 SDI 42Kw 1.9 D 47Kw	1996> 1.9 SDI 47Kw 1995>	1995>
	RIFERIMENTI ORIGINALI		
	191407271A 191407271B 191407271L 191407271P	191407272A 191407272AC 191407272AE 191407278RX	
← Lungh. Tot. = 540 mm → Cave 22 Ø 94			← Lungh. Tot. = 775 mm → Ø 94 Cave 22
LATO SX	VW 00103		VW 00102 LATO DX

NOTE

Caddy	1.8 1.9 TDI 66Kw	1997> 1997>	
	RIFERIMENTI ORIGINALI		
	191407271HX 191407271S 191407271T	191407272AF 191407272AG 191407274CX	
← Lungh. Tot. = 535 mm → Cave 22 Ø 100			← Lungh. Tot. = 768 mm → Ø 100 Cave 22
LATO SX	SE 00115		SE 00116 LATO DX

NOTE

Caddy	1.9 TDI 77Kw	2004>	
	RIFERIMENTI ORIGINALI		
	1J0407271CG 1J0407271EP 1J0407271ES 1J0407271FD	1J0407272BJ 1J0407272GC 1J0407272GD 1J0407272KT	
← Lungh. Tot. = 520 mm → Cave 36 Ø 108			← Lungh. Tot. = 810 mm → Ø 108 Cave 36
LATO SX	VW 00121		VW 00122 LATO DX

NOTE

Caddy	1.6 C/A 6 Marce 1.6 FSI.C/A.6.Marce	2.0 FSI 75/80/110Kw C/A	2013>
	RIFERIMENTI ORIGINALI		
	1K0407271BD	1K0407272FS 1K0407272KB 1K0407452QX	
← Lungh. Tot. = 585 mm → Cave 36 Cave 26			← Lungh. Tot. = 880 mm → Cave 26 Cave 36
LATO SX	VW 00198		VW 00199 LATO DX

NOTE

Eos	1.6 C/A 6 Marce 1.6 FSI.C/A.6.Marce	2.0 FSI 75/80/110Kw C/A	2013>
RIFERIMENTI ORIGINALI		RIFERIMENTI ORIGINALI	
1K0407271BD		1K0407272FS 1K0407272KB 1K0407452QX	
← Lungh. Tot. = 585 mm → Cave 36 Cave 26		← Lungh. Tot. = 880 mm → Cave 26 Cave 36	
LATO SX	VW 00198	VW 00199	LATO DX

NOTE

Fox	1.2 40/44Kw	2005>	
RIFERIMENTI ORIGINALI		RIFERIMENTI ORIGINALI	
6Q0407271AS 6Q0407451DX		6Q0407272DS 6Q0407272BC 6Q0407452NX	
← Lungh. Tot. = 501 mm → Cave 20 Cave 94		← Lungh. Tot. = 755 mm → Cave 94 Cave 20	
LATO SX	SK 00112	SK 00113	LATO DX

NOTE

Fox	1.2 40Kw	2005>	
RIFERIMENTI ORIGINALI		RIFERIMENTI ORIGINALI	
6Q0407271AT 6Q0407451DX		6Q0407272BV 6Q0407452FX	
← Lungh. Tot. = 501 mm → Cave 36 Fil. 16x1,5 Ø 94		← Lungh. Tot. = 755 mm → Ø 94 Fil. 16x1,5 Cave 36	
LATO SX	VW 00168	VW 00169	LATO DX

NOTE

Fox	1.4 TDI 51Kw	2005>	
RIFERIMENTI ORIGINALI		RIFERIMENTI ORIGINALI	
6Q0407271DJ 6Q0407451PX 6QE407271J		6Q0407272DM 6Q0407452QX 6QE407272P	
← Lungh. Tot. = 502 mm → Cave 36 Fil. 16x1,5 Ø 94		← Lungh. Tot. = 760 mm → Ø 94 Cave 36 Fil. 16x1,5	
LATO SX	VW 00181	VW 00182	LATO DX

NOTE

Golf

1.6 C/A 6 Marce
1.6 FSI.C/A.6.Marce

2.0 FSI 75/80/110Kw C/A 2013>

RIFERIMENTI ORIGINALI

1K0407271BD

1K0407272FS
1K0407272KB
1K0407452QX← Lungh. Tot. = 585 mm →
Cave 36 Cave 26← Lungh. Tot. = 880 mm →
Cave 26 Cave 36

LATO SX

VW 00198

VW 00199

LATO DX

NOTE

Golf II

1.0 33Kw
1.3 40/43Kw83>92
83>92

RIFERIMENTI ORIGINALI

191407271N
1H0407271F
1H0407271FX191407272A
191407272AC
191407272AE
191407278RX← Lungh. Tot. = 562 mm →
Cave 22 Ø 94← Lungh. Tot. = 775 mm →
Ø 94 Cave 22

LATO SX

VW 00101

VW 00102

LATO DX

NOTE

Golf II

1.6 Diesel-TD
40/44/51/60Kw

83>91

1.6 51/55Kw
1.8 62/66Kw83>92
83>91

RIFERIMENTI ORIGINALI

191407271A
191407271B
191407271L
191407271P191407272A
191407272AC
191407272AE
191407278RX← Lungh. Tot. = 540 mm →
Cave 22 Ø 94← Lungh. Tot. = 775 mm →
Ø 94 Cave 22

LATO SX

VW 00103

VW 00102

LATO DX

NOTE

Golf III

1.4 40/44Kw

92>97

RIFERIMENTI ORIGINALI

1H0407271
1H0407271X1H0407272AG
1H0407274← Lungh. Tot. = 584 mm →
Cave 22 Ø 94← Lungh. Tot. = 780 mm →
Ø 94 Cave 22



LATO SX

VW 00107



VW 00108

LATO DX



NOTE

Golf III	1.4 40/44Kw 1.6 I Kat.	91>92 91>94	RIFERIMENTI ORIGINALI	
	1H0407271	1H0407272 1H0407272X 357407272E		
← Lungh. Tot. = 584 mm → Cave 22 Ø 94			← Lungh. Tot. = 796 mm → Ø 94 Cave 22	
LATO SX	VW 00105	VW 00106	LATO DX	



NOTE

Golf III	1.6 I Kat 55/74Kw 1.9 D 48Kw	94>97 91>97	RIFERIMENTI ORIGINALI	
	191407271N 1H0407271F 1H0407271FX	1H0407272 1H0407272X 357407272E		
← Lungh. Tot. = 562 mm → Cave 22 Ø 94			← Lungh. Tot. = 796 mm → Ø 94 Cave 22	
LATO SX	VW 00101	VW 00106	LATO DX	



NOTE

Golf III	1.8 55/66Kw 1.8 Aut. 55Kw	1991> 1991>	1.9 TD 55Kw 2.0 GTI Aut. 85Kw	1991>
	1H0407271A 1H0407271AX	1H0407272A 1H0407272MX 1H0407272M		
← Lungh. Tot. = 554 mm → Cave 22 Ø 100			← Lungh. Tot. = 792 mm → Ø 100 Cave 22	
LATO SX	VW 00111	VW 00112	LATO DX	



NOTE

Golf III	1.9 TDI 66/81Kw	93>97	RIFERIMENTI ORIGINALI	
	357407271EX 357407271GV	357407272B 357407272FX 357407272L 357407272M 1H0407272AG 1H0407274X		
← Lungh. Tot. = 554 mm → Cave 22 Ø 100			← Lungh. Tot. = 785 mm → Ø 100 Cave 22	
LATO SX	VW 00113	VW 00114	LATO DX	

NOTE

Golf III	2.0 GTI 85Kw 2.0 GTI 16V 110Kw	92>94 92>94	2.8 VR6 128Kw	92>97
	RIFERIMENTI ORIGINALI			
	1H0407271G	1H0407272C 1H0407272MV		
← Lungh. Tot. = 550 mm → Cave 36 Ø 100			← Lungh. Tot. = 785 mm → Ø 100 Cave 36	
LATO SX	VW 00115		VW 00116	LATO DX



NOTE

Golf IV	1.4 16V 55Kw 1.6 74Kw	1997> 1997>	1.9 SDI 50Kw	1997>
	RIFERIMENTI ORIGINALI			
	1J0407271AH 1J0407271AM 1J0407271Q	1J0407272BL		
← Lungh. Tot. = 554 mm → Cave 36 Ø 92			← Lungh. Tot. = 822 mm → Ø 92 Cave 36	
LATO SX	VW 00117		VW 00118	LATO DX

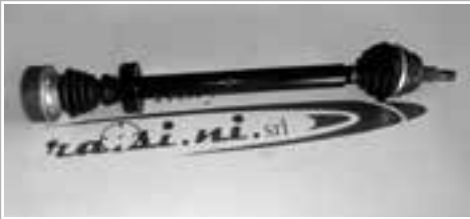

NOTE

Golf IV	1.9 TDI 66/74/81Kw 1.8 92Kw	1997> 1997>	2.0 85KW	1997>
	RIFERIMENTI ORIGINALI			
	1J0407271JD 1J0407453DX	1J0407272 1J0407272AT		
← Lungh. Tot. = 556 mm → Cave 36 Ø 100			← Lungh. Tot. = 825 mm → Ø 100 Cave 36	
LATO SX	VW 00119		VW 00120	LATO DX



NOTE

Golf IV	1.8 T JTI 132Kw 1.9 TDI 110Kw	01>05 00>05		
	RIFERIMENTI ORIGINALI			
	1K0407271BJ	8N0407272G 8N0407272P 8N0407452AX		
← Lungh. Tot. = 490 mm → Cave 36 Ø 108			← Lungh. Tot. = 770 mm → Ø 108 Cave 36	
LATO SX	VW 00162		VW 01001	LATO DX



NOTE Fonico Ø 59,3

Golf IV		1.9 TDI 85/96/110Kw	1998>	
 <p>← Lungh. Tot. = 520 mm Cave 36 Ø 108 →</p> <p>LATO SX VW 00121</p>	RIFERIMENTI ORIGINALI		 <p>← Lungh. Tot. = 810 mm Ø 108 Cave 36 →</p> <p>VW 00122 LATO DX</p>	
	1J0407271CG 1J0407271EP 1J0407271ES 1J0407271FD	1J0407272BJ 1J0407272GC 1J0407272GD 1J0407272KT		



NOTE

Golf IV		1.8 T 20v 110Kw	1997>	
 <p>← Lungh. Tot. = 545 mm Cave 36 Stellare Ø 72 Fori Ø 8 →</p> <p>LATO SX VW 00146</p>	RIFERIMENTI ORIGINALI		 <p>← Lungh. Tot. = 810 mm Stellare Ø 72 Fori Ø 8 Cave 36 →</p> <p>VW 00147 LATO DX</p>	
	1J0407271CJ	1J0407272DC		

NOTE

Golf IV		2.3 VR5 110Kw	97>00	
 <p>← Lungh. Tot. = 550 mm Cave 36 Stellare Ø 72 Fori Ø 10 →</p> <p>LATO SX VW 00148</p>	RIFERIMENTI ORIGINALI		 <p>← Lungh. Tot. = 810 mm Stellare Ø 72 Fori Ø 10 Cave 36 →</p> <p>VW 00149 LATO DX</p>	
	1J0407271H	1J0407452FX 1J0407452NX		

NOTE

Golf V		2.0 TDI 125Kw		
 <p>← Lungh. Tot. = 490 mm Cave 36 Ø 108 →</p> <p>LATO SX VW 00162</p>	RIFERIMENTI ORIGINALI		 <p>← Lungh. Tot. = 795 mm Ø 108 Cave 36 →</p> <p>AU 00161 LATO DX</p>	
	1K0407271BJ	1K0407272EN 1K0407272NJ		

NOTE

Golf V Plus

1.6 C/A 6 Marce
1.6 FSI.C/A.6.Marce

2.0 FSI 75/80/110Kw C/A 2013>

RIFERIMENTI ORIGINALI

1K0407271BD

1K0407272FS
1K0407272KB
1K0407452QX← Lungh. Tot. = 585 mm →
Cave 36 Cave 26← Lungh. Tot. = 880 mm →
Cave 26 Cave 36

LATO SX

VW 00198

VW 00199

LATO DX

NOTE

Golf V

1.4 TSI 103/125Kw

06>08

RIFERIMENTI ORIGINALI

1K0407271HH
1K0407761EY1K0407272KP
1K0407762HX← Lungh. Tot. = 525 mm →
Cave 36 Cave 108← Lungh. Tot. = 780 mm →
Cave 108 Cave 36

LATO SX

VW 01008

VW 01009

LATO DX

NOTE

Golf V

1.4 16v 55/59Kw

2003>

RIFERIMENTI ORIGINALI

1K0407271AP

1K0407272DM

← Lungh. Tot. = 560 mm →
Cave 36 Ø 94← Lungh. Tot. = 780 mm →
Ø 94 Cave 36

LATO SX

VW 00190

VW 00191

LATO DX

NOTE

Golf V

1.6 75Kw
1.6 75Kw Plus2004>
2005>

RIFERIMENTI ORIGINALI

1K0407271DJ

1K0407272HK
1K0407272JT← Lungh. Tot. = 545 mm →
Cave 36 Ø 100← Lungh. Tot. = 800 mm →
Ø 100 Cave 36

LATO SX

VW 00192

VW 00193

LATO DX

NOTE

Golf V

1.6 FSI Plus 85Kw
1.6 FSI 85Kw05>08
03>08← Lungh. Tot. = 560 mm →
Cave 36 Ø 100

LATO SX

VW 00194

RIFERIMENTI ORIGINALI

1K0407271DH
1K0407451BX
1K0407451MX1K0407272HB
1K0407272KC
1K0407452NX← Lungh. Tot. = 787 mm →
Ø 100 Cave 36

VW 00195

LATO DX

NOTE

Golf V

1.9 TDI 77/66Kw

2003>

← Lungh. Tot. = 520 mm →
Cave 36 Ø 100

LATO SX

VW 00170

RIFERIMENTI ORIGINALI

1K0407271AT

1K0407272CC

← Lungh. Tot. = 814 mm →
Ø 100 Cave 36

VW 00171

LATO DX

NOTE Fonico Ø 59,5

Golf V

1.9 TDI C. Aut. 77Kw
2.0 TDI C. Aut. 100/103Kw2003>
2003>← Lungh. Tot. = 480 mm →
Cave 36 fori Ø 10 - diam104

LATO SX

VW 00196

RIFERIMENTI ORIGINALI

1K0407271BF
1K0407271KA

1K0407272DQ

← Lungh. Tot. = 750 mm →
fori Ø 10 - diam 104 Cave 36

VW 00197

LATO DX

NOTE Per modelli a 6 marce

Golf V

2.0 TDI 100/103kw

2003>

← Lungh. Tot. = 490 mm →
Cave 36 Ø 108

LATO SX

VW 00162

RIFERIMENTI ORIGINALI

1K0407271BJ

← Lungh. Tot. = 490 mm →
Ø 108 Cave 36

VW 00162

LATO DX

NOTE Fonico Ø 59,3

Golf V

2.0 TDI C. Aut. 100/103kw 03>08
dal telaio n. 1K-5B068302← Lungh. Tot. = 480 mm →
Cave 36 Fori Ø10 Int. fori 104

LATO SX

AU 00157

RIFERIMENTI ORIGINALI

1K0407271KA
1K0407271BF
5Q0407272J1K0407272QE
1K0407272ER← Lungh. Tot. = 760 mm →
Fori Ø10 Int. fori 104 Cave 36

AU 00158

LATO DX

NOTE

Golf V

2.0 TDI C. Aut. 100/103kw 03>08
fino al telaio n. 1K-5B068301← Lungh. Tot. = 480 mm →
Cave 36 Fori Ø10 Int. fori 104

LATO SX

AU 00157

RIFERIMENTI ORIGINALI

1K0407271KA
1K0407271BF

1K0407272BR

← Lungh. Tot. = 800 mm →
Fori Ø10 Int. fori 104 Cave 36

AU 00169

LATO DX

NOTE

Golf V

2.0 TDI 103Kw 03>08
dal telaio n. 1K5B068302← Lungh. Tot. = 490 mm →
Cave 36 Ø 108

LATO SX

VW 00162

RIFERIMENTI ORIGINALI

1K0407271BJ

1K0407272EN
1K0407272NJ← Lungh. Tot. = 795 mm →
Ø 108 Cave 36

AU 00161

LATO DX

NOTE Fonico Ø 59,3

Golf V

1.4 16v 55/59Kw
1.4 TSI 66Kw03>08
03>06← Lungh. Tot. = 560 mm →
Cave 36 Ø 94

LATO SX

VW 00190

RIFERIMENTI ORIGINALI

1K0407271AP



1K0407272DM

← Lungh. Tot. = 780 mm →
Ø 94 Cave 36



VW 00191

LATO DX



NOTE

Golf VI		1.4 59Kw	10/08>	
 <p>← Lungh. Tot. = 560 mm → Cave 36 Ø 94</p>	RIFERIMENTI ORIGINALI		 <p>← Lungh. Tot. = 780 mm → Ø 94 Cave 36</p>	
	1K0407271AP	1K0407272DM		
LATO SX	VW 00190			VW 00191 LATO DX



NOTE

Golf VI		1.6 75Kw 1.6 75Kw Bifuel	10/08> 03/09>	
 <p>← Lungh. Tot. = 522 mm → Cave 36 Ø 100</p>	RIFERIMENTI ORIGINALI		 <p>← Lungh. Tot. = 800 mm → Ø 100 Cave 36</p>	
	1K0407271DR 1K0407271K	1K0407272HK 1K0407272BJ 1K0407452BV		
LATO SX	VW 01015			VW 00193 LATO DX

NOTE

Golf VI		1.6 TDI 66/77Kw 2.0 TDI 81Kw	02/09> 10/08>	
 <p>← Lungh. Tot. = 520 mm → Cave 36 Ø 100</p>	RIFERIMENTI ORIGINALI		 <p>← Lungh. Tot. = 814 mm → Ø 100 Cave 36</p>	
	1K0407271AT	1K0407272CC 1K0407272GK 1K0407452GX		
LATO SX	VW 00170			VW 00171 LATO DX

NOTE

Golf VI		2.0 TDI 103Kw 2.0 TDI 125Kw	10/08> 09>12	
 <p>← Lungh. Tot. = 490 mm → Cave 36 Ø 108</p>	RIFERIMENTI ORIGINALI		 <p>← Lungh. Tot. = 795 mm → Ø 108 Cave 36</p>	
	1K0407271BJ	1K0407272EN 1K0407272NJ		
LATO SX	VW 00162			AU 00161 LATO DX

NOTE

Golf VI

2.0 TDI 103Kw C. Aut.

01/08>



← Lungh. Tot. = 485 mm →
Cave 36

LATO SX

AU 00157

RIFERIMENTI ORIGINALI



← Lungh. Tot. = 755 mm →
Cave 36

AU 00158

LATO DX

NOTE

Golf VI

1.4 59Kw

08>12



← Lungh. Tot. = 560 mm →
Cave 36 Ø 94

LATO SX

VW 01024

RIFERIMENTI ORIGINALI

1K0407271AP
1K0407451X

1K0407272DM



← Lungh. Tot. = 782 mm →
Ø 94 Cave 36

VW 01025

LATO DX

NOTE

Golf VI

1.9 TDI 77Kw Plus

2008>

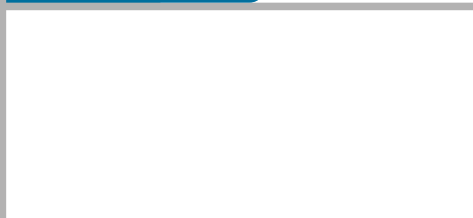

← Lungh. Tot. = 490 mm →
Cave 36 Cave 40

LATO SX

VW 01040

RIFERIMENTI ORIGINALI

1K0407271JL

1K0407272PC
1K0407762RX

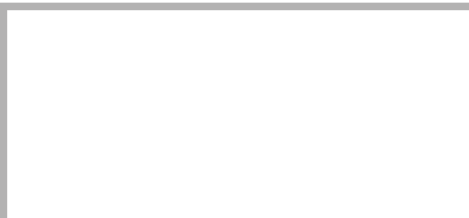

← Lungh. Tot. = 820 mm →
Cave Int. 40 Cave 36

VW 01041

LATO DX

NOTE

Golf VII

1.2 TSI 63Kw

2012>

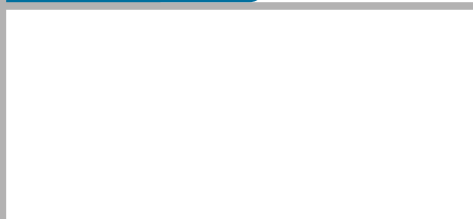

← →

LATO SX

VW 01030

RIFERIMENTI ORIGINALI

5Q0407761BX
5Q0407761QX

5Q0407762BX



← →



VW 01031



LATO DX

NOTE

Golf VII		1.2 TSI 16v 63/77Kw	2012>	
RIFERIMENTI ORIGINALI				
		1K0407271DQ	5Q0407272B	
← →				← →
LATO SX	VW 01032			VW 01033 LATO DX
NOTE				

Golf VII		2.0 TDI 110Kw	2012>	
RIFERIMENTI ORIGINALI				
		5Q0407271BM	5Q0407272K	
← →				← →
LATO SX	VW 01024			VW 01025 LATO DX
NOTE				

Jetta		2.0 TDI 100/103Kw	>10/10	
RIFERIMENTI ORIGINALI				
 <p>← Lungh. Tot. = 490 mm → Cave 36 Ø 108</p>		1K0407271BJ	1K0407272EN 1K0407272NJ 1K0407272PX	 <p>← Lungh. Tot. = 795 mm → Ø 108 Cave 36</p>
LATO SX	VW 00162			AU 00161 LATO DX
NOTE				

Jetta		1.6 FSI 85Kw	05>10	
RIFERIMENTI ORIGINALI				
 <p>← Lungh. Tot. = 560 mm → Cave 36 Ø 100</p>		1K0407271DH 1K0407451BX 1K0407451MX	1K0407272HB 1K0407272KC 1K0407452NX	 <p>← Lungh. Tot. = 787 mm → Ø 100 Cave 36</p>
LATO SX	VW 00194			VW 00195 LATO DX
NOTE				

Jetta		1.6 C/A 6 Marce 1.6 FSI.C/A.6.Marce	2.0 FSI 75/80/110Kw C/A	2013>
		RIFERIMENTI ORIGINALI		
		1K0407271BD	1K0407272FS 1K0407272KB 1K0407452QX	
← Lungh. Tot. = 585 mm → Cave 36 Cave 26		← Lungh. Tot. = 880 mm → Cave 26 Cave 36		
LATO SX	VW 00198			VW 00199 LATO DX

NOTE

Jetta		1.4 TSI 103/125Kw	06>08
		RIFERIMENTI ORIGINALI	
		1K0407271HH 1K0407761EY	1K0407272KP 1K0407762HX
← Lungh. Tot. = 525 mm → Cave 36 Cave 108		← Lungh. Tot. = 780 mm → Cave 108 Cave 36	
LATO SX	VW 01008		
		VW 01009	LATO DX



NOTE

Jetta		1.6 75Kw	>10/10
		RIFERIMENTI ORIGINALI	
		1K0407271DJ	1K0407272HK
← Lungh. Tot. = 545 mm → Cave 36 Ø 100		← Lungh. Tot. = 800 mm → Ø 100 Cave 36	
LATO SX	VW 00192		
		VW 00193	LATO DX



NOTE

Jetta		1.9 TDI 100/103Kw	>10/10
		RIFERIMENTI ORIGINALI	
		1K0407271AT	1K0407272CC
← Lungh. Tot. = 520 mm → Cave 36 Ø 100		← Lungh. Tot. = 814 mm → Ø 100 Cave 36	
LATO SX	VW 00170		
		VW 00171	LATO DX



NOTE

Lupo	1.0 37Kw 1.4 44Kw	1998> 1.4 16v 55/74Kw 1998> 1.4 FSI 77Kw	1998> 1.7 SDI 44Kw 1998>	1998>
	RIFERIMENTI ORIGINALI			
← Lungh. Tot. = 525 mm → Cave 22 Ø 92	6N0407271H 6N0407451BX	6E0407272H 6E0407452AX	← Lungh. Tot. = 750 mm → Ø 92 Cave 22	
LATO SX VW 00140			VW 00141 LATO DX	

NOTE

Lupo	1.4 TDI 55Kw	99>05		
	RIFERIMENTI ORIGINALI			
← Lungh. Tot. = 525 mm → Cave 22 Ø 72 Stellare	6X0407271K 6X0407451AX 6X0407451X	6X0407272E 6X0407452X	← Lungh. Tot. = 715 mm → Ø 72 Stellare Cave 22	
LATO SX VW 00135			VW 00136 LATO DX	



NOTE

New Beetle	1.9 TDI 66/74 Kw 1.6 75 Kw	1998> 2.0 85 Kw 1998>	1998>	
	RIFERIMENTI ORIGINALI			
← Lungh. Tot. = 556 mm → Cave 36 Ø 100	1J0407271JL	1J0407272 1J0407272AT	← Lungh. Tot. = 825 mm → Ø 100 Cave 36	
LATO SX VW 00119			VW 00120 LATO DX	



NOTE

Passat	1.6 C/A 6 Marce 1.6 FSI.C/A.6.Marce	2.0 FSI 75/80/110Kw C/A	2013>	
	RIFERIMENTI ORIGINALI			
← Lungh. Tot. = 585 mm → Cave 36 Cave 26	1K0407271BD	1K0407272FS 1K0407272KB 1K0407452QX	← Lungh. Tot. = 880 mm → Cave 26 Cave 36	
LATO SX VW 00198			VW 00199 LATO DX	



NOTE

Passat	1.9 TDI 81Kw 2.0 16v 110Kw	96>97 2.9 VR6 135Kw 94>97	
	RIFERIMENTI ORIGINALI		
	1J0407271JL	1J0407272 1J0407272AT	
← Lungh. Tot. = 556 mm → Cave 36 Ø 100			← Lungh. Tot. = 825 mm → Ø 100 Cave 36
LATO SX	VW 00119		VW 00120 LATO DX



NOTE

Passat	1.6 Kat. 51/81Kw 1.6 TD 59Kw	1990> 1.8 16v Aut. 55/82/102Kw 90>93 1.9 D-TD 50/55/66Kw	1988> 2.0 16v 110Kw 1989>	88>93
	RIFERIMENTI ORIGINALI			
	357407271A 357407271G 357407271GX 357407271HX	357407272 357407272B 357407272FX		
← Lungh. Tot. = 550 mm → Cave 22 Ø 100			← Lungh. Tot. = 787 mm → Ø 100 Cave 22	
LATO SX	VW 00123		VW 00124 LATO DX	

NOTE

Passat	1.9 TDI 66Kw	96>00	
	RIFERIMENTI ORIGINALI		
	8D0407451BV 8D0407451BX 8D0407451FX	8D0407272AN 8D0407452BV 8D0407452BX	
← Lungh. Tot. = 595 mm → Cave 33 Ø 130 Stellare			← Lungh. Tot. = 615 mm → Ø 130 Stellare Cave 33
LATO SX	VW 00125		VW 00126 LATO DX

NOTE ABS 45D

Passat	1.9 TD-TDI 81/96Kw 2.5 TDI 110Kw	96>00 2.8 V6 30v 142 Kw 98>05 2.0 TDI 100Kw	96>00 03>05
	RIFERIMENTI ORIGINALI		
	8D0407271AH 8D0407271DT 8D0407451CX 8D0407451CV	8D0407272DT 8D0407452EV 8D0407452CX 8D0407452CV	
← Lungh. Tot. = 602 mm → Cave 38 Ø 130 Stellare			← Lungh. Tot. = 621 mm → Ø 130 Stellare Cave 38
LATO SX	VW 00127		VW 00128 LATO DX

NOTE ABS 45D

Passat	1.6 74Kw	96>00	
	RIFERIMENTI ORIGINALI		
← Lungh. Tot. = 615 mm → Cave 33 Ø 100	8D0407271V 8D0407451X	8D0407452X 8D0407452V	← Lungh. Tot. = 636 mm → Ø 100 Cave 33
LATO SX	VW 00152		VW 00153 LATO DX
NOTE ABS 45D			



Passat	1.8 20v 92Kw 1.8 T 20v 110Kw	1996> 1996>	
	RIFERIMENTI ORIGINALI		
← Lungh. Tot. = 609 mm → Cave 33 Ø 108	8D0407271AQ 8D0407451AX	8D0407452AX 8D0407272AQ	← Lungh. Tot. = 635 mm → Ø 108 Cave 33
LATO SX	VW 00154		VW 00155 LATO DX
NOTE ABS 45D			

Passat	1.9 TDI 85Kw 1.9 TDI 74Kw	98>00 2001>	
	RIFERIMENTI ORIGINALI		
← Lungh. Tot. = 600 mm → Cave 33 Ø130 Stellare	8D0407451NX 8D0407271BQ	8D0407452MX 8D0407272BQ	← Lungh. Tot. = 620 mm → Ø130 Stellare Cave 33
LATO SX	VW 00156		VW 00157 LATO DX
NOTE ABS 45D			

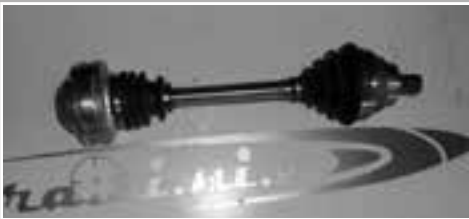
Passat			
	RIFERIMENTI ORIGINALI		
← Lungh. Tot. = mm → Cave Cave		3Q0407272C 3Q0407762DX	← Lungh. Tot. = 805 mm → Cave 108 Cave 36
LATO SX	VW 01002		VW 01003 LATO DX
NOTE			

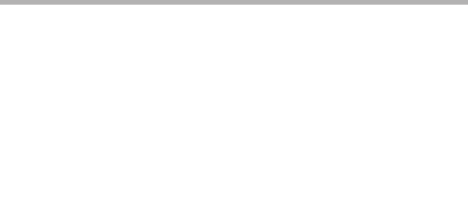
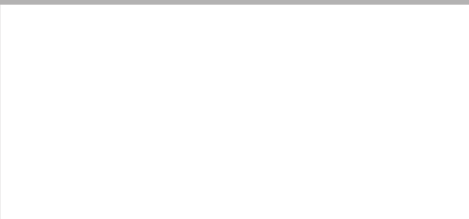
Passat	2.0 TDI 103Kw	2005>	
	RIFERIMENTI ORIGINALI		
← Lungh. Tot. = 490 mm → Cave 36 Ø 108	1K0407271BJ	1K0407272EN 1K0407272NJ	← Lungh. Tot. = 795 mm → Ø 108 Cave 36
LATO SX VW 00162			AU 00161 LATO DX
NOTE			

Passat	1.6 75Kw 1.6 TDI 77Kw	1.9 TDI 77Kw	
	RIFERIMENTI ORIGINALI		
← Lungh. Tot. = 520 mm → Cave 36 Ø 100	1K0407271AT	1K0407272CC	← Lungh. Tot. = 814 mm → Ø 100 Cave 36
LATO SX VW 00170			VW 00171 LATO DX
NOTE			

Polo	1.0 29/33Kw 1.3 44/55Kw	81>1994 81>1994	1.3 D 33Kw 1.3 GT 85Kw	81>1994 81>1994	1.4 D 35Kw >1994
	RIFERIMENTI ORIGINALI				
← Lungh. Tot. = 480 mm → Cave 20 Ø 92	871407271 871407271C	871407272D 871407272DX		← Lungh. Tot. = 732 mm → Ø 92 Cave 20	
LATO SX VW 00129				VW 00130 LATO DX	
NOTE					

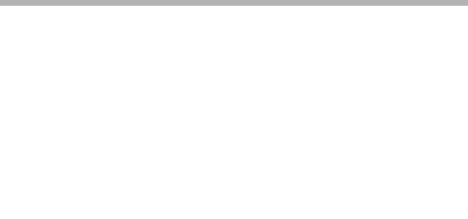
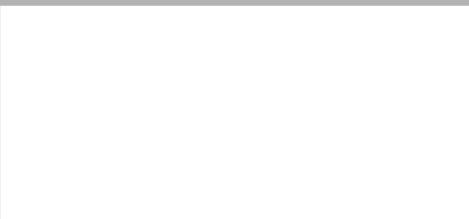

Polo	1.2 54/60Kw	02>09	
	RIFERIMENTI ORIGINALI		
← Lungh. Tot. = 501 mm → Cave 20 Cave 94	6Q0407271AS	6Q0407272DS	← Lungh. Tot. = 755 mm → Cave 94 Cave 20
LATO SX SK 00112			SK 00113 LATO DX
NOTE			

Polo 1.0		RIFERIMENTI ORIGINALI	
		6C0407271H	6C0407272H
← Lungh. Tot. = mm → Cave 36 Cave 26		← Lungh. Tot. = 805 mm → Cave 26 Cave 36	
LATO SX	VW 01004		VW 01005 LATO DX



NOTE

Polo 1.2 44/51/63Kw 1.4 44/51/63Kw		06/09> 06/09>	
		RIFERIMENTI ORIGINALI	
		6R0407761 6R0407761X	6R0407762
← Lungh. Tot. = 515 mm → Cave 36x1,5 Cave 92		← Lungh. Tot. = 775 mm → Cave 92 Cave 36x1,5	
LATO SX	VW 01006		VW 01007 LATO DX

NOTE

Polo 1.0 33/37Kw 1.3 40Kw		94>99 1.4 40/44Kw 94>99 1.6 55Kw	94>99 1.7 SDI 42/44Kw 94>99 1.9 D 47Kw	97>99 1.9 SDI 47Kw 94>99	96>99
		RIFERIMENTI ORIGINALI			
		6N0407271 6N0407271K	6N0407272 6N0407272K		
← Lungh. Tot. = 515 mm → Cave 22 Ø 92		← Lungh. Tot. = 740 mm → Ø 92 Cave 22			
LATO SX	VW 00131			VW 00132	LATO DX

NOTE

Polo 1.0 37Kw 1.4 40/44/55/74Kw		99>01 1.6 GTI 88Kw 99>01 1.7 SDI 42/44Kw	98>99 1.9 D 47Kw 99>00 1.9 SDI 47Kw	99>01 99>00
		RIFERIMENTI ORIGINALI		
		6N0407271H 6N0407451BX	6E0407272H 6E0407452AX 6Q0407272BC	
← Lungh. Tot. = 525 mm → Cave 22 Ø 94		← Lungh. Tot. = 750 mm → Ø 94 Cave 22		
LATO SX	VW 00133		VW 00134	LATO DX

NOTE

Polo

1.4 TDI 55Kw

99>02



← Lungh. Tot. = 525 mm →
Cave 22 Ø 72 Stellare

LATO SX

VW 00135

RIFERIMENTI ORIGINALI

6X0407271K
6X0407451AX
6X0407451X

6X0407272E
6X0407452X



← Lungh. Tot. = 715 mm →
Ø 72 Stellare Cave 22

VW 00136

LATO DX

NOTE

Polo

0.9 29Kw
1.3 40/44Kw75>81
75>81

← Lungh. Tot. = 480 mm →
Cave 20 Ø 92

LATO SX

VW 00150

RIFERIMENTI ORIGINALI

871407271CX
871407271

871407272CX
84072722



← Lungh. Tot. = 732 mm →
Ø 92 Cave 20

VW 00151

LATO DX

NOTE

Polo

1.4 TDI 55Kw
1.9 TDI 74Kw1999>
2001>

← Lungh. Tot. = 473 mm →
Cave 36 Stellare Ø 72 Fori Ø 10

LATO SX

VW 00160

RIFERIMENTI ORIGINALI

6Q0407271BE
6Q0407271BS
6Q0407271DB
6Q0407451FX

6Q0407272BH
6Q0407272BK
6Q0407452HX

Fil. 16x1,5

Fil. 16x1,5



← Lungh. Tot. = 762 mm →
Stellare Ø 72 Fori Ø 10 Cave 36

VW 00161

LATO DX

NOTE Fonico Ø 52

Polo

1.2 40/47Kw
1.2 51Kw2001> 1.4 16v 55/74Kw
1.4 FSI 63Kw1999> 1.9 SDI 47Kw
2002> 1.4 TDI 51Kw2001>
2005>

← Lungh. Tot. = 503 mm →
Cave 36 Ø 94

LATO SX

VW 00164

RIFERIMENTI ORIGINALI

6Q0407271AS
6Q0407271AT
6Q0407451DX
6Q0407451EX

6Q0407272BC
6Q0407272BD
6Q0407272BE
6Q0407452EX
6Q0407452FG
6Q0407452GX
6Q040772DM

Fil. 16x1,5

Fil. 16x1,5





← Lungh. Tot. = 753 mm →
Ø 94 Cave 36

VW 00165

LATO DX

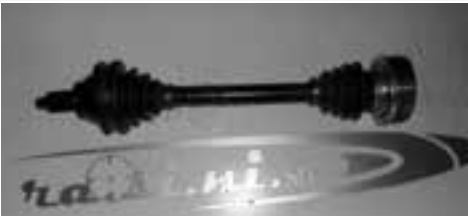

NOTE

Polo		1.2 TDI 55Kw 1.6 TDI 55/66/77Kw	09>14 09>14	
 <p>← Lungh. Tot. = 492 mm → Cave 36 Ø 100</p>	RIFERIMENTI ORIGINALI		 <p>← Lungh. Tot. = 785 mm → Ø 100 Cave 36</p>	
	6R0407761A 6R0407761AX	6R0407762A 6R0407762AX		
LATO SX	VW 01013		VW 01014	LATO DX

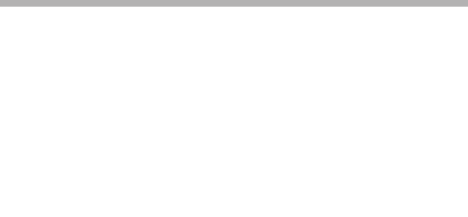
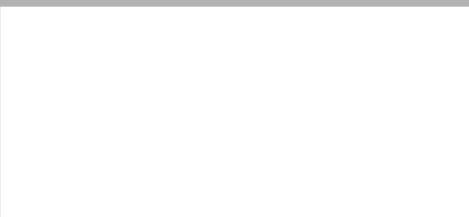
NOTE

Polo		1.2 TSI 16V 66/77Kw		
 <p>← Lungh. Tot. = mm → Cave Cave</p>	RIFERIMENTI ORIGINALI		 <p>← Lungh. Tot. = mm → Cave Cave</p>	
LATO SX	VW 01120		VW 01121	LATO DX

NOTE

Polo		1.4 TSI 103Kw	dal 2012>	
 <p>← Cave 36 →</p>	RIFERIMENTI ORIGINALI		 <p>← Cave 36 →</p>	
	6R0407761F	6R0407762F		
LATO SX	AU 00191		AU 00192	LATO DX

NOTE

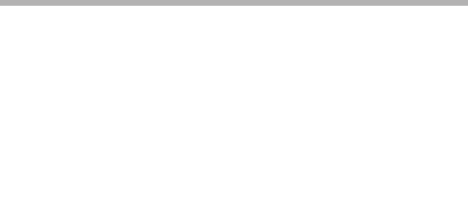
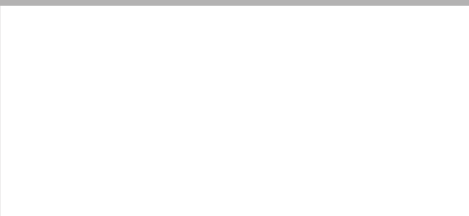
Polo		1.6 Bifuel 60Kw 1.6 Bifuel 81Kw	2011> 2014>	
 <p>← Lungh. Tot. = mm → Cave Cave</p>	RIFERIMENTI ORIGINALI		 <p>← Lungh. Tot. = mm → Cave Cave</p>	
LATO SX	VW 01122		VW 01123	LATO DX

NOTE

Polo VI

1.2 TSI 16v 66Kw

2014>



← Lungh. Tot. = 510 mm →
Cave 36 Ø 100

LATO SX

VW 01036

RIFERIMENTI ORIGINALI

6R0407761KX

6R0407762KX
6R0407762K

← Lungh. Tot. = 770 mm →
Ø 100 Cave 36

VW 01037

LATO DX

NOTE

Sharan

1.9 TDI 66/81Kw
2.0 85Kw96>00 | 2.3 107Kw
1995> | 2.8 V6 128Kw1997> |
95>00 |

← Lungh. Tot. = 620 mm →
Cave 38 Cave 26

LATO SX

FO 00126

RIFERIMENTI ORIGINALI

7M0407271J

7M0407272B

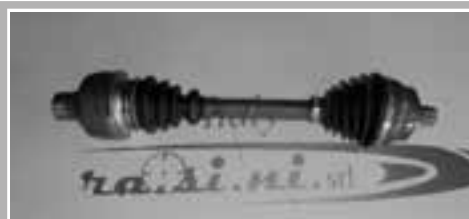

← Lungh. Tot. = 560 mm →
Cave Int. 35 Cave 38

FO 00127

LATO DX

NOTE ABS 48D

Sharan

1.9 TDI 85/96Kw
2.8 VR6 150Kw2000> |
2000> |

← Lungh. Tot. = 510 mm →
Cave 38 Ø 10 Int. Fori 104

LATO SX

FO 00125

RIFERIMENTI ORIGINALI

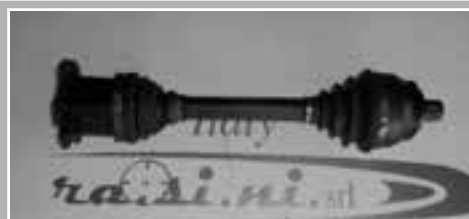
7M3407451A
7M3407271N
7M3407271

← Lungh. Tot. = 510 mm →
Ø 10 Int. Fori 104 Cave 38

FO 00125

LATO DX

NOTE ABS 48D

Tiguan

1.4 TSI 16v 110/118Kw

2011>

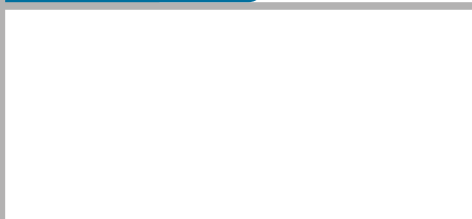

← Lungh. Tot. = 490 mm →
Cave 36 Cave 108

LATO SX

VW 01016

RIFERIMENTI ORIGINALI

5N0407763D

5N0407764S

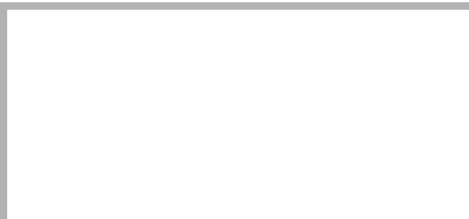

← Lungh. Tot. = 625 mm →
Cave 36 Cave 36



VW 01017

LATO DX



NOTE

Tiguan		2.0 TDI 100/103Kw	09/07>	
		RIFERIMENTI ORIGINALI		
		5N0407761P 5N0407761PX 5N0407763C	5N0407764L 5N0407764LX 5N0407764P	
← Lungh. Tot. = 565 mm → Cave 36 Cave 26		← Lungh. Tot. = 610 mm → Cave Int. 40 Cave 36		
LATO SX	VW 01018		VW 01019	LATO DX



NOTE

Tiguan		1.4 TSI 110/118Kw 1.4 TSI 90/92Kw	2008> 2010>	2.0TDI 81/103/110 2010>
		RIFERIMENTI ORIGINALI		
		5N0407766BX		
← Lungh. Tot. = 490 mm → Cave 36 Ø 108			← Lungh. Tot. = 795 mm → Ø 108 Cave 36	
LATO SX	VW 00162		AU 00174	LATO DX



NOTE

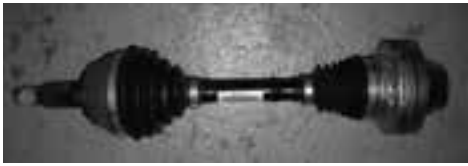

Touareg		2.5 R5 TDI 128Kw	03>10	
		RIFERIMENTI ORIGINALI		
		7L6407271B 7L6407271C		
← Lungh. Tot. = 525 mm → Cave 30 Ø 122				← Lungh. Tot. = 525 mm → Ø 122 Cave 38
LATO SX	VW 01010		VW 01010	LATO DX

NOTE Fonico Ø 64

Touareg		3.0 V6 TDI 165/176Kw 3.2 V6 162/177Kw	2004> 2002>	
		RIFERIMENTI ORIGINALI		
		7L0407271A 7L0407271B 7L0407271C		
← Lungh. Tot. = 525 mm → Cave 30 Ø 122				← Lungh. Tot. = 525 mm → Ø 122 Cave 30
LATO SX	VW 01011		VW 01011	LATO DX

NOTE

Touareg	4.2 228/257Kw 5.0 TDI 230/257Kw	2002> 6.0 W12 331Kw 2002>	05>10
	RIFERIMENTI ORIGINALI 7L6407271A		
← Lungh. Tot. = 518 mm Cave 30 Ø 122 →			← Lungh. Tot. = 518 mm Ø 122 Cave 30 →
LATO SX VW 01012			VW 01012 LATO DX
NOTE			

Touran	2.0 TDI 100/103Kw C.A. Dal telaio n. 1T-5083128	2003>	
	RIFERIMENTI ORIGINALI 1K0407271KA 1K0407271BF		
← Lungh. Tot. = 480 mm Cave 36 Fori Ø10 Int. fori 104 →			← Lungh. Tot. = 760 mm Fori Ø10 Int. fori 104 Cave 36 →
LATO SX AU 00157			AU 00158 LATO DX
NOTE Fonico Ø 59			

Touran	1.6 C/A 6 Marce 1.6 FSI.C/A.6.Marce	2.0 FSI 75/80/110Kw C/A	2013>
	RIFERIMENTI ORIGINALI 1K0407271BD		
← Lungh. Tot. = 585 mm Cave 36 Cave 26 →		1K0407272FS 1K0407272KB 1K0407452QX	← Lungh. Tot. = 880 mm Cave 26 Cave 36 →
LATO SX VW 00198			VW 00199 LATO DX
NOTE			

Touran	1.4 TSI 103/125Kw	06>08	
	RIFERIMENTI ORIGINALI 1K0407271HH 1K0407761EY		
← Lungh. Tot. = 525 mm Cave 36 Cave 108 →		1K0407272KP 1K0407762HX	← Lungh. Tot. = 780 mm Cave 108 Cave 36 →
LATO SX VW 01008			VW 01009 LATO DX
NOTE			

Touran

2.0 TDI 100/103Kw C.A. 2003>
Fino al Telaio 1T-5083127

RIFERIMENTI ORIGINALI

1K0407271KA
1K0407271BF

1K0407272BR



← Lungh. Tot. = 480 mm →
Cave 36 Fori Ø10 Int. fori 104

LATO SX

AU 00157

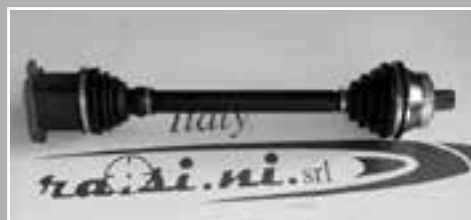

← Lungh. Tot. = 800 mm →
Fori Ø10 Int. fori 104 Cave 36

AU 00169

LATO DX

NOTE Fonico Ø 59

Touran

2.0 TDI 100/103kw 2003>
Fino al telaio n. 1T-5083127

RIFERIMENTI ORIGINALI

1K0407271BJ



← Lungh. Tot. = 490 mm →
Cave 36 Ø 108

LATO SX

VW 00162



← Lungh. Tot. = 490 mm →
Ø 108 Cave 36

VW 00162

LATO DX

NOTE Fonico Ø 59

Touran

RIFERIMENTI ORIGINALI

1K0407271BJ

1K0407272EN
1K0407272NJ



← Lungh. Tot. = 490 mm →
Cave 36 Ø 108

LATO SX

VW 00162



← Lungh. Tot. = 798 mm →
Ø 108 Cave 36

AU 00161

LATO DX

NOTE

Touran

RIFERIMENTI ORIGINALI

1K0407271AT

1K0407272CC



← Lungh. Tot. = 520 mm →
Cave 36 Ø 100

LATO SX

VW 00170





← Lungh. Tot. = 814 mm →
Ø 100 Cave 36



VW 00171

LATO DX



NOTE

Transporter	1.8 50Kw 1.9-1.9 TD 45/50Kw	1990> 2.0 51/62Kw 1990> 2.4 D 51/57Kw	1990> 2.5 I 81Kw 1990> 2.5 TDI 75Kw	1990> 1990>
	RIFERIMENTI ORIGINALI 701407451X 701407271M			
← Lungh. Tot. = 526 mm Cave 38	→ Ø 108	A = ABS 48	← Lungh. Tot. = 526 mm Ø 108	→ Cave 38
LATO SX	VW 00139 - VW 00139/A		VW 00139 - VW 00139/A LATO DX	

NOTE

Transporter	2.4 D 57Kw 2.5 I 81/85Kw	1994> 2.5 TDI 75Kw 1994> 2.8 VR6 103Kw	1995> 95>00
	RIFERIMENTI ORIGINALI 701407451A 701407271AC		
← Lungh. Tot. = 540 mm Cave 38	→ Ø 108	A = ABS 48	← Lungh. Tot. = 540 mm Ø 108
LATO SX	VW 00143 - VW 00143/A		VW 00143 - VW 00143/A LATO DX



NOTE



Transporter	2.5 TDI 111Kw	1998>2003	
	RIFERIMENTI ORIGINALI 7D0407271A		
← Lungh. Tot. = 550 mm Cave 38	→ Ø 108		← Lungh. Tot. = 550 mm Ø 108
LATO SX	VW 01020		VW 01020 LATO DX



NOTE ABS 48D

Transporter	1.9 63/63/75/77Kw 2.0 TDI 85Kw	2003>	
	RIFERIMENTI ORIGINALI 7H0407271T 7H0407451X		
← Lungh. Tot. = 645 mm Cave 38	→ Ø 108	Fusello L/C 205mm	← Lungh. Tot. = 860 mm Cave int. 26
LATO SX	VW 01022		VW 01023 LATO DX

NOTE

Transporter		2.0 103/132Kw	2010>	
 <p>← Lungh. Tot. = 646 mm → Cave 38 Cave 37</p> <p>LATO SX VW 01038</p>	RIFERIMENTI ORIGINALI OE7E040721L OE7E0407772DC Fusello L/C 430mm		 <p>← Lungh. Tot. = 1026 mm → Cave 37 Cave 38</p> <p>VW 01039 LATO DX</p>	
	NOTE			

Transporter		2.0 65/72/84/103/132Kw	2009>	
 <p>← Lungh. Tot. = 673 mm → Cave 38 Ø 108</p> <p>LATO SX VW 01026</p>	RIFERIMENTI ORIGINALI 7E0407271H 7E0407272AB 7E0407451X 7E0407452CX Fusello L/C 290mm		 <p>← Lungh. Tot. = 865 mm → Cave Int. 26 Cave 38</p> <p>VW 01027 LATO DX</p>	
	NOTE			

Transporter		2.5 TDI C. Aut. 96/128Kw	03>09	
 <p>← Lungh. Tot. = 640 mm → Cave 38 Cave Int. 26</p> <p>LATO SX VW 01028</p>	RIFERIMENTI ORIGINALI 7H0407271AB 7H0407272AF 7H0407271AM 7H0407272AP 7H0407272AS 7H0407452HX 7H0407452QX JZW407450QX		 <p>← Lungh. Tot. = 92 5 mm → Cave Int. 26 Cave 38</p> <p>VW 01029 LATO DX</p>	
	NOTE			

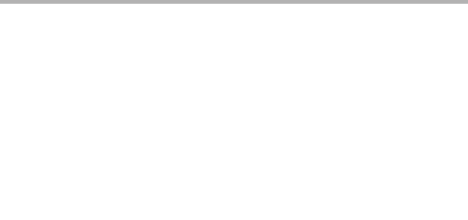
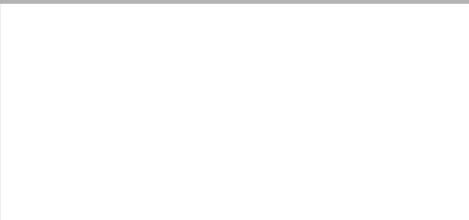
UP		1.0 44/50Kw	2011>	
 <p>← Lungh. Tot. = 655 mm → Cave 22 Cave 28</p> <p>LATO SX VW 01034</p>	RIFERIMENTI ORIGINALI 1S0407761B 1S0407762B 1S0407761BX 1S0407762BX 1S0407762DX		 <p>← Lungh. Tot. = 810 mm → Cave 28 Cave 22</p> <p>VW 01035 LATO DX</p>	
	NOTE			

Vento

1.4 40/44Kw

93>98



← Lungh. Tot. = 562 mm →
Cave 22 Ø 94

LATO SX

VW 00101

RIFERIMENTI ORIGINALI

191407271N
1H0407271F
1H0407271FX

1H0407272A
1H0407274



← Lungh. Tot. = 780 mm →
Ø 94 Cave 22

VW 00108

LATO DX

NOTE

Vento

1.6 I 55Kw
1.9 D 47Kw94>98
91>98

← Lungh. Tot. = 562 mm →
Cave 22 Ø 94

LATO SX

VW 00101

RIFERIMENTI ORIGINALI

191407271N
1H0407271F
1H0407271FX

1H0407272
1H0407272X
357407272E



← Lungh. Tot. = 796 mm →
Ø 94 Cave 22

VW 00106

LATO DX

NOTE

Vento

1.4 40/44Kw

91>92



← Lungh. Tot. = 584 mm →
Cave 22 Ø 94

LATO SX

VW 00105

RIFERIMENTI ORIGINALI

1H0407271

1H0407272
1H0407272X
357407272E



← Lungh. Tot. = 796 mm →
Ø 94 Cave 22

VW 00106

LATO DX

NOTE

Vento

1.4 40/44Kw
1.6 I 55Kw91>92
92>94

← Lungh. Tot. = 584 mm →
Cave 22 Ø 94

LATO SX

VW 00107

RIFERIMENTI ORIGINALI

1H0407271
1H0407271X

1H0407272AG
1H0407274





← Lungh. Tot. = 780 mm →
Ø 94 Cave 22



VW 00108

LATO DX



NOTE

Vento	1.8 66kw 1.9 TD 55Kw	91>98 91>98		
	RIFERIMENTI ORIGINALI			
	1H0407271A 1H0407271AX	1H0407272A 1H0407272AX 1H0407272M 1H0407272MX		
← Lungh. Tot. = 554 mm → Cave 22 Ø 100			← Lungh. Tot. = 792 mm → Ø 100 Cave 22	
LATO SX	VW 00111		VW 00112	LATO DX

NOTE

Vento	1.9 TDI 66/81Kw	93>98		
	RIFERIMENTI ORIGINALI			
	1H0407272AG 1H0407274X	357407272B 357407272FX 357407272L 357407272M		
← Lungh. Tot. = 554 mm → Cave 22 Ø 100			← Lungh. Tot. = 785 mm → Ø 100 Cave 22	
LATO SX	VW 00113		VW 00114	LATO DX

NOTE

Vento	2.0 85Kw 2.0 16v GTI 110Kw	92>98 92>98	2.8 VR6 120Kw	92>98
	RIFERIMENTI ORIGINALI			
	1H0407271G	1H0407272S		
← Lungh. Tot. = 550 mm → Cave 36 Ø 100			← Lungh. Tot. = 785 mm → Ø 100 Cave 36	
LATO SX	VW 00115		VW 00116	LATO DX

NOTE

	RIFERIMENTI ORIGINALI		
←			→
LATO SX			LATO DX



NOTE

440 - 460 - 480	1.7 I 78/80Kw 1.6 61-69 Kw	1986> 1986>		
	RIFERIMENTI ORIGINALI			
← Lungh. Tot. = 634 mm → Cave 22 Rullo Ø 30	9031180 A = ABS 44	9031175 90311754 A = ABS 44	← Lungh. Tot. = 740 mm → Cave Int. 23 Cave 22	
LATO SX VO 00101 - VO 00101/A			VO 00102 - VO 00102/A	LATO DX
NOTE ABS 44D su richiesta				

440 - 460 - 480	1.7 Turbo 1.9 Turbo Diesel	1988> 1996>	2.0 I	1988>
	RIFERIMENTI ORIGINALI			
← Lungh. Tot. = 640 mm → Cave 22 Rullo Ø 30	9031436 Campana Ø 90 A = ABS 44	9031437 Campana Ø 90 A = ABS 44	← Lungh. Tot. = 748 mm → Cave Int. 23 Cave 22	
LATO SX VO 00103 - VO 00103/A			VO 00104 - VO 00104/A	LATO DX
NOTE ABS 44D su richiesta				

850	Tutti i modelli Exc. C. Aut.			
	RIFERIMENTI ORIGINALI			
← Lungh. Tot. = 580 mm → Cave 26 Cave 26	9122567 9163589	9122568 9163588 Fusello L/C 507mm	← Lungh. Tot. = 1030 mm → Cave 26 Cave 26	
LATO SX VO 00105			VO 00106	LATO DX
NOTE ABS 48D				

C30	2.0 D 100/149Kw	10/06>		
	RIFERIMENTI ORIGINALI			
← Lungh. Tot. = 585 mm → Cave 36 Cave 26	1223785 1353398 1415778 1437541 3M51-3B437-AAF	1223723 1417775	← Lungh. Tot. = 925 mm → Cave 26 Cave 36	
LATO SX FO 00160			FO 00161	LATO DX
NOTE				

C30	1.6 74 Kw	10/06>		
	RIFERIMENTI ORIGINALI			
← Lungh. Tot. = 600 mm → Cave 36 Cave 26		4M51-3B436-JF	← Lungh. Tot. = 905 mm → Cave 26 Cave 36	
LATO SX	FO 00149		FO 00150	LATO DX
NOTE ABS 48D				

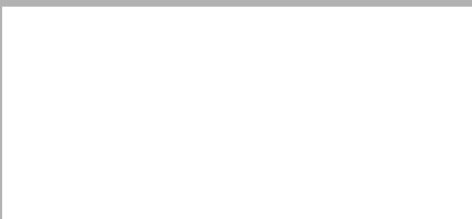
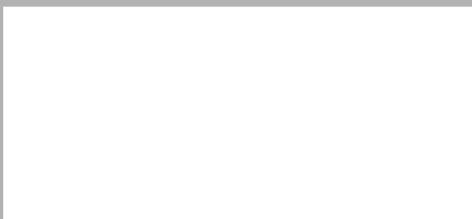
C30	1.6 D 80 Kw	10/06>		
	RIFERIMENTI ORIGINALI			
← Lungh. Tot. = 585 mm → Cave 36 Cave 26			← Lungh. Tot. = 925 mm → Cave 26 Cave 36	
LATO SX	VO 00143		VO 00144	LATO DX
NOTE				

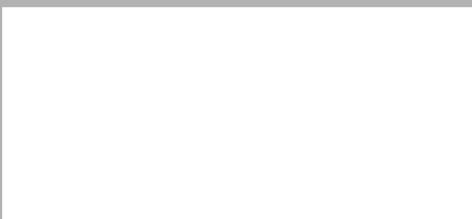
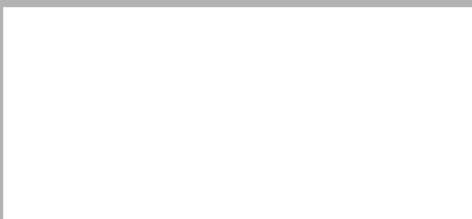
C30	2.0 D 100Kw	06>12		
	RIFERIMENTI ORIGINALI			
← Lungh. Tot. = 580 mm → Cave 36 Cave 26	3071770	30681131 3078004	← Lungh. Tot. = 920 mm → Cave 26 Cave 36	
LATO SX				LATO DX
NOTE				

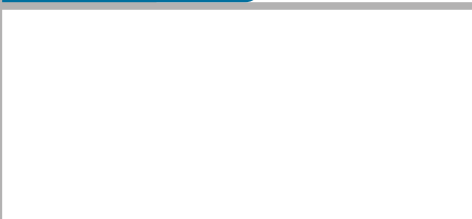
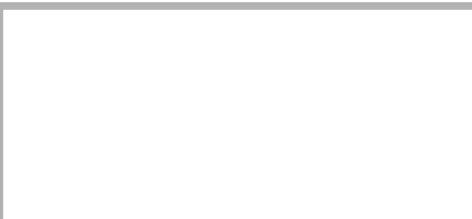
C70	2.0 D 100Kw	08>09		
	RIFERIMENTI ORIGINALI			
← Lungh. Tot. = 580 mm → Cave 36 Cave 26	3071770	30681131 3078004	← Lungh. Tot. = 920 mm → Cave 26 Cave 36	
LATO SX				LATO DX
NOTE				

C70 - S70 - V70

2.0 20v 93/132Kw
2.4 20v 106/125Kw1997>
1997>← Lungh. Tot. = 580 mm →
Cave 26 Cave 26LATO SX **VO 00190 - VO 00190/A**

RIFERIMENTI ORIGINALI

5125672
8601102
91229198601103
9122920
912680

Fusello L/C 527mm

← Lungh. Tot. = 1030 mm →
Cave 26 Cave 26**VO 00191 - VO 00191/A** LATO DX

NOTE

C70 - S70 - V70

2.0 20v 93/132Kw
2.4 20v 106/125Kw97>00
97>00← Lungh. Tot. = 550 mm →
Cave 26 Cave 26LATO SX **VO 00124**

RIFERIMENTI ORIGINALI

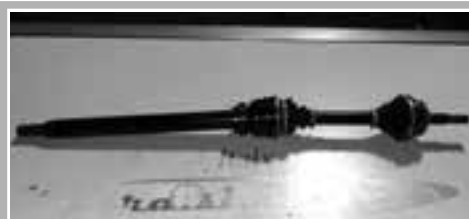
← Lungh. Tot. = 1028 mm →
Cave 26 Cave 26**VO 00125** LATO DX

NOTE ABS 48D

S40

1.6 74Kw

2005>

← Lungh. Tot. = 600 mm →
Cave 36 Cave 23LATO SX **FO 00149**

RIFERIMENTI ORIGINALI

4M51-3B436-JF

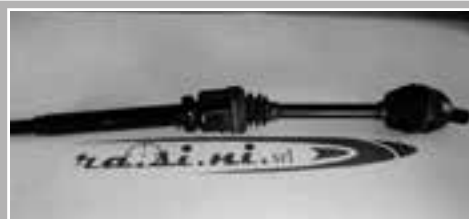
← Lungh. Tot. = 905 mm →
Cave 23 Cave 36**FO 00150** LATO DX

NOTE Fonico Ø 56

S40

2.0 D 100Kw

04>10

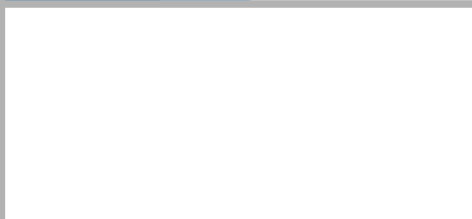
← Lungh. Tot. = 580 mm →
Cave 36 Cave 26

LATO SX



RIFERIMENTI ORIGINALI

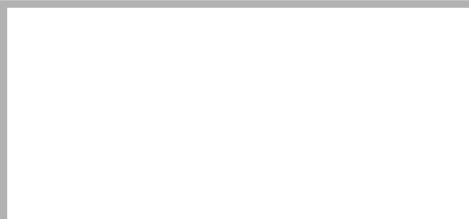

3071770



30681131
3078004← Lungh. Tot. = 920 mm →
Cave 26 Cave 36

LATO DX

NOTE

S40	1.6 D 81Kw	2005>		
	RIFERIMENTI ORIGINALI			
← Lungh. Tot. = 585 mm → Cave 36 Cave 26			← Lungh. Tot. = 925 mm → Cave 26 Cave 36	
LATO SX	FO 00143		FO 00144	LATO DX
NOTE				

S40	2.0 D 100Kw	2004>		
	RIFERIMENTI ORIGINALI			
← Lungh. Tot. = 585 mm → Cave 36 Cave 26	1437541 36000562 3M51-3B437-AAF 8603251	36000562 8603252	← Lungh. Tot. = 925 mm → Cave 26 Cave 36	
LATO SX	FO 00160		FO 00161	LATO DX
NOTE Fonico Ø 56				

S40 - V40	1.6 77/80Kw 1.8 16v 85Kw	1995> 1995>	2.0 16v 100/103Kw	1995>
	RIFERIMENTI ORIGINALI			
← Lungh. Tot. = 625 mm → Cave 25 Rullo Ø 30	8202072	8602095	← Lungh. Tot. = 810 mm → Cave Int. 23 Cave 25	
LATO SX	VO 00107 - VO 00107/A	A = ABS 43	VO 00108 - VO 00108/A	LATO DX
NOTE ABS 43D su richiesta				

S40 - V40	1.9 DI 75/85Kw	2000>2004		
	RIFERIMENTI ORIGINALI			
← Lungh. Tot. = 627 mm → Cave 25 Rullo Ø30	8251531	8251532	← Lungh. Tot. = 815 mm → Cave Int. 23 Cave 25	
LATO SX	VO 00116	Fusello L/C 397mm	VO 00117	LATO DX
NOTE ABS 43D Ø 82				

S60

1.6 D 84Kw

06/2010>



← Lungh. Tot. = mm →
Cave 36 Cave 26

LATO SX

VO 00162

RIFERIMENTI ORIGINALI

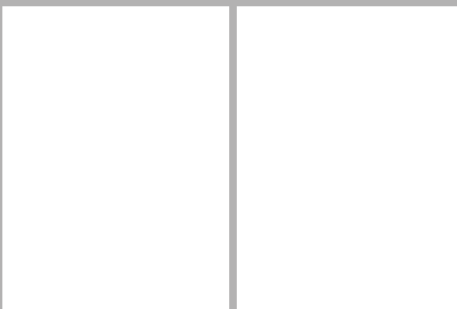

← Lungh. Tot. = mm →
Cave 26 Cave 36

VO 00163

LATO DX

NOTE

S60

2.4 103-125 kw
2.4 Bifuel 103 Kw2000>
2002>

← Lungh. Tot. = 556 mm →
Cave 36 Cave 26

LATO SX

VO 00160

RIFERIMENTI ORIGINALI



← Lungh. Tot. = mm →
Cave 26 Cave 36

VO 00161

LATO DX

NOTE A= ABS 48 D

S60

2.4 D5 96/120Kw

2001>



← Lungh. Tot. = 545 mm →
Cave 36 Cave 26

LATO SX

VO 00166

RIFERIMENTI ORIGINALI

8601855
86025778601856
8602578

Fusello L/C 510mm



← Lungh. Tot. = 999 mm →
Cave 26 Cave 36

VO 00167

LATO DX

NOTE ABS 48D

S80

2.4 103-125 Kw
2.5 154 Kw1997> 2.8 T6 24v 200 Kw
1997> 2.9 T6 147-150 Kw1997>
1997>

← Lungh. Tot. = 580 mm →
Cave 36 Cave 26

LATO SX

VO 00112

RIFERIMENTI ORIGINALI







← Lungh. Tot. = 1035 mm →
Cave 26 Cave 36



VO 00113

LATO DX

NOTE ABS 48D

S80		2.0 120 Kw 2.0 T 132-166 Kw	98>06 98>06		
RIFERIMENTI ORIGINALI					
	8251773 8603788 9181541	8251774 8603877 9181540			
← Lungh. Tot. = 550 mm → Cave 36 Cave 26	Fusello L/C 520mm		← Lungh. Tot. = 1015mm → Cave 26 Cave 36		
LATO SX	VO 00114		VO 00115	LATO DX	
NOTE ABS 48D					

V50		1.6 74Kw	01/2005>		
RIFERIMENTI ORIGINALI					
		4M51-3B436-JF			
← Lungh. Tot. = 600 mm → Cave 36 Cave 23			← Lungh. Tot. = 905 mm → Cave 23 Cave 36		
LATO SX	FO 00149		FO 00150	LATO DX	
NOTE Fonico Ø 56					

V50		1.6 D4 81Kw	01/2005>		
RIFERIMENTI ORIGINALI					
	1364029 1454214 5M51-3B437-SD	1223723 3M51-3B436-DAF			
← Lungh. Tot. = 585 mm → Cave 36 Cave 26			← Lungh. Tot. = 925 mm → Cave 26 Cave 36		
LATO SX	FO 00143		FO 00144	LATO DX	
NOTE					

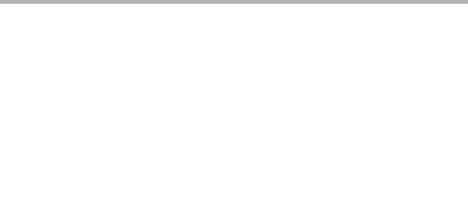
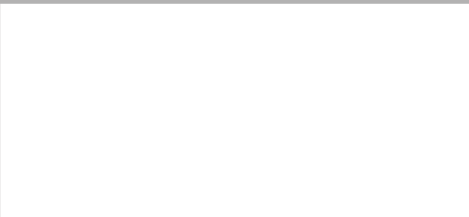
V50		2.0 D 100Kw	04>10		
RIFERIMENTI ORIGINALI					
	3071770	30681131 3078004			
← Lungh. Tot. = 580 mm → Cave 36 Cave 26			← Lungh. Tot. = 920 mm → Cave 26 Cave 36		
LATO SX				LATO DX	
NOTE					

V50

2.0 D 100/149Kw

2004>



← Lungh. Tot. = 585 mm →
Cave 36 Cave 26

LATO SX

FO 00160

RIFERIMENTI ORIGINALI

1223785
1353398
1415778
1437541
3M51-3B437-AAF

1223723
1417775

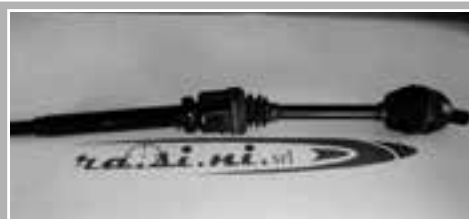

← Lungh. Tot. = 925 mm →
Cave 26 Cave 36

FO 00161

LATO DX

NOTE Fonico Ø 56

V70

2.5 TDI 103Kw

99>00

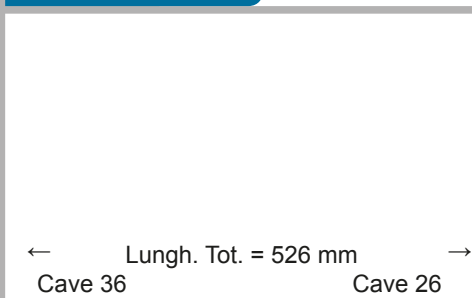

← Lungh. Tot. = 526 mm →
Cave 36 Cave 26

LATO SX

VW 00130

RIFERIMENTI ORIGINALI

8601573

8601574
8602608

Fusello L/C 527mm

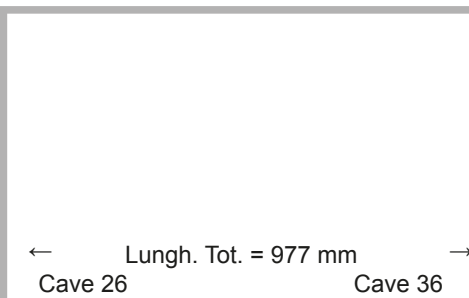

← Lungh. Tot. = 977 mm →
Cave 26 Cave 36

VW 00131

LATO DX

NOTE

XC70

2.4/D5 120Kw

2002>



← Lungh. Tot. = 553 mm →
Cave 36 Cave 26

LATO SX

VO 00126

RIFERIMENTI ORIGINALI

30783088
36000507
8603801

36000510
8603884



← Lungh. Tot. = 1007 mm →
Cave 26 Cave 36

VO 00127

LATO DX

NOTE ABS 48D

XC90

2.5 T.C.A. 154Kw
2.5 TD C.A. 120Kw02>07
02>07

← Lungh. Tot. = 581 mm →
Cave 36 Cave 26

LATO SX

VO 00128

RIFERIMENTI ORIGINALI

8601581

8601582



← Lungh. Tot. = 1031 mm →
Cave 26 Cave 36

VO 00129

LATO DX

NOTE ABS 48D

XC 90		2.4 20v D3 4x4 120Kw 2.4 20v D5 4x4 120/136Kw 06>11	
		RIFERIMENTI ORIGINALI	
		36000505 36000514	36000515
← Lungh. Tot. = 576 mm → Cave 40 Cave 26		← Lungh. Tot. = 1024 mm → Cave 26 Cave 40	
LATO SX VW 00140		VW 00141 LATO DX	

NOTE

		RIFERIMENTI ORIGINALI	
← →		← →	
LATO SX		LATO DX	

NOTE

		RIFERIMENTI ORIGINALI	
← →		← →	
LATO SX		LATO DX	

NOTE

		RIFERIMENTI ORIGINALI	
← →		← →	
LATO SX		LATO DX	

NOTE

