



Ricambi Rigenerati
di qualità superiore!

CATALOGO 2015



Distribuito da





LA BLOCK STEM SRL

È una giovane e dinamica realtà aziendale che offre un servizio di rigenerazione completa (da intendersi quindi sia delle parti meccaniche che di quelle elettroniche) di tutti i piantoni di sterzo provvisti di EPS (electric power steering - servosterzo elettrico) nonché di pompe elettroidrauliche e scatole guida elettromeccaniche.

Negli ultimi anni l'azienda ha notevolmente ampliato e consolidato le proprie quote di mercato, offrendo ai propri clienti una gamma di prodotti altamente affidabili, un servizio di consegna e ritiro celere e puntuale e, non da ultimo, l'assistenza di tecnici specializzati. Al fine di un ulteriore completamento di gamma, sono inoltre disponibili articoli non rigenerati bensì nuovi, provenienti da stock (quindi originali) oppure di altra manifattura (costruiti secondo ben determinate specifiche tecniche).

La Block Stem srl è ormai sinonimo di rigenerazione, precisa ed impeccabile, contraddistinta dalla tecnologia all'avanguardia che racchiude al suo interno. Infatti le competenze tecnologiche in ambito meccanico, elettronico ed elettrotecnico, abbinate alle attrezzature di produzione e di collaudo dedicate, costituiscono gli elementi essenziali e fondanti del nostro processo di rigenerazione.

Ci contraddistingue la notevole attenzione che riponiamo verso tutti i nostri prodotti, la cura dei dettagli e il rispetto dei rigorosi standard attentamente osservati in tutte le attività dell'azienda, volgendo una particolare cura alla riduzione dell'impatto ambientale.

Lo spirito giovane e innovativo, nonché l'assidua attenzione verso le richieste e le esigenze della nostra clientela, garantiscono un costante aggiornamento dell'offerta in termini di prodotti e servizi. L'area Ricerca e Sviluppo è infatti costantemente a lavoro per ottimizzare i processi di rigenerazione nonché l'innovazione degli stessi, al fine di offrire risposte concrete alle esigenze di un mercato in continua evoluzione.

I nostri valori si evidenziano nell'apertura mentale e nel rispetto che nutriamo per l'uomo e la società, nonché nella responsabilità con cui operano i nostri collaboratori. È infatti alle loro competenze ed alla passione con cui svolgono quotidianamente il loro lavoro, che dobbiamo il nostro successo.



PRECAUZIONI DI INSTALLAZIONE

Prima dell'installazione leggere con attenzione ed interamente le seguenti informazioni.

Prima dell'uscita dalla fabbrica il gruppo eps è stato accuratamente controllato e collaudato dall'azienda secondo procedure di qualità documentate ed è pertanto perfettamente funzionante. Il gruppo eps deve essere installato da personale istruito ed abilitato. Assicurarsi che il gruppo eps ordinato e recapitato sia conforme in tutte le parti e compatibile con quello presente a bordo veicolo (cfr. codice centralina, presenza di regolazione volante, ecc.). Prendere le necessarie precauzioni a preservare con cura gli interni del veicolo prima di eseguire tutte le operazioni di smontaggio e riattacco. Per un corretto funzionamento del gruppo eps, prima di procedere con l'installazione, consigliamo di verificare lo stato di carica della batteria, lo stato di ricarica dell'alternatore, l'eventuale ossidazione delle morsettiere dei cavi di massa e l'integrità di tutti i fusibili sulla tastiera. Non effettuare saldature o riparazioni al gruppo eps fornito ed in generale non apportare modifiche di qualsiasi natura non approvate dall'azienda, pena la decadenza della garanzia.



GENERALITÀ DI INSTALLAZIONE

Prima di procedere con le operazioni di smontaggio, si suggerisce di eseguire un controllo preliminare, al fine di verificare l'assenza di eventuali rumorosità, vibrazioni, anomalie di funzionamento o danneggiamenti pregressi delle parti collegate al gruppo eps (devio-luce, volante, carterini, ecc.) e verificare che sul quadro strumenti non ci siano spie accese relative ad altre anomalie. Solo nel caso in cui tale controllo non dovesse evidenziare difettosità, procedere con lo smontaggio.

1. Posizionare il volante a ruote dritte e chiudere i vetri nel caso siano provvisti di comando elettrico per il sollevamento.
2. Annotare eventuali codici presenti come ad esempio quello dell'autoradio.
3. Nel caso di vetture dotate di chiave d'avviamento elettronica, non rimuoverla per evitare l'inserimento del bloccasterzo elettrico dopo lo smontaggio.
4. Individuare la sede della batteria e scollegarne il polo negativo.
5. Proseguire con lo smontaggio dei carter copri devio-luce e sottopancia con la strumentazione e la cura opportuna.
6. Rimuovere con cura il contenitore airbag (se presente) staccando il relativo cavetto.
7. Dopo aver sbloccato l'organo di blocco del volante (perno o dado) sfilare con cura lo stesso segnandone la posizione originale.
8. Scollegare le prese degli impianti: devio-luce, eventuali centraline e quelle del blocchetto chiave.
9. Rimuovere ulteriori carterini e parti in plastica fino a scoprire le staffe di supporto del piantone, quindi smontare bulloni e staffe di bloccaggio dello stesso e procedere smontando il perno di fissaggio alla scatola sterzo.
10. Scollegare il giunto cardanico facendo attenzione ad eventuali guaine di cavi elettrici e cablaggi in genere.
11. Durante l'operazione di estrazione del piantone fare attenzione ai supporti plastici presenti in generale.

12. Sganciare il cartellino giallo presente sul gruppo eps rigenerato e applicarlo sul reso da rendere: procedere quindi con l'operazione di montaggio.
13. Montare il gruppo eps rigenerato, riapplicando il bloccasterzo originale.
14. Se si tratta di un gruppo eps dotato di esp o dynamic control, evitare ogni rotazione del piantone rispetto alla configurazione di montaggio a ruote dritte così come fornito.
15. Collegare e serrare il giunto cardanico (a seconda del caso dall'interno o dall'esterno del veicolo) e dunque prestare attenzione al serraggio del perno di collegamento del cardano con l'asse della scatola guida.
16. Di seguito affrancare il gruppo eps ai suoi alloggi e serrare accuratamente i perni o dadi di fissaggio.
17. Rimontare con cura tutte le prese elettriche precedentemente scollegate (devio-luce, centraline, etc.).
18. Riposizionare carterini e parti plastiche inerenti.
19. Inserire il volante, fissarlo nella corretta posizione e rimontare il contenitore airbag.
20. Ricollegare il negativo della batteria ed effettuare un check-up degli azionamenti interessati.
21. Effettuare un giro di prova per verificare la centratura del volante, il bilanciamento della sterzata, l'eventuale presenza di rumorosità o altre anomalie.

Ogni altro eventuale chiarimento di natura tecnica potrà essere richiesto all'Azienda a mezzo fax o telefonicamente: personale qualificato provvederà a rispondere con competenza ai vari quesiti. In alcuni casi (es. sbilanciamento della sterzata) potrebbe essere necessario eseguire l'operazione di taratura del sensore posizione/coppia con opportuna strumentazione (examiner-diagnosi).



RIGENERAZIONE COMPLETA

- DISASSEMBLAGGIO** completo del gruppo;
- LAVAGGIO/VERNICIATURA** delle parti meccaniche;
- REVISIONE/SOSTITUZIONE** dei cuscinetti;
- VERIFICA** di eventuali eccentricità dell'albero interno;
- TARATURA** dei giochi dei giunti cardanici e degli accoppiamenti tra assi telescopici;
- TARATURA** dei giochi dell'accoppiamento vite senza fine/cremagliera del servomeccanismo;
- SOSTITUZIONE** del sensore posizione coppia;
- REVISIONE/SOSTITUZIONE** del motore di azionamento del servomeccanismo;
- REVISIONE/SOSTITUZIONE** del giunto elastico di calettamento del motore elettrico al servomeccanismo;
- REVISIONE/SOSTITUZIONE** della centralina elettronica;
- VERIFICA** dell'integrità di tutti i cablaggi e delle connessioni;
- INGRASSAGGIO** dei cuscinetti, dei giunti cardanici, del giunto elastico e del servomeccanismo;
- COLLAUDO E TARATURA** del servomeccanismo su banco di prova;
- CENTRATURA/ALLINEAMENTO** della sterzata e l'impedimento della rotazione con un opportuno sistema di bloccaggio meccanico;
- PROTEZIONE** delle parti filettate con specifiche protezioni di gomma.



GARANZIA La data di vendita ha valore quale inizio del periodo di garanzia che andrà a scadere inderogabilmente al termine del DODICESIMO MESE. Saranno riconosciute in garanzia le merci difettose nei particolari o nei processi di lavorazione a nostro insindacabile giudizio, franco nostro magazzino. La garanzia si concretizza nella sola sostituzione dei particolari da noi riconosciuti difettosi; non verranno riconosciute le eventuali spese di stacco e riattacco, i materiali di consumo e alcun danno conseguente. Al fine di evitare danneggiamenti durante l'installazione, Vi invitiamo in caso di necessità a contattare i nostri tecnici specializzati. In caso di difettosità dovuta a una errata installazione o a una manomissione (disassemblaggio, saldature, contaminazioni) non verrà accettata nessuna richiesta di garanzia. Le caratteristiche, le immagini, le prestazioni, i pesi e le misure indicate nei cataloghi si intendono del tutto indicativi ed approssimativi e possono variare senza preavviso. Per i materiali di non nostra fabbricazione, la garanzia viene concessa con tutte le limitazioni che ci dovessero essere imposte dai nostri fornitori.

ORDINI Gli ordini si intendono effettuati solo dopo nostra approvazione, che può essere tacita con l'evasione dell'ordine, od esplicita con conferma scritta. L'evasione degli ordini avviene sempre, a prescindere dalla quantità ordinata, in confezioni standard o multipli delle stesse; qualora il committente esiga confezioni in quantità differenti dallo standard, le stesse verranno approntate come richieste, ma senza sconti di quantità e salvo maggiori addebiti per costi di gestione. In caso di mancato ritiro delle merci ordinate, da parte nostra potremo pretendere l'esecuzione del contratto, oppure la sua risoluzione; in quest'ultimo caso, il committente dovrà corrispondere il 20% dell'importo delle forniture a titolo di penale.

PREZZI I prezzi si intendono per merce resa f.co ns. magazzino, escluso: imballaggio, affrancatura, trasporto, assicurazione, IVA ed ogni altra spesa di spedizione. I prezzi esposti a listino hanno la stessa validità del listino stesso, i prezzi relativi a nostre offerte verbali o scritte non possono avere validità superiore a trenta (30) giorni di calendario, salvo periodo inferiore da noi specificato in fase d'offerta. In ogni caso, i prezzi esposti o comunicati possono subire variazioni senza preavviso per improvvisa variazione del costo della materia prima, dei costi di produzione o del costo di manodopera per quanto riguarda i prodotti di nostra fabbricazione, per improvvisa variazione dei costi all'origine, o variazioni repentine del tasso di cambio della nostra moneta, o per quanto riguarda i prodotti da noi commercializzati e/o importati. Per questo è doveroso, da parte del cliente, richiedere, al momento dell'ordine, le quotazioni aggiornate.

CONFEZIONE ED IMBALLO Al costo e secondo le normative vigenti.

PAGAMENTI I pagamenti devono essere effettuati al nostro domicilio, entro i termini esposti sulla fattura. L'accettazione di cambiali o l'emissione di tratte non costituisce deroga né al luogo di pagamento, né ai termini esposti in fattura. Qualsiasi controversia non darà diritto alla sospensione o modificazione dei termini di pagamento convenuti. Interessi di mora - Il mancato rispetto dei termini di pagamento riportati in fattura viene considerato come condizione sufficiente per la messa in mora senza altro avviso, in conseguenza dal giorno successivo, alla scadenza pattuita, viene conteggiato il periodo di mora sino al momento della reale disponibilità da parte nostra della cifra dovuta; il tasso d'interesse che verrà applicato è nella misura dell'interesse bancario per prelevamento allo scoperto in atto al momento della mora. L'addebito degli interessi di mora non crea pregiudizio alla sospensione da parte nostra delle forniture sino alla definizione dei pagamenti sospesi. Nel caso si verificasse anche un solo insoluto, avvertiamo che, le consegne, degli ordini in corso anche a programma, verranno sospese ed i pagamenti futuri saranno in contrassegno.

RISERVATO DOMINIO I termini di consegna non sono tassativi e pertanto devono intendersi approssimativi; verificandosi casi fortuiti o di forza maggiore (compreso il caso di guerra, di mobilitazione o di requisizione), ci riserviamo il diritto di annullare in tutto od in parte le ordinazioni, senza che il committente possa richiedere il risarcimento di qualsiasi danno. Le avarie alle macchine, le interruzioni o limitazioni di energia elettrica o gas, i ritardi o l'insufficienza dei vagoni ferroviari e mezzi di trasporto, nonché qualsiasi fatto accidentale da cui esuli la nostra colpa, costituiscono casi fortuiti e di forza maggiore.

CONSEGNA I termini di consegna non sono tassativi e pertanto devono intendersi approssimativi; verificandosi casi fortuiti o di forza maggiore (compreso il caso di guerra, di mobilitazione o di requisizione), ci riserviamo il diritto di annullare in tutto od in parte le ordinazioni, senza che il committente possa richiedere il risarcimento di qualsiasi danno. Le avarie alle macchine, le interruzioni o limitazioni di energia elettrica o gas, i ritardi o l'insufficienza dei vagoni ferroviari e mezzi di trasporto, nonché qualsiasi fatto accidentale da cui esuli la nostra colpa, costituiscono casi fortuiti e di forza maggiore.

SPEDIZIONE La merce viaggia sempre a rischio e pericolo del committente, viene esclusa ogni nostra responsabilità, anche in caso di vendita franco destino a stazione arrivo. È dovere del committente verificare la condizione dei colli prima del ritiro, facendo le dovute riserve a chi di ragione in caso di differenze di peso o di constatate avarie. Eventuali assicurazioni sono a carico del committente e devono essere richieste esplicitamente nell'ordine. In caso di mancata indicazione da parte del committente delle modalità di spedizione, agiremo su nostra iniziativa al meglio nell'interesse del committente, ma senza alcuna responsabilità per quanto riguarda le tariffe e la via di trasporto prescelta.

RECLAMI Non si accettano reclami trascorsi otto (8) giorni dal ricevimento della merce. Per nessun motivo, sarà accettata di ritorno, senza nostra autorizzazione scritta, merce regolarmente ordinata. La merce usata da rendere (ove previsto) deve essere recapitata all'Azienda entro e non oltre quindici (15) giorni completa di cartellino identificativo. Il reso deve esser recuperabile: non arrugginito e completo come da nostra fornitura. In assenza di tali condizioni o in caso di mancato reso, sarà addebitato un importo commisurato al valore economico del reso. Per ogni controversia è competente il Foro di Fasano (BR)



IL CATALOGO

Ogni sezione è ordinata per marca e modello fatta eccezione per gli articoli che possono essere installati su più modelli: in questo caso per convenzione vengono riportati alla fine di ogni sezione, in modo da rendere semplice e rapida la consultazione del catalogo.

Il catalogo Block Stem si suddivide in cinque sezioni:



SERVOSTERZI ELETTRICI

Da pagina **6** a pagina **24**.



SCATOLE GUIDA ELETTROMECCANICHE

Da pagina **26** a pagina **29**.



POMPE ELETTRIDRAULICHE

Da pagina **30** a pagina **39**.



MOTORI ELETTRICI

A pagina **41**.



RICAMBI PER EPS

Da pagina **42** a pagina **44**.

ALFA ROMEO MITO CON ESP



 **ERARMCE**
CODICE INTERNO RIGENERATO

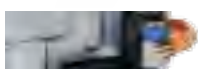

CARCASSA MOTORE IN LAMIERA

GUAINA SENSORE ARANCIONE

 **VERIFICARE** se il **SENSORE** è **INTAGRATO** o se ha **GUAINA ESTERNA**.

 **NON** far **RUOTARE** l'albero durante l'installazione.

ALFA ROMEO MITO SENZA ESP



 **ERARMSE**
CODICE INTERNO RIGENERATO



CARCASSA MOTORE IN LAMIERA

GUAINA SENSORE GIALLO

 **VERIFICARE** se il **SENSORE** è **INTAGRATO** o se ha **GUAINA ESTERNA**.

CITROËN C1



 Dal 2005 al 2013

 Dal 2005 al 2013

 Versione **BENZINA**

 Versione **DIESEL**

 **ERCC1B**
CODICE INTERNO RIGENERATO

 **ERCC1D**
CODICE INTERNO RIGENERATO

 La fornitura **COMPRENDE** anche la **CENTRALINA**.

 **VERIFICARE** se è **BENZINA** (etichetta centralina bianca e nera) o **DIESEL** (etichetta centralina bianca e verde).

FIAT 500 CON ESP



 Con **SENSORE** con **CAVO ESTERNO**

 Con **SENSORE INTEGRATO**

 Da Luglio 2007

 Da Luglio 2007

 **ERF5CE**
CODICE INTERNO RIGENERATO

 **ERF5CEINT**
CODICE INTERNO RIGENERATO



GUAINA SENSORE ARANCIONE

 Tasto **ASR** sulla **PLANCIA**.

 **VERIFICARE** se il **SENSORE** è **INTAGRATO** o se ha **GUAINA ESTERNA**.

 **NON** far **RUOTARE** l'albero durante l'installazione.

FIAT 500 SENZA ESP

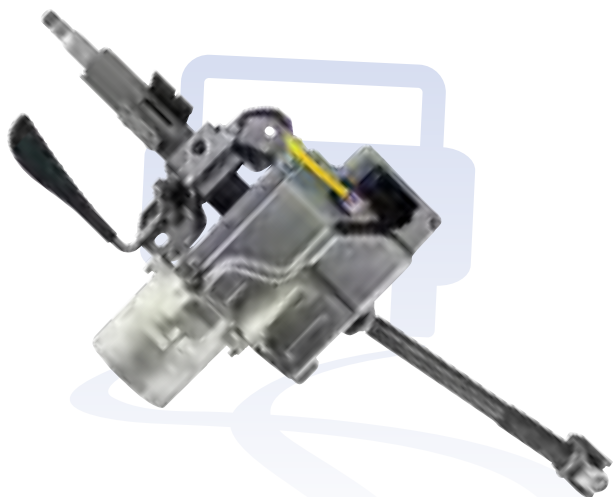

Con **SENSORE** con **CAVO ESTERNO**



Con **SENSORE INTEGRATO**



Da Luglio 2007



Da Luglio 2007



ERF5SE
CODICE INTERNO RIGENERATO



ERF5SEINT
CODICE INTERNO RIGENERATO



GUAINA SENSORE GIALLA



VERIFICARE se il **SENSORE** è **INTAGRATO** o se ha **GUAINA ESTERNA**.

FIAT 500 L CON ESP



Da Settembre 2012



ERF5LCE
CODICE INTERNO RIGENERATO



NON far **RUOTARE** l'albero durante l'installazione.

FIAT 500 L SENZA ESP



Da Settembre 2012



ERF5LSE
CODICE INTERNO RIGENERATO

FIAT 600

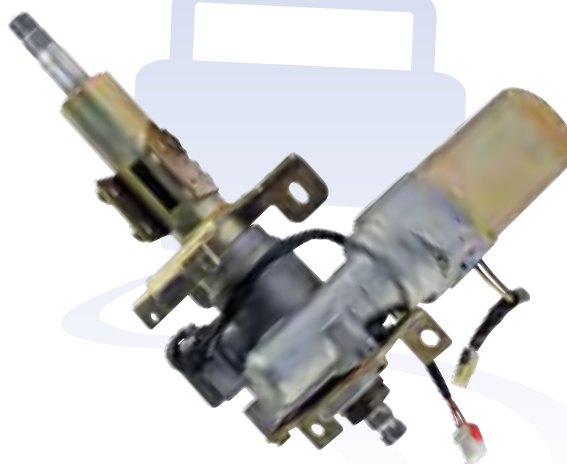

ERF6
CODICE INTERNO RIGENERATO



La **FORNITURA** non **COMPRENDE** la **CENTRALINA**.



Con **ANTIFURTO** sul piantone **RIGENERAZIONE** su originale.

FIAT BRAVO 2ª SERIE

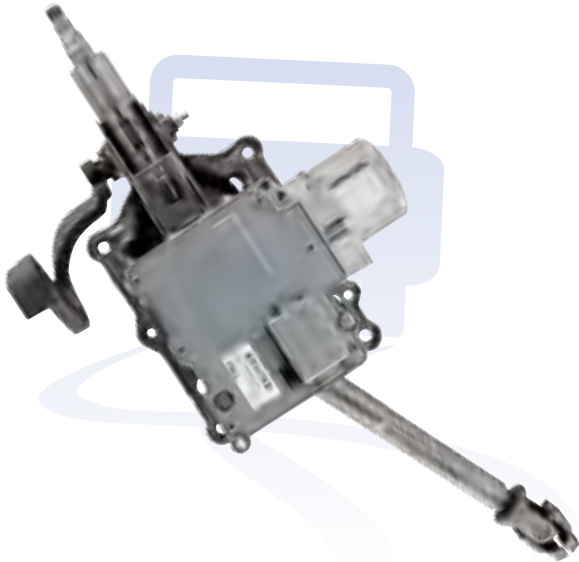

Da Febbraio 2007



ERFB
CODICE INTERNO RIGENERATO



CODICE ORIGINALE (FIAT N°)



COMUNICARE il **CODICE ORIGINALE** (FIAT N°) indicato sull'**ETICHETTA** presente sulla **CENTRALINA**.

FIAT GRANDE PUNTO (199)

CON ESP



Fino a Settembre 2008



Da Ottobre 2008



CODICE ORIGINALE
55703372, 55704059,
55704065



CODICE ORIGINALE
51826529



ERFGPCCE
CODICE INTERNO RIGENERATO



ERFGPCCE9
CODICE INTERNO RIGENERATO



GUAINA SENSORE
VIOLA O ARANCIONE



CODICE ORIGINALE
(DWG FIAT)



CARCASSA MOTORE
IN LEGA D'ALLUMINIO



Tasto **ASR** sulla **PLANCIA**.



NON far **RUOTARE** l'albero durante l'installazione.

FIAT GRANDE PUNTO (199)

SENZA ESP

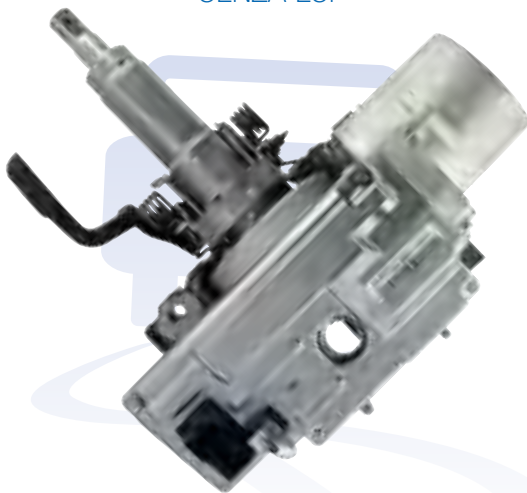

Fino a Settembre 2008



Da Ottobre 2008



CODICE ORIGINALE
55701321, 55704060,
55704061, 55704062



CODICE ORIGINALE
51826526



ERFGPCSE
CODICE INTERNO RIGENERATO



ERFGPCSE9
CODICE INTERNO RIGENERATO

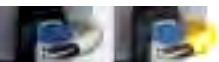

GUAINA SENSORE
BIANCA O GIALLA



CODICE ORIGINALE
(DWG FIAT)



CARCASSA MOTORE
IN LEGA D'ALLUMINIO

FIAT IDEA



CODICE ORIGINALE
...610



CODICE ORIGINALE
...279, ...280



ERFI610
CODICE INTERNO RIGENERATO



ERFI279
CODICE INTERNO RIGENERATO



CODICE ORIGINALE (FIAT N°)



COMUNICARE il **CODICE ORIGINALE** (FIAT N°) e **DATARIO** (DATE) indicati sull'**ETICHETTA** presente sulla **CENTRALINA**.

FIAT PANDA 2ª SERIE (169)

CON ESP



Mod. **100 HP**



Mod. **4x4**



Da Settembre
2003 al 2012



Da Settembre
2003 al 2012



Da Settembre
2003 al 2012



ERFP100ESP
CODICE INTERNO R.



ERFPESP
CODICE INTERNO R.



ERFPESP
CODICE INTERNO R.



GUAINA SENSORE AZZURRA



ETICHETTA "FIAT 169 ABS"



VERIFICARE se ha il tasto
"ASR" sulla plancia di comando.



VERIFICARE se sul bordo della
centralina c'è: "FIAT 169 ABS".



NON far **RUOTARE** l'albero durante l'installazione.

FIAT PANDA 2ª SERIE (169)

SENZA ESP



Mod. **100 HP**



Mod. **4x4**



Da Settembre
2003 al 2012



Da Settembre
2003 al 2012



Da Settembre
2003 al 2012



ERFP100H
CODICE INTERNO R.



ERFP4
CODICE INTERNO R.



ERFP
CODICE INTERNO R.



GUAINA SENSORE VERDE

FIAT PANDA 3ª SERIE (319)

CON ESP



Dal 2012



ERFPANNC
CODICE INTERNO RIGENERATO



NON far **RUOTARE** l'albero durante l'installazione.

FIAT PANDA 3ª SERIE (319)

SENZA ESP



Dal 2012



ERFPANNC
CODICE INTERNO RIGENERATO

FIAT PUNTO 2ª SERIE (188) CON REGOLAZIONE



 CODICE CENTRALINA 6971, 9232	 CODICE CENTRALINA 9236	 CODICE CENTRALINA 1075
 Fino ad Aprile 2003	 Fino ad Aprile 2003	 Da Maggio 2003
 ERFP8C71 CODICE INTERNO R.	 ERFP8C36 CODICE INTERNO R.	 ERFP8C75 CODICE INTERNO R.

 **6971** CODICE CENTRALINA

FIAT PUNTO 2ª SERIE (188) SENZA REGOLAZIONE





 CODICE CENTRALINA 6971, 9232	 CODICE CENTRALINA 9236	 CODICE CENTRALINA 1075
 Fino ad Aprile 2003	 Fino ad Aprile 2003	 Da Maggio 2003
 ERFP8S71 CODICE INTERNO R.	 ERFP8S36 CODICE INTERNO R.	 ERFP8S75 CODICE INTERNO R.

 **6971** CODICE CENTRALINA

FIAT PUNTO EVO CON ESP



 Da Ottobre 2009
 CODICE CENTRALINA 51860331
 ERFPECCE CODICE INTERNO RIGENERATO

 MORSETTIERA A DUE PRESE	 CODICE ORIGINALE (DWG FIAT)	 CARCASSA MOTORE IN LEGA D'ALLUMINIO
---	--	--

 Tasto **ASR** sulla **PLANCIA**.  Sensore **INTEGRATO**.

 **NON** far **RUOTARE** l'albero durante l'installazione.

FIAT PUNTO EVO SENZA ESP



 Da Ottobre 2009
 CODICE CENTRALINA 51860329
 ERFPECSE CODICE INTERNO RIGENERATO

 MORSETTIERA A DUE PRESE	 CODICE ORIGINALE (DWG FIAT)	 CARCASSA MOTORE IN LEGA D'ALLUMINIO
--	--	--

 Sensore **INTEGRATO**.

FIAT STILO

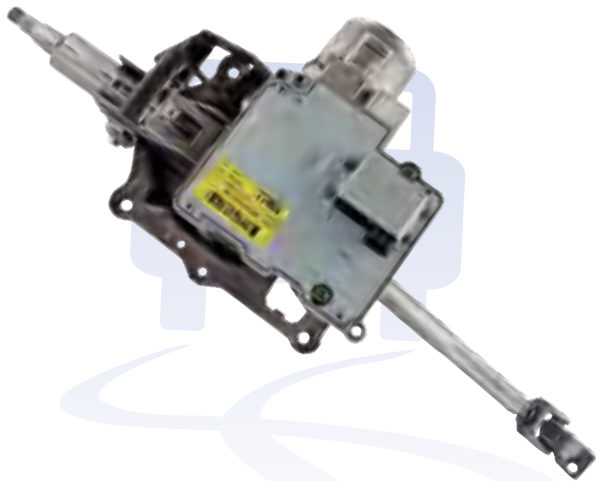

 CODICE ORIGINALE 46846724, 46846731	 CODICE ORIGINALE 46846857, 46846858	 CODICE ORIGINALE 51723100, 51723101
---	--	--

 Fino al 2003	 Dal 2003 al 2005	 Dal 2005
---	--	--

 ERFS731 CODICE INTERNO R.	 ERFS858 CODICE INTERNO R.	 ERFS101 CODICE INTERNO R.
--	---	---

 **CODICE ORIGINALE (FIAT N°)**

 **COMUNICARE** il **CODICE ORIGINALE** (FIAT N°) e **DATARIO** (DATE) indicati sull'**ETICHETTA** presente sulla **CENTRALINA**.

FORD FIESTA 6ª SERIE

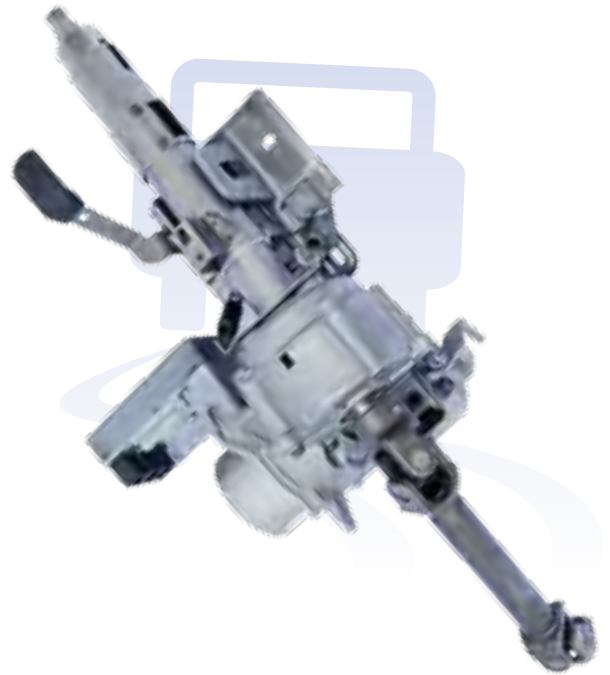

 Da Settembre 2008

 **ERFFVI**
CODICE INTERNO RIGENERATO

FORD KA 2ª SERIE CON ESP

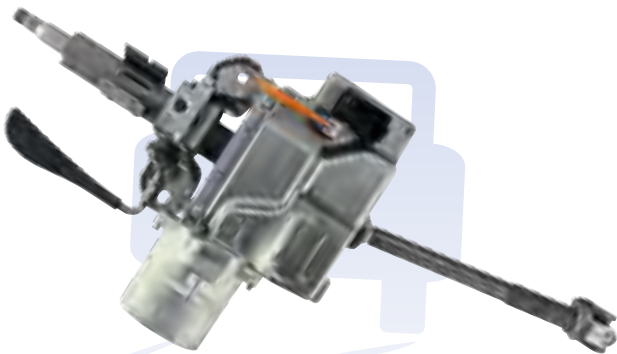

 Con SENSORE con CAVO ESTERNO	 Con SENSORE INTEGRATO
 Da Luglio 2007	 Da Luglio 2007
 ERFKCE CODICE INTERNO RIGENERATO	 ERFKCEINT CODICE INTERNO RIGENERATO

 **GUAINA SENSORE ARANCIONE**

 Tasto **ASR** sulla **PLANCIA**.

 **VERIFICARE** se il **SENSORE** è **INTAGRATO** o se ha **GUAINA ESTERNA**.

 **NON** far **RUOTARE** l'albero durante l'installazione.

FORD KA 2ª SERIE SENZA ESP

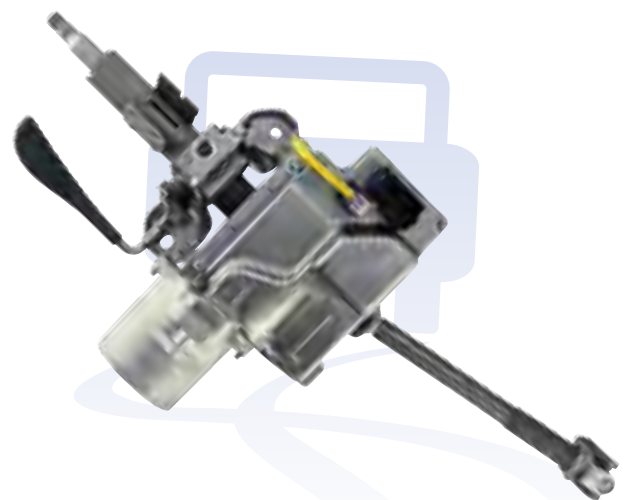

 Con SENSORE con CAVO ESTERNO	 Con SENSORE INTEGRATO
 Da Luglio 2007	 Da Luglio 2007
 ERFKSE CODICE INTERNO RIGENERATO	 ERFKSEINT CODICE INTERNO RIGENERATO

 **GUAINA SENSORE GIALLA**

 **VERIFICARE** se il **SENSORE** è **INTAGRATO** o se ha **GUAINA ESTERNA**.

HYUNDAI ACCENT



Dal 2005 al 2009



ERHA
CODICE INTERNO RIGENERATO



La fornitura **COMPRENDE** anche la **CENTRALINA**.



Con **ANTIFURTO** sul piantone **RIGENERAZIONE** su originale.

HYUNDAI I10



Dal 2007 al 2013



ERHI10
CODICE INTERNO RIGENERATO



La fornitura **COMPRENDE** anche la **CENTRALINA**.



Con **ANTIFURTO** sul piantone **RIGENERAZIONE** su originale.

HYUNDAI I20



Dal 2008



ERHI20
CODICE INTERNO RIGENERATO



La fornitura **COMPRENDE** anche la **CENTRALINA**.



Con **ANTIFURTO** sul piantone **RIGENERAZIONE** su originale.

HYUNDAI IX20



Dal 2010



ERHIX20
CODICE INTERNO RIGENERATO



La fornitura **COMPRENDE** anche la **CENTRALINA**.



Con **ANTIFURTO** sul piantone **RIGENERAZIONE** su originale.

HYUNDAI IX35



Da L. 2009



ERHIX35

CODICE INTERNO RIGENERATO



La fornitura **COMPRENDE** anche la **CENTRALINA**.



Con **ANTIFURTO** sul piantone **RIGENERAZIONE** su originale.

JEEP RENAGADE

CON ESP



Da Ottobre 2014



ERJRCE

CODICE INTERNO RIGENERATO



NON far **RUOTARE** l'albero durante l'installazione.

KIA PICANTO 2ª SERIE



Da Maggio 2011



ERKP

CODICE INTERNO RIGENERATO



La fornitura **COMPRENDE** anche la **CENTRALINA**.



Con **ANTIFURTO** sul piantone **RIGENERAZIONE** su originale.

KIA RIO 3ª SERIE



Da Settembre 2011



ERKR

CODICE INTERNO RIGENERATO



La fornitura **COMPRENDE** anche la **CENTRALINA**.



Con **ANTIFURTO** sul piantone **RIGENERAZIONE** su originale.

KIA SPORTAGE 3ª SERIE



 Da Settembre 2010

 **ERKS**
CODICE INTERNO RIGENERATO

 La fornitura **COMPRENDE** anche la **CENTRALINA**.

 Con **ANTIFURTO** sul piantone **RIGENERAZIONE** su originale.

LANCIA DELTA

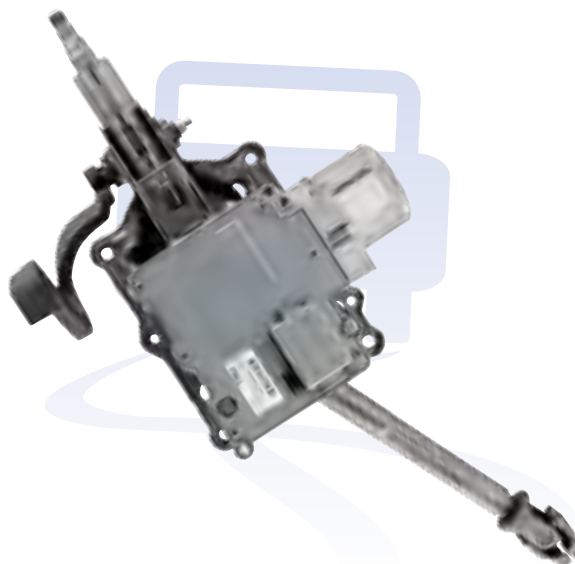

 Da Giugno 2008

 **ERLD**
CODICE INTERNO RIGENERATO

 **CODICE ORIGINALE (FIAT N°)**

 **COMUNICARE** il **CODICE ORIGINALE** (FIAT N°) indicato sull'**ETICHETTA** presente sulla **CENTRALINA**.

LANCIA MUSA



 **CODICE ORIGINALE**
...610

 **ERLM610**
CODICE INTERNO RIGENERATO

 **CODICE ORIGINALE**
...279, ...280

 **ERLM279**
CODICE INTERNO RIGENERATO

 **CODICE ORIGINA (FIAT N°)**

 **COMUNICARE** il **CODICE ORIGINALE** (FIAT N°) e **DATARIO** (DATE) indicati sull'**ETICHETTA** presente sulla **CENTRALINA**.

LANCIA YPSILON (843) CON ESP



 Dal 2003 al 2011

 **ERLYCE**
CODICE INTERNO RIGENERATO

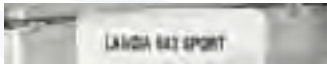
 **GUAINA SENSORE AZZURRA**  **ETICHETTA "LANCIA 843 SPORT"**

 **COMUNICARE** N°DISEGNO FIAT per ECU "...209" o "...210".

 **VERIFICARE** se sul bordo della centralina è riportato: "**LANCIA 843 SPORT**".

 **VERIFICARE** se ha il tasto **ASR** sulla plancia di comando.

 **NON** far **RUOTARE** l'albero durante l'installazione.

LANCIA YPSILON (843)

SENZA ESP



Dal 2003 al 2011



ERLYSE

CODICE INTERNO RIGENERATO



GUAINA SENSORE VERDE

LANCIA YPSILON (846)

CON ESP



Da Settembre 2011



ERLYPSNCE

CODICE INTERNO RIGENERATO



NON far **RUOTARE** l'albero durante l'installazione.

LANCIA YPSILON (846)

SENZA ESP



Da Settembre 2011



ERLYPSNCE

CODICE INTERNO RIGENERATO

MAZDA 6



ERMZ6

CODICE INTERNO RIGENERATO

NISSAN JUKE



Dal 2010 al 2014



ERNJ

CODICE INTERNO RIGENERATO

NISSAN MICRA K12



Versione **BENZINA**



Versione **DIESEL**



Dal 2002 a Giugno 2007



Dal 2002 a Giugno 2007



ERNMB

CODICE INTERNO RIGENERATO



ERNMD

CODICE INTERNO RIGENERATO



VERIFICARE se è **BENZINA** o **DIESEL**.

NISSAN MICRA K12 RESTYLING, NISSAN NOTE 1ª SERIE



Dal Luglio 2007 al 2010



ERNM3

CODICE INTERNO RIGENERATO

NISSAN MICRA K13, NISSAN NOTE 2ª SERIE



Dal 2010



ERNM4

CODICE INTERNO RIGENERATO



La **FORNITURA** non **COMPRENDE** la **CENTRALINA**.

NISSAN QASHQAI



Dal 2006 al 2014



CODICE CENTRALINA
48810BRGOA



ERNQQ
CODICE INTERNO RIGENERATO

NISSAN X-TRAIL 2ª SERIE

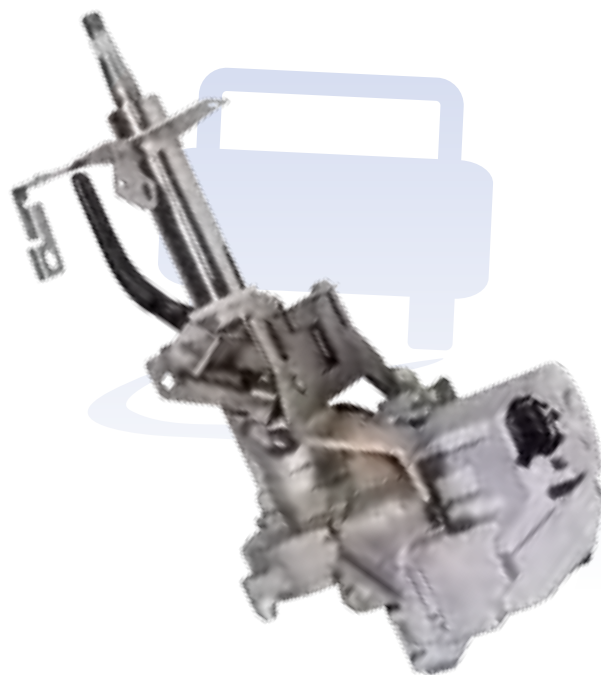

Da Luglio 2007



ERNXT
CODICE INTERNO RIGENERATO

OPEL ADAM CON ESP



Dal 2013



EROADCE
CODICE INTERNO RIGENERATO



NON far **RUOTARE** l'albero durante l'installazione.

OPEL ADAM SENZA ESP



Dal 2013



EROADSE
CODICE INTERNO RIGENERATO

OPEL AGILA A



 Dal 2000 al 2007

 **EROA**
CODICE INTERNO RIGENERATO

 La fornitura **COMPRENDE** anche la **CENTRALINA**.

 Con **ANTIFURTO** sul piantone **RIGENERAZIONE** su originale.

OPEL CORSA B

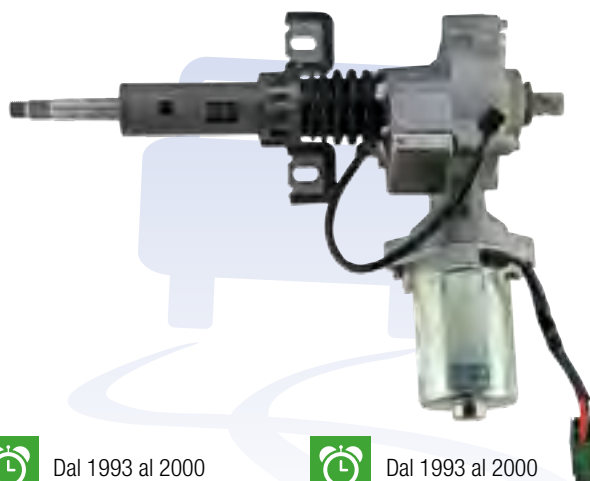

 Dal 1993 al 2000

 Cavo **LUNGO** +/- 75 cm

 **EROCBL**
CODICE INTERNO RIGENERATO

 Dal 1993 al 2000

 Cavo **CORTO** +/- 40 cm

 **EROCBC**
CODICE INTERNO RIGENERATO

 **CAVO LUNGO** +/- 75 cm
CAVO CORTO +/- 40 cm

 La **FORNITURA** non **COMPRENDE** la **CENTRALINA**.

 Con **ANTIFURTO** sul piantone **RIGENERAZIONE** su originale.

OPEL CORSA C CON REGOLAZIONE

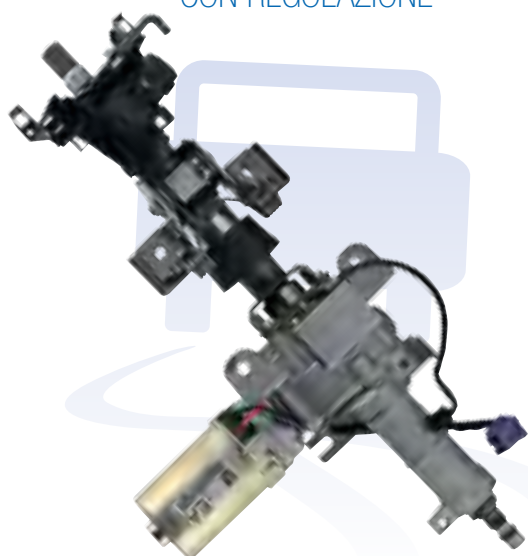

 Dal 2000 al 2006

 **EROCCCR**
CODICE INTERNO RIGENERATO

 La **FORNITURA** non **COMPRENDE** la **CENTRALINA**.

 Con **ANTIFURTO** sul piantone **RIGENERAZIONE** su originale.

OPEL CORSA C SENZA REGOLAZIONE

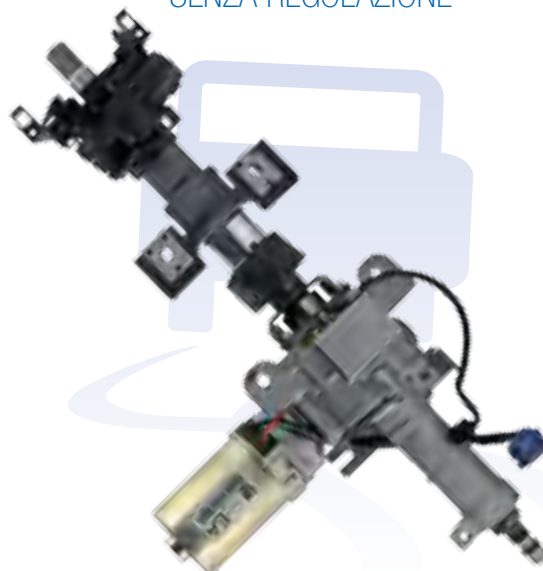

 Dal 2000 al 2006

 **EROCCSR**
CODICE INTERNO RIGENERATO

 La **FORNITURA** non **COMPRENDE** la **CENTRALINA**.

 Con **ANTIFURTO** sul piantone **RIGENERAZIONE** su originale.

OPEL CORSA D CON ESP



Dal 2006 al 2014



EROCDCCE
CODICE INTERNO RIGENERATO



CARCASSA MOTORE IN LAMIERA

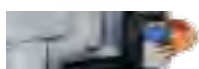

GUAINA SENSORE ARANCIONE



VERIFICARE se il SENSORE è INTAGRATO o se ha GUAINA ESTERNA.



NON far RUOTARE l'albero durante l'installazione.

OPEL CORSA D SENZA ESP



Dal 2006 al 2014



EROCDCSE
CODICE INTERNO RIGENERATO



CARCASSA MOTORE IN LAMIERA

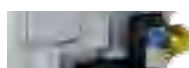

GUAINA SENSORE GIALLO



VERIFICARE se il SENSORE è INTAGRATO o se ha GUAINA ESTERNA.

OPEL MERIVA A

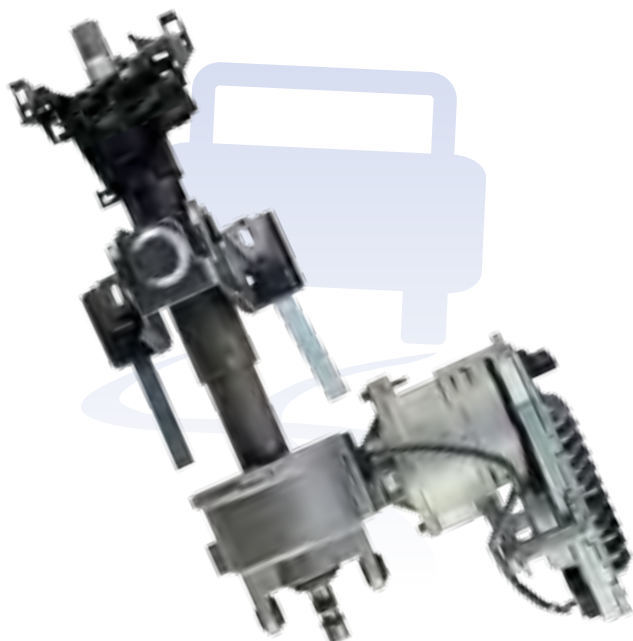

Dal 2003 al 2010



EROM
CODICE INTERNO RIGENERATO

OPEL MOKKA CON ESP



Dal 2012



EROMKCE
CODICE INTERNO RIGENERATO



NON far RUOTARE l'albero durante l'installazione.

OPEL MOKKA SENZA ESP



Dal 2012



EROMKSE
CODICE INTERNO RIGENERATO

PEUGEOT 107



Dal 2005 al 2014



Versione **BENZINA**



ERP107B
CODICE INTERNO RIGENERATO



Dal 2005 al 2014



Versione **DIESEL**



ERP107D
CODICE INTERNO RIGENERATO



La fornitura **COMPRENDE** anche la **CENTRALINA**.



VERIFICARE se è **BENZINA** (etichetta centralina bianca e nera) o **DIESEL** (etichetta centralina bianca e verde)

RENAULT CAPTUR



Da Maggio 2013



ERRCPT
CODICE INTERNO RIGENERATO

RENAULT CLIO 2ª SERIE



Da Giugno 2001 ad Agosto 2005



ERRC2
CODICE INTERNO RIGENERATO



La **FORNITURA** non **COMPRENDE** la **CENTRALINA**.



Con **ANTIFURTO** sul piantone **RIGENERAZIONE** su originale.

RENAULT CLIO 3ª SERIE



Da Ottobre 2005 a Settembre 2012



ERRC3

CODICE INTERNO RIGENERATO



CHIAVE di AVVIAMENTO MECCANICA.

RENAULT CLIO 4ª SERIE



Dal 2012



ERRC4

CODICE INTERNO RIGENERATO

RENAULT KOLEOS



Dal 2008



ERRKOL

CODICE INTERNO RIGENERATO

RENAULT MEGANE 2



Da Ottobre 2002 al 2010



ERRM2

CODICE INTERNO RIGENERATO



BOCCOLA DI ALLOGGIO
DEVOLUCI IN PLASTICA

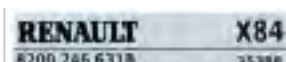

CODICE ORIGINALE RENAULT



PERNO di fissaggio bloccasterzo **SINISTRORSO**.



SMONTARE l'eps con **SCHEDA ELETTRICA** (chiave d'avviamento)
INSERITA.

RENAULT MODUS 1ª SERIE



Dal 2004 al 2006



ERRMD1

CODICE INTERNO RIGENERATO

RENAULT MODUS 2ª SERIE



Dal 2007



ERRMD2

CODICE INTERNO RIGENERATO

RENAULT SCENIC 2ª SERIE CON ESP



Da Giugno 2003 a Maggio 2009



ERRMS2

CODICE INTERNO RIGENERATO



**BOCCOLA DI ALLOGGIO
DEVIOLUCI IN ALLUMINIO**

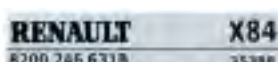

RENAULT X84
8200 246 6318 35388

CODICE ORIGINALE RENAULT



PERNO di fissaggio bloccasterzo **SINISTRORSO**.



SMONTARE l'eps con **SCHEDA ELETTRICA** (chiave d'avviamento) **INSERITA**.

RENAULT SCENIC 2ª SERIE SENZA ESP



Da Giugno 2003 a Maggio 2009



ERRMS1

CODICE INTERNO RIGENERATO



**BOCCOLA DI ALLOGGIO
DEVIOLUCI IN PLASTICA**

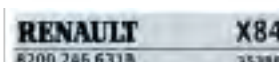

RENAULT X84
8200 246 6318 35388

CODICE ORIGINALE RENAULT



PERNO di fissaggio bloccasterzo **SINISTRORSO**.



SMONTARE l'eps con **SCHEDA ELETTRICA** (chiave d'avviamento) **INSERITA**.

RENAULT TWINGO MK1



 Fino a Giugno 2007

 **ERRT**
CODICE INTERNO RIGENERATO

 La **FORNITURA** non **COMPRENDE** la **CENTRALINA**.

 Con **ANTIFURTO** sul piantone **RIGENERAZIONE** su originale.

TOYOTA AURIS 2ª SERIE



 Da Novembre 2012

 **ERTAU2**
CODICE INTERNO RIGENERATO

TOYOTA AYGO

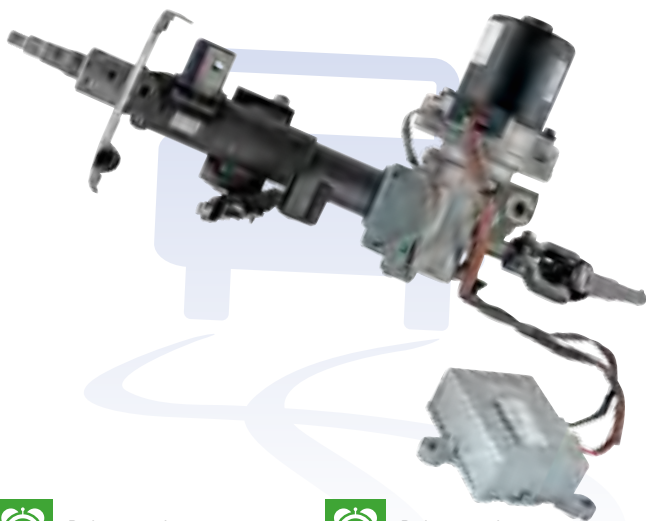

 Dal 2005 al 2013

 Dal 2005 al 2013

 Versione **BENZINA**

 Versione **DIESEL**

 **ERTAYB**
CODICE INTERNO RIGENERATO

 **ERTAYD**
CODICE INTERNO RIGENERATO

 La fornitura **COMPRENDE** anche la **CENTRALINA**.

 **VERIFICARE** se è **BENZINA** (etichetta centralina bianca e nera) o **DIESEL** (etichetta centralina bianca e verde)

TOYOTA RAV 4 3ª SERIE



 Dal 2005 al 2012

 **ERTR4**
CODICE INTERNO RIGENERATO

 La **FORNITURA** non **COMPRENDE** la **CENTRALINA**.

TOYOTA YARIS 1ª SERIE



Fino a Dicembre 2005



ERTY1

CODICE INTERNO RIGENERATO

SPINOTTO SENSORE COPPIA A 6/8 PIN



La **FORNITURA** non **COMPRENDE** la **CENTRALINA**.



Con **ANTIFURTO** sul piantone **RIGENERAZIONE** su originale.

TOYOTA YARIS 2ª SERIE



Da Gennaio 2006 ad Ottobre 2011



ERTY2

CODICE INTERNO RIGENERATO



La **FORNITURA** non **COMPRENDE** la **CENTRALINA**.



Con **ANTIFURTO** sul piantone **RIGENERAZIONE** su originale.

VOLKSWAGEN LUPO 3L



ERVL3L

CODICE INTERNO RIGENERATO



La **FORNITURA** non **COMPRENDE** la **CENTRALINA**.



Con **ANTIFURTO** sul piantone **RIGENERAZIONE** su originale.



Se vuoi proteggere la tua auto affidati a dei professionisti.

Bloccare la direzionalità del mezzo è sicuramente la maniera più efficace per impedire il furto. Per questo uno staff di tecnici qualificati ha creato **Block Shaft**, il più robusto e sofisticato **antifurto meccanico per auto**.

Praticamente invisibile, perchè integrato saldamente al piantone dello sterzo, rende inattaccabile la tua automobile senza modificarne l'estetica. Facilissimo da utilizzare grazie alla nuova serratura Netoma con chiave induplicabile, brevettata e prodotta da Block Shaft srl e certificata dall'istituto Giordano. La collaborazione con i maggiori Istituti di certificazione, le convenzioni con le migliori compagnie assicurative, il servizio di assistenza post vendita in tutta Europa e 15 anni di esperienza, fanno di Block Shaft il Numero 1 degli antifurto meccanici.

FACILISSIMO DA UTILIZZARE
IMPEDISCE LA DIREZIONALITÀ DEL MEZZO
SERRATURA CON CHIAVE INDUPLICABILE
COMPONENTI IN ACCIAIO AD ALTA RESISTENZA
SCONTO FINO AL 75% SU FURTO INCENDIO
GARANZIA E ASSISTENZA IN TUTTA EUROPA
OLTRE 15 ANNI DI ESPERIENZA

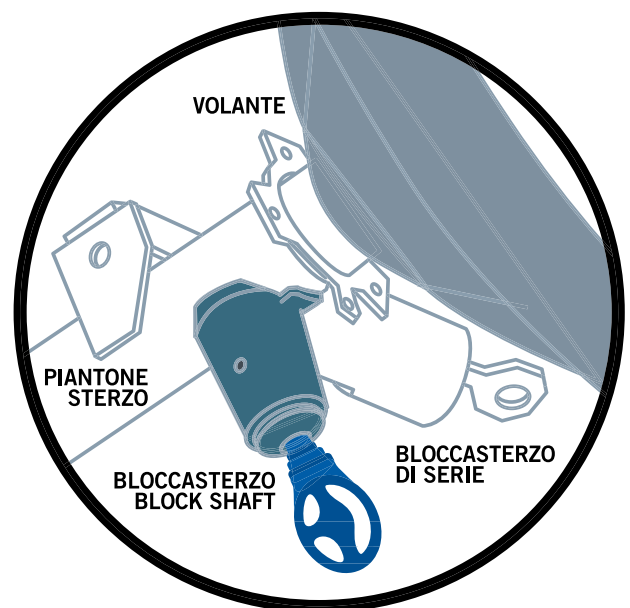

✓ INVISIBILE

✓ EFFICACE

✓ SICURO

✓ GARANTITO

**BLOCK
SHAFT**
ANTIFURTO MECCANICO PER AUTO



**BLOCK
SHAFT** 

70043 Monopoli (BA) - Italy - S.S. 16 Uscita Zona Ind.
Tel. +39 080 930.92.11 - Fax +39 080 930.92.22

www.blockshaft.it

AUDI, VOLKSWAGEN



1ª generazione



Dal 2003 a Febbraio 2005



Audi A3,
Volkswagen Touran



SGEN001

CODICE INTERNO NUOVO

SGER001

CODICE INTERNO RIGENERATO



La FORNITURA non COMPRENDE le TESTINE.

AUDI, SEAT, SKODA, VOLKSWAGEN



2ª generazione



Da Marzo 2005 al 2008



Audi A3, Audi TT, Seat Altea, Seat Leon, Seat Toledo, Skoda Octavia, Volkswagen Caddy, Volkswagen Eos, Volkswagen Golf 5, Volkswagen Golf 5 Plus, Volkswagen Golf 5 Variant, Volkswagen Jetta, Volkswagen Passat, Volkswagen Passat Variant



SGER002

CODICE INTERNO RIGENERATO



La FORNITURA non COMPRENDE le TESTINE.

AUDI, SEAT, SKODA, VOLKSWAGEN



3ª generazione



Dal 2009 al 2012



Audi A3, Audi TT, Seat Altea, Seat Leon, Seat Toledo, Skoda Octavia, Volkswagen Caddy, Volkswagen Eos, Volkswagen Golf 6, Volkswagen Golf 6 Plus, Volkswagen Golf 6 Variant, Volkswagen Jetta, Volkswagen Passat, Volkswagen Passat Variant, Volkswagen Touran



SGER003

CODICE INTERNO RIGENERATO



VERIFICARE se l'attacco è a 3 o 4 FORI.



La FORNITURA non COMPRENDE le TESTINE.

AUDI, SEAT, SKODA, VOLKSWAGEN



4ª generazione



Dal 2012



Audi A3, Audi TT, Seat Altea, Seat Leon, Seat Toledo, Skoda Octavia, Volkswagen Caddy, Volkswagen Eos, Volkswagen Golf 7, Volkswagen Golf 7 Plus, Volkswagen Golf 7 Variant, Volkswagen Jetta, Volkswagen Passat, Volkswagen Passat Variant



SGEN004

CODICE INTERNO NUOVO



La FORNITURA non COMPRENDE le TESTINE.

BMW MINI



Modello **R56**



Dal 2008



CODICE ORIGINALE

32106778557, 32106783250, 32106856876,
32106793007



SGERBMIN

CODICE INTERNO RIGENERATO



La **FORNITURA** non **COMPRENDE** le **TESTINE**.

CITROËN, PEUGEOT



Diametro cerchi **14"**



Citroën C2 Mk1 Dal 2002 A Giugno 2009,
Citroën C3 Mk1 Dal 2002 A Giugno 2009,
Peugeot 1007



SGER014

CODICE INTERNO RIGENERATO



La **FORNITURA** non **COMPRENDE** le **TESTINE**.



La **FORNITURA** non **COMPRENDE** la **CENTRALINA**.

CITROËN, PEUGEOT



Diametro cerchi **15"**



Citroën C2 Mk1 Dal 2002 A Giugno 2009,
Citroën C3 Mk1 Dal 2002 A Giugno 2009,
Peugeot 1007



SGER015

CODICE INTERNO RIGENERATO



La **FORNITURA** non **COMPRENDE** le **TESTINE**.



La **FORNITURA** non **COMPRENDE** la **CENTRALINA**.

CITROËN PICASSO



Dal 2010



Versione **BENZINA**



SGERCP10B

CODICE INTERNO RIGENERATO



La **FORNITURA** non **COMPRENDE** le **TESTINE**.

FIAT SEDICI



SGERF16

CODICE INTERNO RIGENERATO



La FORNITURA non COMPRENDE le TESTINE.



La FORNITURA non COMPRENDE la CENTRALINA.

MERCEDES



Classe A 2ª serie (W169) da Luglio 2004 al 2011,
Classe B 1ª serie (W245) dal 2005 al 2011



SGERM CAB

CODICE INTERNO RIGENERATO



La FORNITURA non COMPRENDE le TESTINE.

MERCEDES SMART FOR TWO



Fino al 2014



Modello 450/451



SGERMSM42

CODICE INTERNO RIGENERATO



La FORNITURA non COMPRENDE le TESTINE.



La FORNITURA non COMPRENDE la CENTRALINA.

MERCEDES SMART FOR FOUR, MITZUBISHI COLT



Smart Four Four,
Mitsubishi Colt



SGERMSM44

CODICE INTERNO RIGENERATO



La FORNITURA non COMPRENDE le TESTINE.



La FORNITURA non COMPRENDE la CENTRALINA.

PEUGEOT 207



 **INNESTO** presa alimentazione **FORO UNICO**

 **INNESTO** presa alim. **FORO DOPPIO**

 **SGERP27S**
CODICE INTERNO RIGENERATO

 **SGERP27D**
CODICE INTERNO RIGENERATO



INNESTO PRESA ALIMENTAZIONE FORO UNICO



INNESTO PRESA ALIMENTAZIONE FORO DOPPIO

 La **FORNITURA** non **COMPRENDE** le **TESTINE**.

PEUGEOT 207 GRUPPO CENTRALINA MOTORE



 **INNESTO** presa alimentazione **FORO UNICO** e **PIGNONE** motore a **3 DENTI**

 **INNESTO** presa alimentazione **FORO DOPPIO** e **PIGNONE** motore a **3 DENTI**

 **GCMRP27S3**
CODICE INTERNO RIGENERATO

 **GCMRP27D3**
CODICE INTERNO RIGENERATO

 **INNESTO** presa alimentazione **FORO UNICO** e **PIGNONE** motore a **4 DENTI**

 **INNESTO** presa alimentazione **FORO DOPPIO** e **PIGNONE** motore a **4 DENTI**

 **GCMRP27S4**
CODICE INTERNO RIGENERATO

 **GCMRP27D4**
CODICE INTERNO RIGENERATO



INNESTO PRESA ALIMENTAZIONE FORO UNICO



INNESTO PRESA ALIMENTAZIONE FORO DOPPIO

PIGNONE MOTORE A 3 DENTI

PIGNONE MOTORE A 4 DENTI

PEUGEOT 208



 Dal 2012

 **SGERP208**
CODICE INTERNO RIGENERATO

 La **FORNITURA** non **COMPRENDE** le **TESTINE**.

SUZUKI SX4



 **RETYLING**

 Dal Marzo 2006 a Settembre 2009

 **SGERSX4**
CODICE INTERNO RIGENERATO

 La **FORNITURA** non **COMPRENDE** le **TESTINE**.

 La **FORNITURA** non **COMPRENDE** la **CENTRALINA**.

AUDI A2



Cilindrata 1.2 TDI



Cilindrata 1.4, 1.4 TDI, 1.4 TDI I, 1.6 FSI DIESEL



PELNAA2

CODICE INTERNO NUOVO

PELRAA2

CODICE INTERNO RIGENERATO



PELNAA2S

CODICE INTERNO NUOVO

PELRAA2S

CODICE INTERNO RIGENERATO

CITROËN C4



Modello TRW



PELNCC4

CODICE INTERNO N.



PELNCC4B

CODICE INTERNO N.



PELNCC4C

CODICE INTERNO N.



PELNCC4E

CODICE INTERNO N.



PELNCC4F

CODICE INTERNO N.



COMUNICARE il CODICE ORIGINALE.

CITROËN C4



Modello HPI



PELN06

CODICE INTERNO NUOVO

PELR06

CODICE INTERNO RIGENERATO

CITROËN C5



PELNCC5

CODICE INTERNO NUOVO

PELRCC5

CODICE INTERNO RIGENERATO

CITROËN C15, BERLINGO



 Citroën C15, Citroën Berlingo

 **MELNXCC15**
CODICE INTERNO NUOVO

CITROËN SAXO 1ª SERIE



 **MELNXCS1**
CODICE INTERNO NUOVO

CITROËN SAXO 2ª SERIE



 **MELNXCS2**
CODICE INTERNO NUOVO

DACIA LOGAN



 Modello **HPI**

 **PELNXL**
CODICE INTERNO NUOVO
PELRXL
CODICE INTERNO RIGENERATO

FIAT CROMA 1ª SERIE



Dal 2005 ad Ottobre 2007



PELNXFC1

CODICE INTERNO NUOVO

PELRXFC1

CODICE INTERNO RIGENERATO

FIAT CROMA 2ª SERIE



Da Novembre 2007



PELNXFC

CODICE INTERNO NUOVO

PELRXFC

CODICE INTERNO RIGENERATO

FORD FIESTA 4ª SERIE



MELNxFF4

CODICE INTERNO NUOVO

FORD FIESTA 5ª SERIE, FUSION



Ford Fiesta 1.6 Tdci, Ford Fusion 1.6 Tdci



PELN02

CODICE INTERNO NUOVO

PELR02

CODICE INTERNO RIGENERATO

FORD GALAXY, S-MAX



 Ford Galaxy 2.0 TDI dal 2006 a Marzo 2010, S-Max 2.0 TDCI

PELN03

CODICE INTERNO NUOVO

PELR03

CODICE INTERNO RIGENERATO

FORD FOCUS II, FOCUS C-MAX, C-MAX, KUGA



Morsettiere a 2 PRESE



Focus II 1.4, 1.6, 1.6 TDCI, 1.6 TI, 1.8, 1.8 TDCI, 2.0, 2.0 TDCI, Focus C-Max dal 2003 al 2007 1.6, 1.6 TDCI, 1.6 TI, 1.8 TDCI, 2.0, 2.0 TDCI, Focus C-Max dal 2007 al 2010 1.6 TDCI, 1.8, 1.8 TDCI, 2.0, 2.0 TDCI, Kuga 2.0 TDCI



Morsettiere a 3 PRESE



PELNxFFCM

CODICE INTERNO NUOVO

PELRxFFCM

CODICE INTERNO RIGENERATO



PELNxFFCM2

CODICE INTERNO NUOVO

PELRxFFCM2

CODICE INTERNO RIGENERATO



MORSETTIERA A 2 PRESE



MORSETTIERA A 3 PRESE

FORD FOCUS II, KUGA



 Focus II 2.5, Kuga 2.5

PELNxFFC2

CODICE INTERNO NUOVO

PELRxFFC2

CODICE INTERNO RIGENERATO



MORSETTIERA A 2 PRESE



MORSETTIERA A 3 PRESE

MERCEDES CLASSE A 1ª SERIE (W168)



Dal 1997 ad Agosto 2004



PELNXMCA

CODICE INTERNO NUOVO

PELRXMCA

CODICE INTERNO RIGENERATO

MINI BMW



Dal 2001 al 2007



PELNXBMIN
CODICE INTERNO NUOVO

OPEL ASTRA G, ZAFIRA A



Modello **TRW2**



Opel Astra G dal 1998 al 2004, Zafira A dal 1999 al 2005



PELN07
CODICE INTERNO NUOVO

PELR07
CODICE INTERNO RIGENERATO



TUBO alta pressione **MODIFICATO** disponibile a magazzino.



È POSSIBILE INSTALLARLA in sostituzione del modello **TRW1** e **DELPHI** modificando il **TUBO** dell'alta pressione dell'**OLIO**.

OPEL ASTRA G, ZAFIRA A



Modello **TRW2**



Opel Astra G dal 1998 al 2004, Zafira A dal 1999 al 2005



PELN07KIT
CODICE INTERNO NUOVO

PELR07KIT
CODICE INTERNO RIGENERATO



È POSSIBILE installarlo in **SOSTITUZIONE** dei modelli **DELPHI** e **TRW**.

OPEL ASTRA H, ZAFIRA B



Modello **TRW**



Opel Astra H dal 2005 al 2011, Zafira B dal 2005 AL 2011



PELN08
CODICE INTERNO NUOVO

PELR08
CODICE INTERNO RIGENERATO

OPEL ASTRA H, ZAFIRA B



Modello **ZF**



Opel Astra H dal 2005 al 2011, Zafira B dal 2005 AL 2011



PELN09

CODICE INTERNO NUOVO

PELR09

CODICE INTERNO RIGENERATO

OPEL MERIVA B



Modello **TRW**



Dal 2010



PELNOMB

CODICE INTERNO NUOVO

PELROMB

CODICE INTERNO RIGENERATO

OPEL SIGNUM, VECTRA C 1ª SERIE



Opel Signum, Opel Vectra C 1ª serie



PELN0VC1

CODICE INTERNO NUOVO

PELR0VC1

CODICE INTERNO RIGENERATO

OPEL SIGNUM, VECTRA C 2ª SERIE, SAAB 9.3



Opel Signum, Opel Vectra C 2ª serie, Saab 9.3



PELN0VC

CODICE INTERNO NUOVO

PELR0VC

CODICE INTERNO RIGENERATO

OPEL SIGNUM, VECTRA C 2ª SERIE, SAAB 9.3



Opel Signum, Opel Vectra C 2ª serie, Saab 9.3



PELNXPVCKIT
CODICE INTERNO NUOVO
PELRXPVCKIT
CODICE INTERNO RIGENERATO

PEUGEOT 106



MELNXP106
CODICE INTERNO NUOVO

PEUGEOT 205



MELNXP205
CODICE INTERNO NUOVO

PEUGEOT 206



MELNXP206
CODICE INTERNO NUOVO

PEUGEOT 307



 **PELNX307**
CODICE INTERNO NUOVO
PELRX307
CODICE INTERNO RIGENERATO

PEUGEOT 308



 **PELNX308**  **PELNX308A**  **PELNX308B**
CODICE INTERNO N. CODICE INTERNO N. CODICE INTERNO N.

 **COMUNICARE il CODICE ORIGINALE.**

PEUGEOT 407



 **PELNX407**
CODICE INTERNO NUOVO
PELRXP407
CODICE INTERNO RIGENERATO

RENAULT CLIO 1ª SERIE



 **MELNXRC1**
CODICE INTERNO NUOVO

RENAULT CLIO 2ª SERIE, KANGOO



Da Giugno 2001 ad Agosto 2005



Renault Clio 2ª serie, Renault Kangoo



MELNXRC2K
CODICE INTERNO NUOVO

RENAULT KANGOO



Da Giugno 2005



PELNXRK
CODICE INTERNO NUOVO
PELXRK
CODICE INTERNO RIGENERATO

SEAT CORDOBA, IBIZA SKODA FABIA, ROOMSTER VOLKSWAGEN FOX, LUPO, POLO



Modello **TRW**



Seat Cordoba, Seat Ibiza, Skoda Fabia, Skoda Roomster, Volkswagen Fox, Volkswagen Lupo, Volkswagen Polo



PELN01
CODICE INTERNO NUOVO
PELR01
CODICE INTERNO RIGENERATO

SEAT CORDOBA, IBIZA SKODA FABIA, ROOMSTER VOLKSWAGEN FOX, LUPO, POLO



Modello **TRW**



Seat Cordoba, Seat Ibiza, Skoda Fabia, Skoda Roomster, Volkswagen Fox, Volkswagen Lupo, Volkswagen Polo



PELN01KIT
CODICE INTERNO NUOVO



È POSSIBILE installarlo in **SOSTITUZIONE** del modello **KOYO**.

**PEUGEOT 807, EXPERT, PARTNER
CITROËN C8 E JUMPY, FIAT SCUDO E
ULISSE, LANCIA PHEDRA**



Citroën C8, Citroën Jumpy, Fiat Scudo, Fiat Ulisse, Fiat Lancia Phedra, Peugeot 807, Peugeot Expert, Peugeot Partner



PELN04

CODICE INTERNO NUOVO

PELR04

CODICE INTERNO RIGENERATO



**INNESTO PRESA ALIMENTAZIONE
FORO UNICO**

**PEUGEOT 807, EXPERT, PARTNER
CITROËN C8 E JUMPY, FIAT SCUDO E
ULISSE, LANCIA PHEDRA**



Citroën C8, Citroën Jumpy, Fiat Scudo, Fiat Ulisse, Fiat Lancia Phedra, Peugeot 807, Peugeot Expert, Peugeot Partner



PELN04NEW

CODICE INTERNO NUOVO

PELR04NEW

CODICE INTERNO RIGENERATO



**INNESTO PRESA ALIMENTAZIONE
FORO DOPPIO**

VOLVO C30, S40, V50



PELN05

CODICE INTERNO NUOVO

PELR05

CODICE INTERNO RIGENERATO

L'evoluzione nella protezione dei veicoli commerciali

+ **PERFORMANTE**

+ **SICURO**

+ **VERSATILE**

Gatelock Van è un **sistema di protezione degli accessi al vano di carico per veicoli commerciali**.

Si applica sui portelloni del vano di carico rendendolo **inattaccabile** dai più frequenti tentativi di effrazione. Grazie alle sue geometrie costruttive ed al robusto corpo in acciaio, Gatelock Van resiste a qualsiasi utensile da scasso, al taglio e alle forature da trapano. Gatelock Van consente di effettuare le operazioni di carico e scarico merci in modo veloce, comodo e sicuro perchè rimane ancorato al furgone chiudendosi automaticamente alla chiusura dei portelloni ed è disponibile in diversi modelli e dimensioni.

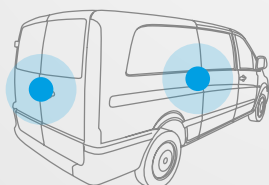

- **FLESSIBILITÀ**
disponibile per ogni tipo di veicolo commerciale
- **DESIGN ANTIEFFRAZIONE**
non afferrabile con utensili da scasso
- **CORPO IN ACCIAIO**
con trattamento di nickelatura superficiale
- **CILINDRO DI SICUREZZA**
certificato UE EN1303
- **APPLICAZIONE ESTERNA**
deterrente contro potenziali attacchi
- **MASSIMA SICUREZZA**
chiusura automatica del sistema
- **APERTURA INTERNA**
rispetto delle norme di sicurezza
- **QUALITÀ CERTIFICATA**
certificato da SOLD SECURE UK
- **MADE IN ITALY**
totalmente realizzato in Italia

GATELOCK
NUOVA SERIE **VAN**



70043 Monopoli (BA) - Italy - S.S. 16 Uscita Zona Ind.
Tel. +39 080 930.92.11 - Fax +39 080 930.92.22

www.blockshaft.it / www.gatelockvan.com

MOTORE ELETTRICO RIGENERATO



Citroën Saxo 1ª serie, Citroën Saxo 2ª serie, Ford Fiesta fino al 2001, Nissan Almera 1ª serie, Peugeot 106 1ª serie, Peugeot 106 2ª serie, Renault Clio 1ª serie, Renault Clio 2ª serie, Renault Kangoo 2ª serie



MELN01
CODICE INTERNO NUOVO

MOTORE ELETTRICO BMW MINI



Dal 2001 al 2007



CR50, R52, R53, R56 solo 2007



MELNXBMIN
CODICE INTERNO NUOVO



La **FORNITURA** potrebbe prevedere la restituzione del **RESO**.



CORPO MOTORIDUTTORE FIAT PUNTO 2ª SERIE (188)



 **CMRFP188**
CODICE INTERNO RIGENERATO

CORPO MOTORIDUTTORE FIAT PUNTO 2ª SERIE (188) SENZA REGOLAZIONE

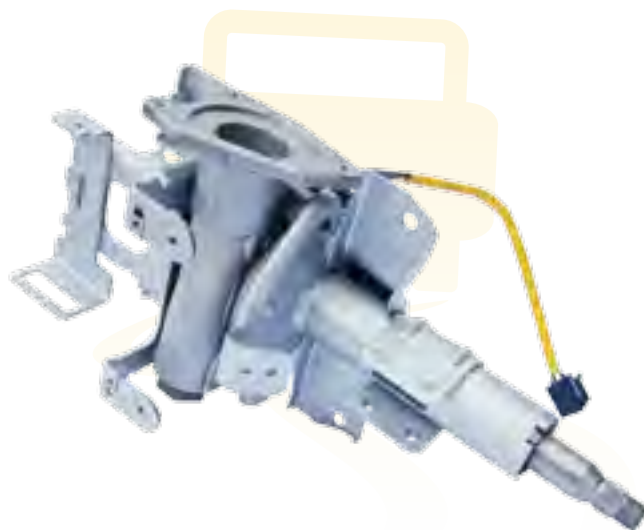

 **CMRFP188S**
CODICE INTERNO RIGENERATO

CORPO MOTORIDUTTORE FIAT PUNTO 2ª SERIE (188) CON REGOLAZIONE

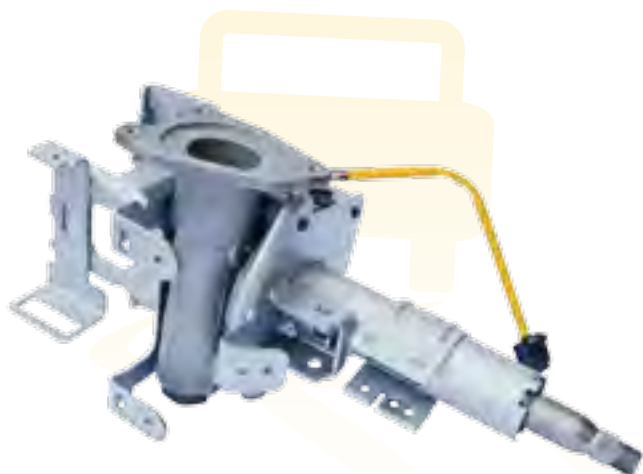

 **CMRFP188R**
CODICE INTERNO RIGENERATO

CORPO MOTORIDUTTORE FIAT PANDA 2ª SERIE (169)



 **CMRFP**
CODICE INTERNO RIGENERATO

CORPO MOTORIDUTTORE LANCIA YPSILON (843)



 **CMRLY**
CODICE INTERNO RIGENERATO

CORPO MOTORIDUTTORE OPEL MERIVA A



 **CMROM**
CODICE INTERNO RIGENERATO

MOTORINO FIAT PUNTO 2ª SERIE (188) CON RELAY



 **MEP188**
CODICE INTERNO RIGENERATO

SENSORI DI COPPIA

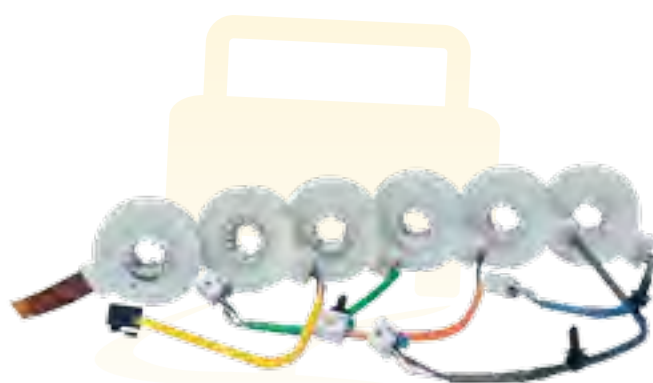

 **SENS**
CODICE INTERNO NUOVO

CENTRALINA EPS FIAT 600



 **CENRX600**
CODICE INTERNO RIGENERATO

CENTRALINA EPS OPEL CORSA C



 **CENRXOCC**
CODICE INTERNO RIGENERATO

CENTRALINA EPS CITROËN C1, PEUGEOT 107 E TOYOTA AYGO



 Citroën C1, Peugeot 107 e Toyota Aygo

 Versione **BENZINA**

 Versione **DIESEL**

 **COMUNICARE** marca modello e **ALIMENTAZIONE**.

CENTRALINA EPS CITROËN C3



 **CENRXCC3**
CODICE INTERNO RIGENERATO



BLOCK STEM SRL

S.S. 16 Uscita Z.I. Monopoli · 70043 Monopoli [BA] [Italy] · Tel. +39 080 914 2000 · Fax +39 080 914 2020

C.F. - P.IVA **02060270747** R.I. BR · www.blockstem.it · info@blockstem.it

www.epsrigenerati.com



BLOCK[®] STEM

VALVOLE EGR | CORPI FARFALLATI



CATALOGO 2014

Distribuito da



BLOCK[®] STEM

VALVOLE EGR

Il ricircolo dei gas di scarico consiste nell'immettere una piccola parte dei gas combusti (5-15 %) nuovamente nel collettore di aspirazione: questo passaggio viene effettuato attraverso una apposita elettrovalvola conosciuta con il nome di EGR (Exhaust Gas Recirculation). Essa viene comandata dalla centralina del motore tramite un segnale PWM (Pulse Width Modulation: modulazione di larghezza di impulso) consentendo la regolazione della quantità di gas che devono essere messi in ricircolo. Assieme ai gas di scarico però, il circuito preleva anche i gas provenienti dal carter dovuti al filtraggio attraverso le fasce elastiche. Il ricircolo dei gas combusti, gas

inerti e che non partecipano alla combustione, diminuendo la quantità di miscela utile al fine della combustione e della potenza erogata, serve fondamentalmente ad abbassare le temperature massime del ciclo, riducendo, in tal modo, le emissioni di ossidi di azoto (NOx).

Non è raro che la valvola EGR sia soggetta a malfunzionamenti, ciò a causa dello stretto contatto che ha con i gas di scarico, compromettendo ovviamente il rendimento del motore: si tratta infatti di gas contenenti particelle di olio e carburante incombusto che tendono a depositarsi all'interno del corpo valvola fino a provocarne l'intasamento con il conseguente

danneggiamento dell'attuatore della valvola stessa.



CORPI FARFALLATI

Il corpo farfallato è una parte meccanica del motore posta nell'impianto d'alimentazione che si occupa di regolare il flusso d'aria da immettere nella camera di combustione. Il corpo farfallato è composto essenzialmente da un condotto principale cilindrico o ovale che mette in comunicazione l'interno del gruppo termico (cilindro, testata, pistone, camera di combustione) con l'esterno.

Lungo il percorso di questo condotto si trova una valvola a farfalla, che ha la funzione di regolare il flusso d'aria all'interno del condotto stesso.

La valvola è gestita in modo diretto o indiretto dal comando dell'acceleratore: accelerare significa, in pratica, fare in modo che il comando apra la valvola e provochi un maggiore afflusso d'aria. L'aria all'interno del corpo farfallato viene aspirata grazie alla depressione creata, all'interno del cilindro, dal moto discendente del pistone.

Alcuni corpi farfallati, per garantire la certezza di una quantità minima d'aria

in qualsiasi condizione ed eventualità, sono provvisti di un secondo condotto che by-passa la valvola e che funge da condotto per il regime del minimo che a sua volta viene regolato da un motorino elettrico detto anche in gergo meccanico "motorino del minimo" che regola quanto basta il flusso della carburazione tenendo il motore ad un regime costante ai bassi regimi.



BLOCK[®] STEM

ORDINI

Gli ordini si intendono effettuati solo dopo nostra approvazione, che può essere tacita con l'evasione dell'ordine, od esplicita con conferma scritta. L'evasione degli ordini avviene sempre, a prescindere dalla quantità ordinata, in confezioni standard o multipli delle stesse; qualora il committente esiga confezioni in quantità differenti dallo standard, le stesse verranno approntate come richieste, ma senza sconti di quantità e salvo maggiori addebiti per costi di gestione. In caso di mancato ritiro delle merci ordinate, da parte nostra potremo pretendere l'esecuzione del contratto, oppure la sua risoluzione; in quest'ultimo caso, il committente dovrà corrispondere il 20% dell'importo delle forniture a titolo di penale.

PREZZI

I prezzi si intendono per merce resa f.co ns. magazzino, escluso: imballaggio, affrancatura, trasporto, assicurazione, IVA ed ogni altra spesa di spedizione. I prezzi esposti a listino hanno la stessa validità del listino stesso, i prezzi relativi a nostre offerte verbali o scritte non possono avere validità superiore a trenta (30) giorni di calendario, salvo periodo inferiore da noi specificato in fase d'offerta. In ogni caso, i prezzi esposti o comunicati possono subire variazioni senza preavviso per improvvisa variazione del costo della materia prima, dei costi di produzione o del costo di manodopera per quanto riguarda i prodotti di nostra fabbricazione, per improvvisa variazione dei costi all'origine, o variazioni repentine del tasso di cambio della nostra moneta, o per quanto riguarda i prodotti da noi commercializzati e/o importati. Per questo è doveroso, da parte del cliente, richiedere, al momento dell'ordine, le quotazioni aggiornate.

CONFEZIONI ED IMBALLO

Al costo e secondo le normative vigenti.

PAGAMENTI

I pagamenti devono essere effettuati al nostro domicilio, entro i termini esposti sulla fattura. L'accettazione di cambiali o l'emissione di tratte non costituisce deroga né al luogo di pagamento, né ai termini esposti in fattura. Qualsiasi controversia non darà diritto alla sospensione o modificazione dei termini di pagamento convenuti. Interessi di mora - Il mancato rispetto dei termini di pagamento riportati in fattura viene considerato come condizione sufficiente per la messa in mora senza altro avviso, in conseguenza dal giorno successivo, alla scadenza pattuita, viene conteggiato il periodo di mora sino al momento della reale disponibilità da parte nostra della cifra dovuta; il tasso d'interesse che verrà applicato è nella misura dell'interesse bancario per prelevamento allo scoperto in atto al momento della mora. L'addebito degli interessi di mora non crea pregiudizio alla sospensione da parte nostra delle forniture sino alla definizione dei pagamenti sospesi. Nel caso si verificasse anche un solo insoluto, avvertiamo che, le consegne, degli ordini in corso anche a programma, verranno sospese ed i pagamenti futuri saranno in contrassegno.

RISERVATO DOMINIO

Tutti i nostri materiali sono venduti con patto di riservato dominio. Pertanto sino a che non saranno integralmente pagate le fatture, i materiali si intendono di nostra proprietà, ai sensi dell'art. 1523 c.c.

CONSEGNA

I termini di consegna non sono tassativi e pertanto devono intendersi approssimativi; verificandosi casi fortuiti o di forza maggiore (compreso il caso di guerra, di mobilitazione o di requisizione), ci riserviamo il diritto di annullare in tutto od in parte le ordinazioni, senza che il committente possa richiedere il risarcimento di qualsiasi danno. Le avarie alle macchine, le interruzioni o limitazioni di energia elettrica o gas, i ritardi o l'insufficienza dei vagoni ferroviari e mezzi di trasporto, nonché qualsiasi fatto accidentale da cui esuli la nostra colpa, costituiscono casi fortuiti e di forza maggiore.

SPEDIZIONE

La merce viaggia sempre a rischio e pericolo del committente, viene esclusa ogni nostra responsabilità, anche in caso di vendita franco destino a stazione arrivo. È dovere del committente verificare la condizione dei colli prima del ritiro, facendo le dovute riserve a chi di ragione in caso di differenze di peso o di constatate avarie. Eventuali assicurazioni sono a carico del committente e devono essere richieste esplicitamente nell'ordine. In caso di mancata indicazione da parte del committente delle modalità di spedizione, agiremo su nostra iniziativa al meglio nell'interesse del committente, ma senza alcuna responsabilità per quanto riguarda le tariffe e la via di trasporto prescelta.

RECLAMI E RESI

Non si accettano reclami trascorsi otto (8) giorni dal ricevimento della merce. Per nessun motivo, sarà accettata di ritorno, senza nostra autorizzazione scritta, merce regolarmente ordinata. La merce usata da rendere (ove previsto) deve essere recapitata all'Azienda entro e non oltre quindici (15) giorni completa di cartellino identificativo. Il reso deve esser recuperabile: non arrugginito e completo come da nostra fornitura. In assenza di tali condizioni o in caso di mancato reso, sarà addebitato un importo commisurato al valore economico del reso. Per ogni controversia è competente il Foro di Fasano (BR)

BLOCK[®] STEM

GARANZIA

La data di vendita ha valore quale inizio del periodo di garanzia che andrà a scadere inderogabilmente al termine del dodicesimo mese. Verrà riconosciuta la garanzia solo sulla merce che risulterà difettosa nei particolari o nei processi di lavorazione a nostro insindacabile giudizio, franco nostro magazzino. La garanzia si concretizza nella sola sostituzione dei particolari da noi riconosciuti difettosi; non verranno riconosciute spese di montaggio, i materiali di consumo, né alcun danno conseguente. In caso di difettosità dovuta ad una errata installazione o a una manomissione, non verrà accettata nessuna richiesta di garanzia. Inoltre, non sarà riconosciuta alcuna garanzia su valvole egr e corpi farfallati che risultino inquinati da depositi carboniosi e altri residui della combustione in quanto questo indica che la riparazione si è limitata unicamente alla sola sostituzione del componente, senza aver prima rimosso le cause del guasto.

SUGGERIMENTI E NOTE D'INSTALLAZIONE

1. Prima della sostituzione, verificare sempre la pulizia di tutto il condotto dalla valvola egr al collettore di scarico. Se questo fosse intasato oltremisura rispetto al chilometraggio del veicolo significa che sono presenti elevate infiltrazioni di lubrificante in aspirazione. In questo caso, si consiglia di utilizzare appositi additivi nel carburante per ripristinare o migliorare la compressione nei cilindri limitando al minimo l'imbrattamento del collettore e allungando di conseguenza la vita della valvola egr e/o del corpo farfallato.
2. Si consiglia la pulizia dei contatti elettrici sul connettore a bordo vettura.
3. Accertarsi che la valvola egr e il corpo farfallato siano pilotati dalla centralina di gestione motore in modo corretto (test attuatore con strumentazione diagnostica).
4. Eventuale inizializzazione sistema Egr con strumentazione diagnostica.
5. Il cattivo funzionamento del DPF (filtro anti particolato a caldo) può generare contropressioni che possono generare la rottura meccanica della valvola egr.

Infine è importante tener presente che anche lo stile di guida del cliente può accelerare la contaminazione della valvola egr e/o corpo farfallato: chi compie sempre e soltanto percorsi brevi e a bassi regimi senza mai "tirare" il motore favorisce l'intasamento di tutto il sistema egr.

Fiat, Lancia

46477364



 **VEGRRE01**

Fiat

46778198 - 46535796



 **VEGRRE02**

Fiat, Lancia, Opel, Suzu

55201144 - 55184651



 **VEGRRE03**

Gruppo

60816439 - 17123451



 **VEGRRE04**

Gruppo

46823850 - 55194735



 **VEGRRE05**

Fiat

9659694780



 **VEGRRE06**

Nissan, Renault

7518013 - 14710BN701



 **VEGRRE07**

Opel (A)

09158987 - 55351260



 **VEGRRE08**

Opel

5851604 - R1090061



 **VEGRRE09**

Peugeot

1618R5



 **VEGRRE10**

Citroën

8C1Q9D475BA - 6C1Q9D475



 **VEGRRE11**

Smart

0004721V006



 **VEGRRE12**

Audi, Skoda, VW

038131501G



 **VEGRRE13**

Gruppo Volkswagen

6756564 - 036131503M



 **VEGRRE14**

Fiat

9681825280 - 9656612380



 **VEGRRE15**

Toyota

27620-27080



 **VEGRRE16**

Opel (C)

90570476 - 5851020



 **VEGRRE17**

Renault

8200270177 - 8200452876



 **VEGRRE18**

Opel, Saab

9196675 - 93176989



 **VEGRRE19**

Ford

1313847 - 3M5Q9D475AC



 **VEGRRE20**

Mercedes

6401400760 - 6401401160



 **VEGRRE21**

BMW

11717804382 - 7791480



 **VEGRRE22**

Daewoo

96612545



 **VEGRRE23**

BMW

11717785452



 **VEGRRE24**

Seat, Volkswagen

038131501AR - 038131501M



 **VEGRRE25**

Opel

9128573 - 849087



 **VEGRRE26**

Opel

849124 - 849156



 **VEGRRE27**

Audi, Seat, VW

038131501AF - 038131501S



 **VEGRRE28**

Audi

03G131501B - 03G131501Q



 **VEGRRE29**

Audi, Volkswagen

03813501AD - 038131501AD



 **VEGRRE30**

Audi, Ford, Seat, VW

6M219D475AA - 1212966



 **VEGRRE31**

Citroën, Ford, Peugeot, Toyota

1618N8 - SU00100702



 **VEGRRE32**

Ford, Peugeot

1363591 - 2S6Q9D475BB



 **VEGRRE33**

Mercedes

A6110900754



 **VEGRRE34**

Mercedes

6680900454 - 6680900154



 **VEGRRE35**

Fiat Opel

55186214 - 55194734



 **VEGRRE36**

Citroën, Ford, Peugeot, Toyota

1618N8 - SU00100702



 **VEGRRE37**

Ford, Peugeot

1363591 - 2S6Q9D475BB



 **VEGRRE38**

Citroën, Ford, Mazda, Peugeot,

2S6Q9D475AA - 1148077



 **VEGRRE39**

Mercedes

6461400760 - 6461400860



 **VEGRRE40**

Peugeot

215969659 - 1628WR



 **VEGRRE41**

Ford, Volvo

123196G - 25375741



 **VEGRRE42**

Gruppo Volkswagen

030131503F



 **VEGRRE43**

Isuzu, Opel

8973550420



 **VEGRRE44**

Ford

1333574 - 2S7Q9D475BC



 **VEGRRE45**

Alfa, Fiat, Opel, Suzuki

55204249 - 55215032



 **VEGRRE46**

Opel (A)

5851029 - 90570477



 **VEGRRE47**

Opel (A)

55556720 - 5851057



 **VEGRRE48**

Gruppo Volkswagen

038131501E - 045131501C



VEGRRE49

Ford

XS40-9424-AG - 027AA



VEGRRE50

Opel

9128573 - 849087



VEGRRE51

Renault

7701068109



VEGRRE52

BMW, Opel

11712244900



VEGRRE53

Renault

8200088888 - 8200169634



VEGRRE54

Renault

8200229190 - 8200231630



VEGRRE55

Renault

8200293950 - 8200360201



VEGRRE56

Renault

8200374875



VEGRRE57

Citroën

53418200 - 98T274



VEGRRE58

Jaguar

6X71-9F479-BB - 61230172



VEGRRE59

Renault

8200507299



VEGRRE60

Toyota

25620-33030 - 135000-8120



VEGRRE61

Mercedes

A6401401260



VEGRRE62

Mitsubishi, Saab

1582A037 - K5T70081



VEGRRE63

Citroën, Peugeot

9633602180 - 1628JZ - 1628SV



VEGRRE64

Seat, Skoda, Volkswagen

03G131501A - 03G131501M



VEGRRE65

Mercedes

00005320C2



VEGRRE66

Lancia

46460132



VEGRRE67

Hyundai, Kia

2841027250



VEGRRE68

Jaguar

6570-9D475-AC



VEGRRE69

Toyota

25620-26090



VEGRRE70

Gruppo Volkswagen

03G131502 - 03G131502B



VEGRRE71

Honda

18011PWA050



VEGRRE72

Volkswagen

03D131503A



VEGRRE73

Nissan

14710AD20A



VEGRRE74

Audi, Seat, Skoda, VW

045129637A - 045131501F/K



VEGRRE75

Mazda

K5T70871



VEGRRE76

Smart

A6391400560 - A6601400360



VEGRRE77

Gruppo Volkswagen

036131503R - 036131503T



VEGRRE78

Citroën, Jaguar, Land Rover, Peugeot

4R8Q-9D475-B - 1618N7 - JDE3315



VEGRRE79

Nissan

14710-MA70A - 150100-0011



VEGRRE80

Chevrolet, Daewoo

96325535 - 96291093



 **VEGRRE81**

Gruppo Fiat, Saab

55209609 - 71749240



 **VEGRRE82**

Audi, Ford, Seat, VW

028131501A



 **VEGRRE83**

Daewoo, Opel

5851002



 **VEGRRE84**

Opel

8973586130 - HU135000-7130



 **VEGRRE85**

Fiat

55182483



 **VEGRRE86**

Daewoo, Fiat, Ssangyong

A0021401360



 **VEGRRE87**

Mercedes

A0011409660



 **VEGRRE88**

Mercedes

A0021400260



 **VEGRRE89**

Renault

7700869607



 **VEGRRE90**

Maybach, Mercedes

A1121400060



 **VEGRRE91**

Ford

96FF9D475BB



 **VEGRRE92**

Audi

046131503A



 **VEGRRE93**

Audi, Skoda, VW

059131503



 **VEGRRE94**

Audi, Seat, VW

028131501M



 **VEGRRE95**

Rover

WAV100220



 **VEGRRE96**

Mercedes

A0021401760



 **VEGRRE97**

Renault

7700100230



 **VEGRRE98**

Ford

954F9D475DA



 **VEGRRE99**

Land Rover

ERR4047



 **VEGRRE100**

Opel

5851580



 **VEGRRE101**

Ford, Mazda, Volvo

1SG9D475AG



 **VEGRRE102**

Ford

2S7Q9D475AC



 **VEGRRE103**

Alfa Romeo, Fiat

46477397



 **VEGRRE104**

Opel

5851586



 **VEGRRE105**

Seat, Skoda, VW

03D131503B



 **VEGRRE106**

Fiat, Peugeot

9628355780 - 1628JF



 **VEGRRE107**

Audi, Seat, Skoda, VW

06A131501F



 **VEGRRE108**

Seat, Skoda, VW

038131501AG



 **VEGRRE109**

Citroën, Fiat, Peugeot

1628PB - 96381115



 **VEGRRE110**

Fiat

96381112 - 96381112805



 **VEGRRE111**

Citroën, Peugeot

1628PA / 96381113



 **VEGRRE112**

Citroën, Peugeot

1628PC - 96381114



VEGRRE113

Peugeot

96366756 - 1628JY



VEGRRE114

Mercedes

21402660



VEGRRE115

Audi, Seat, Skoda, VW

038131501T



VEGRRE116

Mercedes

A6400901470



VEGRRE117

Fiat, Peugeot

16287T - 9619452580



VEGRRE118

Peugeot

16289Z - 9630820780



VEGRRE119

Fiat, Peugeot

1628CF - 9630651780



VEGRRE120

Fiat, Peugeot

9657912780 - 1618Q0



VEGRRE121

Fiat, Peugeot

1628WV - 9635651080



VEGRRE122

Citroën, Jaguar, Land Rover, Peugeot

4R8Q9D475-AC - JDE3314/1316149



VEGRRE123

Ford, Volvo

3M5Q9D475CA - 1353152



VEGRRE124

Audi, Seat, VW

06A131501G



VEGRRE126

Renault

7700867485



VEGRRE127

Gruppo Volkswagen

216035358



VEGRRE128



VEGRRE125

Hyundai, Kia

284104X900



VEGRRE129

Alfa, Fiat, Lancia, Opel

5851065



VEGRRE130

Hyundai, Kia

284104A510



VEGRRE131

Audi, Volkswagen

045131501D



VEGRRE132

Volkswagen

074129463A



VEGRRE133

Volkswagen

070128070B



VEGRRE134

Volkswagen

070128070F



VEGRRE135

Mercedes

6110900354



VEGRRE136

Opel

55566052



VEGRRE137

Opel

97353973



VEGRRE138

Opel

851151 - 97184925



VEGRRE139

Iveco

504099669



VEGRRE140

Citroën, Peugeot

9638035080



VEGRRE141

Nissan, Renault

8200797706



VEGRRE142

Opel

96408500 / 5851025



VEGRRE143

Renault

8200796571



VEGRRE144

Audi, Volkswagen

06F131503B



 **VEGRRE145**

Audi, Volkswagen

03C131503B



 **VEGRRE146**

Renault

7701058850



 **VEGRRE147**

Fiat, Citroën, Peugeot

555090 - 162642



 **VEGRRE148**

Hyundai, Kia

284104A010



 **VEGRRE149**

Citroën, Peugeot

1628VT



 **VEGRRE150**

Fiat

71753846



 **VEGRRE151**

Fiat, Opel

71739811



 **VEGRRE152**

Fiat

55206931



 **VEGRRE153**

Fiat

55206932



 **VEGRRE154**

Fiat

9638374180



 **VEGRRE155**

Fiat, Opel

9656911780



 **VEGRRE156**

Fiat, Citroën, Peugeot

1628RH - 9637517280



 **VEGRRE157**

Fiat

71747145



 **VEGRRE158**

Fiat

71753849



 **VEGRRE159**

Gruppo Volkswagen

059131501D



 **VEGRRE160**

Hyundai, Kia

284104X900



 **VEGRRE161**

Alfa, Fiat, Lancia, Opel

5851065



 **VEGRRE162**

Hyundai, Kia

284104A510



 **VEGRRE163**

Audi, Volkswagen

045131501D



 **VEGRRE164**

Mazda

RF3F20300A



 **VEGRRE165**

Renault

7700101088



 **VEGRRE166**

Volkswagen

72257402



 **VEGRRE167**



 **VEGRRE168**

Hyundai, Kia

284102A100



 **VEGRRE169**

Mercedes

0021402660 - 0021400060



 **VEGRRE170**

Hyundai, Kia

284104A410



 **VEGRRE171**

Hyundai, Kia

2841027410



 **VEGRRE172**

Fiat

504150396



 **VEGRRE173**

Opel

8973766632 - K5T70380



 **VEGRRE174**

Mercedes

A6281400060 - 090413214Q4



 **VEGRRE175**

BMW, Toyota

2562033010



 **VEGRRE176**

Nissan, Renault

14710-DB002



VEGRRE177

Mercedes

A6421401760



VEGRRE178

Citroën, Peugeot

9638374480 - 1628XP



VEGRRE179

Mercedes

A6110900554



VEGRRE180

Opel, Renault

8200222772-A2C5309175



VEGRRE181

Land Rover

17270013R



VEGRRE182

Land Rover

17370032L



VEGRRE183

Chevrolet, Daewoo

962535548



VEGRRE184

Chrysler

72829005 - 49002021F



VEGRRE185

Fiat

YC1Q-9475BF



VEGRRE186

Mazda

79376K6266



VEGRRE187

Ssangyong

6651400660 - 6651400560



VEGRRE188

Audi, Volkswagen

07Z131501A



VEGRRE189

Daewoo, Chevrolet

96408500 - 25182127



VEGRRE190

Hyundai, Kia

284102A120



VEGRRE191

Hyundai, Kia

2841027001



VEGRRE192

Hyundai, Kia

284104X510



 **VEGRRE193**

Volkswagen, Audi

038131501AB



 **VEGRRE194**

Daewoo

96291087 - 17092164



 **VEGRRE195**

Mercedes

0011409560 - 0011404860



 **VEGRRE196**

Mercedes

0011406560 - 0011409160



 **VEGRRE197**

Opel

17096243 - 5851009



 **VEGRRE198**

Opel, Subaru

9198821 - 05851608 - 17094107



 **VEGRRE199**

BMW, Mercedes

0011408260 - 0011409460



 **VEGRRE200**

Ford

6563542 - 7091568 - 91FF9D475BB



 **VEGRRE201**

Mercedes

11407660



 **VEGRRE202**

Mercedes

6461400860 - 7353D



 **VEGRRE203**

Mercedes

6120980417



 **VEGRRE204**

Mercedes

6110900254



 **VEGRRE205**

Mercedes

6461401760 - 6461402360



 **VEGRRE206**

Mercedes

6461400960 - 6461401960



 **VEGRRE207**

Fiat

504351131



 **VEGRRE208**

Ford, Land Rover

7H2Q-9D475-CF
7H2Q-9D475-CC - LR018323



 **VEGRRE209**

Ford, Land Rover

7H2Q-9D475-DB
7H2Q-9D475-DE - LR018324



 **VEGRRE210**

Gruppo Volkswagen

076131501A



 **VEGRRE211**

Daewoo

96335930 - 17089050 - 17201251



 **VEGRRE212**

Mercedes

6421401760



 **VEGRRE213**

Gruppo Volkswagen

074129499B



 **VEGRRE214**

Volvo

6842404 - 6842725



 **VEGRRE215**

Mercedes

A0011407060 - A0011408960



 **VEGRRE216**

Audi, Seat, VW

037131501D



 **VEGRRE217**

Audi, Seat, Skoda, VW

55206932



 **VEGRRE218**

Audi, Seat, VW

06A131501E - 06A131501N



 **VEGRRE219**

Alfa Romeo, Fiat, Lancia

17094174 - 46477364



 **VEGRRE220**

Hyundai, Kia

284102F000



 **VEGRRE221**

Audi, Vad, VW

06A131501R



 **VEGRRE222**

Kia

284104A100



 **VEGRRE223**

Iveco

504388655



 **VEGRRE224**

Iveco

5801385941



 **VEGRRE225**

Fiat, Chrysler

4900202023F



 **VEGRRE226**

Volkswagen

03G131501E



 **VEGRRE227**

Skoda

03L131512CF



 **VEGRRE228**

Volvo

30774445 - 70056104



 **VEGRRE229**

Nissan

147105M001



 **VEGRRE230**

Toyota

25620-27090 - 135000-8110



 **VEGRRE231**

Mercedes

A6110980417



 **VEGRRE232**

Hyundai

28410-4A470



 **VEGRRE233**

Mercedes

A6401401960



 **VEGRRE234**

Toyota

13H101H24



 **VEGRRE235**

Mercedes

A6461420019 - A6461420119



 **VEGRRE236**

BMW

11717805447 - 11717810166



 **VEGRRE237**

Volvo

70057503 - 30677714



 **VEGRRE238**

Hyundai, Kia

28410 - 2A300



 **VEGRRE239**

Hyundai, Kia

28410 - 2A350



 **VEGRRE240**

Audi, Volkswagen

059131503H - 70030904



 **VEGRRE241**

Toyota

25800-33011



 **VEGRRE242**

Renault

H8200836385 - 8200846454C



 **VEGRRE243**

Mercedes

A6401401160 - 70030618



 **VEGRRE244**

Opel

55567724



 **VEGRRE245**

Ford

9671398180 - V29004027



 **VEGRRE246**

Renault

7700873528 - 2580010



 **VEGRRE247**



 **VEGRRE248**

BMW

11717789999 - 11717804379



 **VEGRRE249**

BMW

11717792077 - 11717804381 - 7804381



 **VEGRRE250**

Opel

97107192 - 1350003960



 **VEGRRE251**

Hyundai, Kia

11409353



 **VEGRRE252**

Nissan

72275500



 **VEGRRE253**

Audi

03L131512BQ



 **VEGRRE254**

Audi, Volkswagen

03L131512AR



 **VEGRRE255**

Citroën, Peugeot

1618PS - 9678163380



 **VEGRRE256**

Volkswagen

03L131512AQ - 03L131512BN



VEGRRE257

Renault

8200762517 - 8201027384
147106293R



VEGRRE258

Mercedes

6421400160 - 6421400860
6421400360



VEGRRE259

Fiat, Iveco

500322055



VEGRRE260

Mercedes

6421401860 - 6421400460



VEGRRE261

Citroën, Ford, Peugeot, Volvo

1618KL - 1682007 - 30725803



VEGRRE262

Ford, Land Rover

LR003830 - LR006986 - LR009702
LR013321



VEGRRE263

Volkswagen

038131501N



VEGRRE264

Volvo

30774848 - 36000997



VEGRRE265

Audi, Volkswagen

057131501C/D/E/F/G



VEGRRE266

Audi, Volkswagen

059131502B



VEGRRE267

Citroën, Ford, Peugeot, Volvo

1685740 - 1618LC - AV6Q9D475AB



VEGRRE268

Volkswagen

03L115512A



VEGRRE269

Volvo

36001487



VEGRRE270

Volkswagen

03L131512BM - 03L131512Q



VEGRRE271

Ford

BG9Q9Y456AC - 1701764



VEGRRE272

Ford

1338675 - 1526689 - 1682737



 **VEGRRE273**

Mitsubishi

K5T70094 - ME193913 - 8130



 **VEGRRE274**

Ford

9678257280 - V29912928



 **VEGRRE275**

Opel, Renault

8200223028 - A2C53021612



 **VEGRRE276**

Nissan

147105M30B



 **VEGRRE277**

Hyundai

28410-2A850



 **VEGRRE278**

Opel, Renault

8200222772



 **VEGRRE279**

Skoda, Volkswagen

03P131512D



 **VEGRRE280**

Toyota

25800-26010



 **VEGRRE281**

Mitsubishi

K5T70071



 **VEGRRE282**

Mercedes

A6480900154



 **VEGRRE283**

Ford

954F9D45BA - 72206001



 **VEGRRE284**

Isuzu

8973815606 - K5T70580



 **VEGRRE285**

Tabella di comparazione valvole EGR

COD.	CODICE OEM	MEAT	APPLICAZIONI
VEGRRE01	46477364 - 17094174 - 555131 - 46477364 - 83732 - 7518177 - 72480923 - 14989	88177	Tempa 1.6 ie
VEGRRE02	46778198 - 46535796 - 72294700 - 722947010 - 72294702 - 722947020 - 72294708		1.9 Ds 44/46/59 Kw
VEGRRE03	55201144 - 55184651 - 93177422 - 5851049 - 851364 - 851758 - 18111 - 84E50 - 55219498 - 851744 - 93189335 - 93196798 - 71793804 - 71723449 - 71788559 - 93189798 - 851364 - 700020240 - 700020140 - EG1025712B	88543	1.3 Mjet 51/55/66 Kw
VEGRRE04	55204235 - 55182482 - 55215029 - 46785766 - 71788628 - 60816439 - 71723451 - 851757 - 18520 - 79G51 - 7518007	88007	1.9 8v Jtd 74/77/85/88 Kw
VEGRRE05	55204250 - 93181981 - 468223850 - 55194735 - 5851067 - 55215031 - 5851056 - 851341 - 717223453 - 71793807 - 7218015	88015	1.9 16v Mjet da 93 a 129 Kw
VEGRRE06	9659694748 - 1618R5 - 1618HQ - 83829 - 9665752480 - 71789686 - 71789686 - 71793436 - 1480560 - 1466340 - 8C1Q9D475BA - 6C1Q9D475AG - 8C1Q9D475AA - 1480549 - 6C1Q-9D475AF		2.2 D Mjet 74 Kw
VEGRRE07	14710BN701 - 8200656008 - 8200247250 - 8200130609 - 8200164563 - 8200488774 - 8200004883 - 8200469586 - 7518013 - 722818030 - 722818580 - 722818160 - 72281845 - 722818260 - 722818490 - 722818588 - 722818450 - 722818500 - 722818010 - 722818030 - 555033 - 83.638 - 7518013 - 7518513 - FDR146 - 83638IT	88013, 88513	Tutti i 1.5 dci 1.5 Ddis 4 Wd
VEGRRE08	5851591 - 9157671 - 851593 - 09157671 - 09157671 - 09158987 - 55351260 - 5851607 - 93185000 - 1008510593 - 555037 - 7518035 - CV1018612B1 - 83629 - 0851593 - 05851591 - 009158987 - 9157671 - 055351260 - 009157671 - 722875130 - V40630011 - 09157671	88035	1.0 12v 43/44 Kw, 1.2 16v 55/59 Kw, 1.4 16v 66 Kw
VEGRRE09	5851604 - R1090061 - 851038 - 851024 - 851024 - 5851024 - 93184997 - 17200272 - 851039 - 17098055 - 7518003 - 724809100 - 72480900 - 1000312B1 - 555019 - 83647 - 65801 - 103694 - 107072	88003	1.4 16v 66 Kw, 1.6 i 16v da 55 a 74 Kw, 1.8 i 16v da 81 a92 Kw
VEGRRE10	9659694748 - 1618R5 - 1618HQ - 83829 - 9665752480 - 71789686 - 71789686 - 71793436 - 1480560 - 1466340 - 8C1Q9D475BA - 6C1Q9D475AG - 8C1Q9D475AA - 1480549 - 6C1Q-9D475AF		2.2 D Mjet 74 Kw
VEGRRE11	9659694748 - 1618R5 - 1618HQ - 83829 - 9665752480 - 71789686 - 71789686 - 71793436 - 1480560 - 1466340 - 8C1Q9D475BA - 6C1Q9D475AG - 8C1Q9D475AA - 1480549 - 6C1Q-9D475AF		2.2 D Mjet 74 Kw
VEGRRE12	72264508 - 722645040 - 722645020 - 722645080 - 722645050	88018	Smart for Two 0-8 D
VEGRRE13	038131501G - 555062 - 045131501L - 038131501E - 03813151AQ - 045131501C - EG10312	88052	1.9 Tdi da 66 a 85 Kw
VEGRRE14	6756564 - 036131503M - 555020 - 722785130 - 722785170 - V10630002 - EG10294 - 7518047 - 03D131503D - 722785160 - 036131503M - 03D131503B - V10630006	88009 88047	1.2/1.4 da 44 a 47 Kw 1.4/1.6 16v da 55 a77 Kw
VEGRRE15	7518117 - 9681825280 - 9656612380 - 1618S8 - 82823 - 1436390 - 6M5Q9D475AA - 161831	88117	2.0 Hdi da 69 a 103 Kw
VEGRRE16	25620 - 27080 - 135000 - 8090		2.0 D-4D
VEGRRE17	90570476 - 5851020 - EG1028712B1 - 090117397 - 722414000 - 107070 - 851706 - 72241451 - 851708 - 7518002 - 555024 - 90543031 - 90570475 - FDR119 - 722414500 - 851708 - 5851027	88002	1.0 i 12v 40 Kw, 1.2 16v 48 Kw
VEGRRE18	8200270177 - 8200452876 - 70036801 - 70036804 - 700368040 - 700368050 - 8200550361 - 83743 - 700368010 - 70036805 - 8200561269 - 129586 - 14318	88091	1.5 Dci da 47 a 81 Kw
VEGRRE19	7518063 - 5851041 - 5851594 - 9196675 - 93176989 - 555038 - 4774311	88063	2.0 Tdi 16v 74 Kw, 2.0 Tdi 16v da 85 a 92 Kw
VEGRRE20	7518081 - 1313847 - 3M5Q9D475AC - 555014 - 700409 - 9651839180 - 1748264 - 9651889180 - 83605 - 1353152 - 3M5Q9D475CA - 700412 - 30750092 - 83622	88081 88084	1.6 Tdci 16v 80 Kw
VEGRRE21	6401400760 - 6401401160 - 6401401460 - 6401401860 - FDR258 - 7504F - 7518071 - 83745 - 555089 - 14980	88071	Classe A/B w169/245 da 60 a 103 Kw
VEGRRE22	11717804382 - 7791480 - 11717791480 - 11717791480 - 11717793484 - 11717804380 - 7804382 - 700450090 - 7793484	88191	2.0 D da 90 a 120 Kw, 2.5/3.0 da 120 a 210 Kw
VEGRRE23	7518048 - 96612545 - 555043	88048	Matiz 0.8 benzina 38 Kw
VEGRRE24	7518014 - 11717785452 - 7785794 - 11712248717 - 72252300 - 722523020 - 72252350 - 728340000 - 11712354070 - 7785789 - 2354070 - 2248717 - 722523500 - 722523030 - 7518193	88014	da 1.8 a 3.0 D
VEGRRE25	7518096 - 038131501AR - 038131501M - 14954 - 7283D - 555083 - 83741 - 104610 - V10630023	88096	1.9 Tdi da 66 a 81 Kw

COD.	CODICE OEM	MEAT	APPLICAZIONI
VEGRRE26	7518064 - 9128573 - 849087 - 849105 - 90530760 - 5338033 - 83733it - 849104 - V40630019 - ERV029 - 9117505 - 555076 - 72480924 - 72480927 - 83733	88064	2.0 Dti 16v da 60 a 82 Kw, 2.2 Dti 16v da 81 a 88 Kw
VEGRRE27	7518065 - 849124 - 849156 - 9192805 - 93170138 - 1108490156 - 555078 - 724809250 - 67921 - V40630020 - ERV025 - 83734IT - 72480924	88065	2.0 Dti 16v da 60 a 74 Kw, 2.2 Dti 16v da 81 a 92 Kw
VEGRRE28	7518051 - 038131501F/S/AN/AF - 038129637D - 555060 - 104612 - 83617 - V10630011 - 14953 - MN980163 - MN980325 - 7496D	88051 88551	1.9 Tdi da 66 a 85 Kw 2.0 Tdi 16v da 90 a 103 Kw
VEGRRE29	7518102 - 03G131501B/Q/J/R - 408275002001Z - 555066 - 10630009 - A2C53060455	88102	2.0 Tdi 16v da 100 a 125 Kw
VEGRRE30	7518054 - 038131501AD - EG1026012B1 - 700365000 - 70036503 - 700365030 - 700365060 - 555048 - V10630004	88054	1.9 Tdi da 55 a 96 Kw, 2.0 Tdi 16v da 100 a 103 Kw
VEGRRE31	038131501J - 038131501AA - 038131501AL - 1119320 - 6M219D475AA - 1M219D475AA - 1212966 - 1461304 - 7518069	88069	1.9 Tdi e Tdi quattro da 66 a 101 Kw
VEGRRE32	9658203780 - 1618N8 - 1618PF - 161846 - 256Q9D475BC - 1479845 - 1333611 - 7518085 - 256Q9D475BB - 1363591 - 1682736 - SU00100702 - SU00100730 - 6NU010171111 - 6NU010171121 - 216040594 - SU00100702	88085	1.4 Hdi 40/50 Kw, 1.6 Hdi 55/66/85 Kw
VEGRRE33	161859 - 1618NR - 9660276280 - 9672880080 - 1338675 - 5S6Q9D475AD - 7518086 - 216046799 - 6NU010171101 - 555187 - 1479057 - V29006980 - V25630001 - 6NU010171091	88086	1.6 Hdi 66/75 Kw, 1.6 Hdi 80 Kw
VEGRRE34	A6110900754 - A6110900554 - 72293105 - 72293106		2.2 Cdi
VEGRRE35	7518067 - 6680900454 - 6680900154 - FDR177 - 722387140 - 7234D	88067	1.7 Cdi da 44 a 70 Kw
VEGRRE36	7518094 - 55205455 - 55215032 - 55186214 - 5851596 - 5519734 - 93178886 - 93189082 - 107260 - 55186214 - 93169064	88094	1.9 Cdti da 74 a 110 Kw, 1.9 Jtd 8v da 88 a 96 Kw
VEGRRE37	9658203780 - 1618N8 - 1618PF - 161846 - 256Q9D475BC - 1479845 - 1333611 - 7518085 - 256Q9D475BB - 1363591 - 1682736 - SU00100702 - SU00100730 - 6NU010171111 - 6NU010171121 - 216040594 - SU00100702	88085	1.4 Hdi 40/50 Kw, 1.6 Hdi 55/66/85 Kw
VEGRRE38			
VEGRRE39	7518039 - 1628XV - 9641052380 - 256Q9D475AA - 1148077 - 256Q9D475AB - EG1030512B1 - 555010 - 6NU010171031 - 724809060	88039	1.4 Tdci 50 Kw, 1.4 Hdi 50 Kw
VEGRRE40	7518153 - a6461400760 - 555096 - 6461400460 - 129180 - 83888 - 7389D - 7353D - A6461400860 - IR88153 - 88181	83894 83888	2.2 Cdi da 75/90/110 Kw
VEGRRE41	7518080 - 215969659 - 1628WR - 555012 - 700408	88080	2.0 Hdi 16v 103 Kw
VEGRRE42	7518117 - 123196G - 1436390 - 9681825280 - 9656612380 - 161858 - 83823 - 6M5Q-9D475AA - 161831 - 1618GZ	88117	2.0 Hdi da 69 a 103 Kw
VEGRRE43	030131503F - 30131503F - 1441822740		1.0 37 Kw
VEGRRE44	8973550420 - 1108510748 - 98060795 - 1350007040 - 8973550420 - 97325019 - 0851748 - 7518228 - 83963	88228	1.7 Cdti 55/74 Kw
VEGRRE45	7518042 - 1148330 - 2S7Q9D475BA - 1333574 - 2S7Q9D475BC/BD - 1446265 - 14941 - 724809080 - 555071 - 83721 - 6NU01071011	88042	2.0 Tdci 16v da 85 a 96 Kw, 2.2 Tdci 114 Kw, 2.4 Tdci 101 Kw
VEGRRE46	7518094 - 55204249 - 55215032 - 55205455 - 552060490 - 555061 - 83604 - 722946240 - 722946270 - 722946220 - 722946380 - 107260	88094	1.9 Jtd M 8v da 74 a 110 Kw, 1.9 D Mjet da 85 a 96 Kw
VEGRRE47	7518045 - 5851029 - 90570477 - 90570478 - 9117397 - 555027 - 83643 - 722414010 - 722515010 - 722414080 - 114052	88045	Corsa B 1.2 i 16v 48 Kw
VEGRRE48	7518090 - 55556720 - 5851057 - EG1028912B1 - 555154 - 83744 - 722875160 - 103850 - 109649	88090	1.0 12v da 43 a 44 Kw, 1.2 16v da 48 a 59 Kw, 1.4 16v 66 Kw
VEGRRE49	7518052 - 038131501E/C/L - 55062 - 83621 - 72480917 - 724809170 - 107092 - 71655 - 103767 - 7293D	88052	1.2 Tdi 45 Kw, 1.4 Tdi da 55 a 66 Kw, 1.9 Tdi da 66 a 110 Kw, 2.5 Tdi da 114 a 120 Kw
VEGRRE50	XS409424AG027AA		1.8 Tddi
VEGRRE51	7518064 - 9128573 - 849087 - 849105 - 90530760 - 5338033 - 83733it - 849104 - V40630019 - ERV029 - 9117505 - 555076 - 72480924 - 72480927 - 83733	88064	2.0 Dti 16v da 60 a 82 Kw, 2.2 Dti 16v da 81 a 88 Kw
VEGRRE52	7701068109		3.0 Dci
VEGRRE53	11712244900 - 11712246145 - 117112247177 - 11712248139 - 2246145 - 2247177 - 555168 - 83.697 - 107246 - 721920600 - 721920110 - 721920620 - 721920500 - 721920000	88028	2.5 Td/Tds da 85 a 105 Kw
VEGRRE54	7518011 - 91124463 - 93160741 - 4404463 - 4411697 - 8200088888 - 8200169634 - 555031 - 83.646 - 107395 - 103743 - 722818390 - 722848590 - 722818060 - 722818340	88011	2.2 Dt i da 66 a 110 Kw, 2.5 Dt i da 84 a 99 Kw

COD.	CODICE OEM	MEAT	APPLICAZIONI
VEGRRE55	7518012 - 93160003 - 9316219 - 93161487 - 93183146 - 93160754 - 93161069 - 93188701 - 555032 - 83.653 - 107388 - 722818570 - 722818020 - 72281838 - 722818300 - 722818370	88012	1.9 Dt i da 59 a 74 Kw, 1.9 Dc i da 60 a 88 Kw
VEGRRE56	7518056 - 8200157971 - 8200282879 - 8200293950 - 8200360201 - 8200467030 - 555183 - 83.718 - 183838 - 72281861 - 722818420 - 722818180 - 722818530 - 72281862 - 722818330 - 722818550 - 722818360 - 722818620	88056	1.9 Dc i 88 Kw
VEGRRE57	7518093 - 8200374875 - 555093 - 83.719 - 722818630 - 109648	88093	2.2 Dc i da 66 a 110 Kw, 2.5 Dt i 99 Kw
VEGRRE58	53418200 - 98T274 - 985697901 - 98T342 - 9128168 (completa di collettore)		1.7 8v 55 Kw
VEGRRE59	6X719F479BB - 0261230172 - 988F9B989 - BB8H8F9B989 - 1697822 - 6X4Q9D475AE		2.0 Tdc i da 66 a 107 Kw, 2.2 Tdc i da 110 a 114 Kw
VEGRRE60	8200507299 - 8200796571 - 8200194323 - 8200630740 - 8200850755 - 1811167JG3 - 555202 - A2C53322451 - 147106672R - 7518226 - A2C59515008	88226	1.9 Dc i da 81 a 96 Kw
VEGRRE61	2562033030 - 1350008120 - DEG0100		1.4 D-4D 66 Kw
VEGRRE62	A6401401260 - 70030620	88211	0.8 Cdi da 30 a 40 Kw
VEGRRE63	5344544 - 1582A037 - K5T70081		3.2 D
VEGRRE64	7518107 - 9633602180 - 1628JZ - 16285V - 555209 - 83814 - 722843060 - 72284306 - 129584	88107	2.0 Hdi da 66 a 100 Kw
VEGRRE65	7518119 - 03G13501A - 555088 - 83.824 - 108948 - 7451D	88119	1.9 Tdi 77 Kw
VEGRRE66	A6421400860 - A6421400360 - 83.932 - 7518204 - 7527D	88204	2.8/3.2 Cdi da 140 a 173 Kw
VEGRRE67	7518038 - 46460132 - 83.727 - 722552000 - 71788536 - 71788537	88038	1.9 Jtd 8v 77 Kw, 2.4 Jtd da 91 a 100 Kw
VEGRRE68	7518133 - 2841027250 - 555095 - 83.786	88133	1.5 Crd i 60 Kw, 2.0 Crd i da 83 a 231 Kw
VEGRRE69	6570 - 9D475AC		
VEGRRE70	25620 - 26090		
VEGRRE71	03G131502 - 03G131502B - 555192 - 83840 - 7518152 - 710572D - 70090703	88152	1.4 Tdi 59 Kw, 1.9 Tdi da 55 a 77 Kw, 2.0 Tdi 103 Kw
VEGRRE72	18011PWA050 - ADH27216 - 18011PWA000 - 18011PWA010 - 18011PWA030 - 18011PWA040 - 18011PWA050 - H22202		1.3 Hybrid da 53 a 70 Kw, 1.4 benzina 61 Kw
VEGRRE73	03D131503A - 83.619 - 7518047	88047	1.2 12v da 47 a 51 Kw
VEGRRE74	14710AD20A - 14710AD203 - 14710AD20B		2.2 Dc i 111 Kw
VEGRRE75	7518095 - 045129637A - 045131501F/K - 555082 - 83.742 - 104609 - 7271D	88095	1.4 Tdi da 51 a 66 Kw
VEGRRE76	K5T70871 - RF7J20300 - ADM57212		1.5 Crdi da 60 a 81 Kw, 2.0 Di da 89 a 105 Kw
VEGRRE77	A6391400560 - 83.938 - 7518211 - A6601400360	88211	0.8 D da 30 a 40 Kw
VEGRRE78	7518072 - 036131503R/T - 555047 - 83.627 - 103791 - 728248170 - 72824816	88072	1.4 16v da 55 a 74 Kw, 1.6 16v 77 Kw
VEGRRE79	7518083 - 1618N7 - JDE3315 - WAV500210 - 555011 - 83.640 - 700411	83083	2.0 Hdi 24v da 140 a 152 Kw
VEGRRE80	14710 - MA70A - 150100 - 0011		3.0 Dci
VEGRRE81	7518122 - 96325535 - 555073 - 83.826	88122	1.0 47 Kw
VEGRRE82	7518103 - 55209609 - 555067 - 83.665 - 71749240	88103	1.6 Jtd M da 77 a 88 Kw, 1.9 Tti M da 132 a 140 Kw
VEGRRE83	7518005 - 028131501A - 02131508 - 0281131501E - 555028 - 83.645 - EV0004 - 72172306	88005	1.9 Tdi da 47 a 81 Kw
VEGRRE84	7518008 - 05851002 - 5851002 - 090469560 - 90469560 - 555025 - 83.637 - 72189800	88008	1.8 i 16v 85 Kw, 2.0 i 16v 100 Kw
VEGRRE85	98060796 - 851749 - HU1350007130 - HU1350007351 - 8973586130 - 0851749 - 1108540749 - 0851749 - V40630017		1.7 Cdti da 59 a 74 Kw
VEGRRE86	7518016 - 55182483 - 55204236 - 55215030 - 46530857 - 46778209 - 555035 - 83620 - 103852 - 722946280 - 722946330 - 722946160 - 72294600 - 722946190 - 722946170 - 722946010 - 72246140 - 72294625 - 722946030 - 722946020 - 722946100	88016	1.9 Jtd da 59 a 77 Kw

COD.	CODICE OEM	MEAT	APPLICAZIONI
VEGRRE87	7518017 - A0021401360 - 0021401360 - 83.726 - 98116 - 14912 - 72084110 - 720849640	88017	3.2 da 154 a 170 Kw
VEGRRE88	7518019 - A0011409660 - 0021400260 - 720849620	88019	6.0 AMG da 280 a 300 Kw
VEGRRE89	7518020 - A0021400260 - 0021400260 - 555022 - 720850320 - 7208507820 - EG1018012B1	88020	2.8 da 142 a 145 Kw, 3.2 da 162 a 170 Kw, 3.6 200 Kw
VEGRRE90	7518022 - 7700869607 - 722182510	88022	1.4 E 55 Kw
VEGRRE91	7518023 - A1121400060 - 1121400060 - EG1037212B1 - 722136500	88023	2.3 125 Kw, 2.8 da 145 a 150 Kw, 3.2 da 158 a 165 Kw
VEGRRE92	96FF9D475BB/BC/BD - 1005563 - 1012816 - EG1028312B1 - 722165000 - 14937	88024	1.8 D 44 Kw
VEGRRE93	7518025 - 046131503 - 046131503A - 721675010 - 721675030 - 721675040 - 83.685 - 721675160	88025	2.5 Tdi da 84 a 103 Kw
VEGRRE94	7518026 - 059131503 - EG1026912B1 - 721675050 - 721675051 - 721675170 - 721675550 - 555036 - 83.616	88026	2.5 Tdi da 110 a 150 Kw
VEGRRE95	7518027 - 028131501M - 83.688 - 721723550	88027	1.9 Tdi 66 Kw
VEGRRE96	7518029 - WAV100220 - 83.698 - 721943050 - WAV100220 - 14917 - FDR108 - 721943020	88029	2.0 Sdi da 63 a 77 Kw
VEGRRE97	7518031 - 0021401760 - A0021401760 - 555072 - 83.700 - 0892020 - 721949530 - 721949031	88031	2.5 110 Kw
VEGRRE98	7518032 - 7700102850 - 7700105136 - 7700108141 - 770858510 - 7700100230 - 83.702 - 722011530	88032	2.2 D 61 Kw
VEGRRE99	7518034 - 954F9D475DA/DB/DC - 722064000 - 722064020 - 722064520 - 1114698	88034	2.5 Td/Di da 63 a 85 Kw
VEGRRE100	7518036 - 722074010 - 722074020 - 83.708 - 14927 - 722074000 - 722074030 - 722074520	88036	2.5 Tdi da 83 a 90 Kw
VEGRRE101	7518037 - 5851580 - 55017 - 83.635 - 14950 - EG1029112B1 - 1158510580 - 1058510580 - 12569552 - 5851580 - 12571041 - 72263017 - 722630200	88037	2.2 i 16v 108 Kw
VEGRRE102	7518040 - 1S7G9D475AG - EG1030412B1 - 1144210 - 1358360 - 724809050 - 1S7G9D475AF - 1S7G9D475AH - 555039 - 83.624 - 14983	88040	2.0 16v 107 Kw, 2.3 16v 110 Kw
VEGRRE103	7518041 - 2S7Q9D475AC - 1333572 - FDR138 - 724809070 - 14940 - 555069 - 83.721 - 83.667 - 0892024 - 2S7Q9D475BA - 2S7Q9D475AC - ERV003	88041 88042	2.0 Di da 63 a 74 Kw 2.4 Tddi da 66 a 120 Kw
VEGRRE104	7518044 - 46477397 - 83.667 - 46466454	88044	1.9 Td da 55 a 74 Kw, 2.5 Td 92 Kw
VEGRRE105	7518046 - 5854586 - EG1031012B1 - 555041 - 555054 - 83.639 - 24445720 - 728384120 - 728384130 - 14314 - 14900 - 17087248	88155	1.6 16v da 76 a 77 Kw
VEGRRE106	7518047 - 03D131503B - 555051 - 722785120 - 722785160 - V10630006 - 03D1131503D - 83.619 - 270156 - 14322 - ERV095	88047	1.2 12v da 47 a 70 Kw
VEGRRE107	7518049 - 9628355780 - 1628JF - EG1025612B1 - 83.724 - 724809220 - 6NU010171071	88049	2.0 16v da 97 a 100 Kw
VEGRRE108	7518050 - 06A131501F - EG1029012B1 - 555046 - 722574120 - V10630007 - 06A131501P - 83607 - 14321	88050 83607	1.4 16v da 55 a 77 Kw, 1.6 16v da 74 a 77 Kw, 2.0 i 85 Kw
VEGRRE109	7518053 - 038131501AG - 038131501AH - 83.717 - 14986 - 722477100 - 722477110 - 72247708 - 722477050 - 722477020 - 72247702 - EG1036012B1 - 14986 - 14987 - 038131501BB - 038131501C - 038131501AH/BC/AG	88053	1.7 Sdi da 42 a 44 Kw, 1.9 Sdi da 47 a 50 Kw, 2.0 Sdi 51 Kw
VEGRRE110	7518057 - 0928400425 - 1628PB - 96381115 - 9631854180 - 555151 - 83.729	88057	1.9 D 51 Kw
VEGRRE111	7518058 - 0928400427 - 555153 - 83.731 - 9638111280 - 96381114 - 96381112 - 1628TA	88058	1.9 D 51 Kw
VEGRRE112	7518059 - 0928400426 - 555152 - 83.730 - 96381113 - 1628PA	88059	1.9 D 51 Kw
VEGRRE113	7518060 - 0928400424 - 555150 - 83.728 - 9638111480 - 96381114 - 1628PC	88060	1.9 D 51 Kw
VEGRRE114	7518061 - 0928400428 - 83.810 - 0928400408 - 96366756 - 1628JY	88061	1.9 D 51 Kw
VEGRRE115	7518066 - 21402660 - 0021402660 - 7159D	88066	2.3 Td 72 Kw
VEGRRE116	7518068 - 038131501T - 83.746 - 72480926 - 724809260 - 129585 - ERV034 - 14961 - 101310501038AT - 7371D	88068	1.9 Td da 96 a 110 Kw
VEGRRE117	A6400901470 - A6400902070		Classe A/B w169

COD.	CODICE OEM	MEAT	APPLICAZIONI
VEGRRE118	7518074 - 2580018A - 16287T - 9619452580 - 555004 - 83.641 - 700401 - 14963	88074	1.9 Td da 66 a 68 Kw
VEGRRE119	7518075 - 2580022A - 16289Z - 9630820780 - 555000 - 83.611 - 700402	88075	1.5 D da 40 a 42 Kw
VEGRRE120	7518077 - 2580027A - 1628CF - 9630651780 - 555003 - 14965 - 9619452580 - 16287T	88077	1.9 D da 47 a 50 Kw
VEGRRE121	7518078 - 2580103B - 9657912780 - 161800 - 555005 - 83.657 - 1628JZ - 1618Q0 - 1628WV - 9640341280 - 9635651080	88079	2.0 Hdi 66 Kw
VEGRRE122	7518079 - 2580129A - 1628VW - 9635651080 - 555008 - 700406 - 83.657 - 83.644 - 9640341280 - 700405	88078 88079	2.0 Hdi 62 Kw
VEGRRE123	7518082 - 215987681 - 1618N6 - JDE3314 - 1316149 - 555009 - 700410 - 8.645 - 14970	88082	2.7 Hdi da 140 a 152 Kw
VEGRRE124	7518084 - 216049521 - 3M5Q9D475CA - 1353152 - 555013 - 83.662 - 14972 - 700412 - 700446 - 30750092 - 0892006	88084	1.6 Tdci 66 Kw
VEGRRE125	7518086 - 216046799 - 555006 - 555187 - 555111 - 83.613 - 700444 - 700414 - 5S6Q-9D475AA - 161859 - 1439414 - 1618NR - 1682737 - 5S6Q9D475AE - 5S6Q9D475AD	88086	1.6 Hdi 66/75 Kw, 1.6 Hdi 80 Kw
VEGRRE126	7518088 - 06A131501G - 555049 - 83.618 - 14323 - V10630005 - EG1029512B1 - 722785180 - 722785140 - EG1029512B1	88088	1.8 20v 92 Kw
VEGRRE127	7700867485 - 555050 - 722130500 - 72213000 - EG1028212B1 - 722130001 - 14933	88089	1.6 E 66 Kw
VEGRRE128	7518087 - 216035358 - 555007 - 83.652 - 700415 - 700418 - 03L131501E - 03G131501P - 03L131501G - 03L131501D - 03G131501 - 14975 - 700424	88087	2.0 Tdi 16v da 103 a 125 Kw
VEGRRE129	7518127 - 284104X900 - 555121 - 83.789 - 284104X900	88127	2.9 Crdi 136 Kw
VEGRRE130	55201144 - 55184651 - 93177422 - 5851049 - 851364 - 851758 - 18111 - 84E50 - 55219498 - 851744 - 93189335 - 93196798 - 71793804 - 71723449 - 71788559 - 93189798 - 851364 - 700020240 - 700020140 - EG1025712B	88543	1.3 Mjet 51/55/66 Kw
VEGRRE131	27518135 - 84104A510 - 555129 - 83.798 - 284104A010 - AEGR694	88135	1.6 Crdi 85 Kw
VEGRRE132	7518097 - 045131501D - 555084 - 83.747 - 7301D - ERV058 - 045131501	88097	1.4 Tdi 55 Kw
VEGRRE133	7518098 - 074129463A - 555079 - 83.740 - 14977 - 7223D - ERV057 - 104607	88089	2.5 Tdi da 66 a 111 Kw
VEGRRE134	7518100 - 070128070B - 555091 - 83.737 - 070128070E - 14981 - 7649D - ERV061 - 104616	88100	2.5 Tdi da 96 a 128 Kw
VEGRRE135	7518101 - 070128070F - 555092 - 83.738 - 070128070C - 14982 - AEGR814 - 7650D	88101	2.5 Rs Tdi 128 Kw
VEGRRE136	75188099 - 61109000345 - 555077 - 83.739 - 14955 - 6110900954 - 7206D	88099	2.2 Cdi da 60 a 95 Kw
VEGRRE137	7518104 - 55566052 - 555068 - 83.805 - 055566052 - AEGR921	88104	2.0 Cdi 118 Kw
VEGRRE138	7518105 - 97353973 - 555181 - 83.812 - 8973539730 - 722772090 - 129587 - 860441	88105	1.7 Dti 16v da 48 a 55 Kw
VEGRRE139	7518106 - 851151 - 8973184760 - 8980919250 - 97184925 - 72277212 - 129583 - 555185 - 83.813 - 851151 - 722772040 - 722772030 - 722772120 - 98091825	88106	1.7 Tdi 16v da 48 a 55 Kw
VEGRRE140	7518108 - 504099669 - 504345920 - 83.815 - 7497D	88108	2.3 Mjet da 88 a 96 Kw
VEGRRE141	7518109 - 9638035080 - 83.816 - 14990 - 72288801 - 1628nn - 722888020 - XEGR44	88109	2.2 Hdi 98 Kw
VEGRRE142	7518110 - 8200797706 - 408265001014 - 8200693739 - 8200797714 - 8200797725 - 83.817 - H8200327011 - AEGR736 - 8200327011 - 408265001014Z	88110	2.0 Dci da 66 a 133 Kw
VEGRRE143	7518123 - 5851025 - 83.797 - 555128 - 96408500 - 25182127 - EG1011712B1 - 17092164 - 17115225	88123	0.8 38 Kw, 1.0 49 Kw
VEGRRE144	7518112 - 8200796571 - 83.818 - 8200411031 - H8200194323 - 8200796572 - 8200796578 - 8200796588 - 408265001010Z - 1811167JG3 - AEGR719	88112	1.9 Dci da 81 a 96 Kw
VEGRRE145	7518113 - 06F131503B - 83.819 - 06F131503A - 40B265001002Z - AEGR721	88113	2.0 Fsi 110 Kw
VEGRRE146	7518114 - 03C131503B - 83.820 - 408 - 65001005Z - V10630012 - A2C53025941 - AEGR720	88114	1.4 Fsi 63 Kw, 1.6 Fsi 85 Kw
VEGRRE147	7518115 - 7701058850 - 7701065038 - 8200463548 - 8200467059 - 8200542999 - 83.821 - 14992 - 7701067308 - V46630001 - 70007504	88115	1.9 Dci da 66 a 96 Kw, 2.0 Dci 110 Kw
VEGRRE148	7518116 - 555090 - 162642 - 83.822 - 14300 - 7631D - 504105569 - 504121701 - XEGR66	88116	3.0 Hdi 116 Kw
VEGRRE149	284104A010 - 555129 - 83.798 - AEGR694	88135	1.6 Crdi 85 Kw

COD.	CODICE OEM	MEAT	APPLICAZIONI
VEGRRE150	7518120 - 1628VT - 83.825 - 1628VT - 14993 - AEGR624 - 722843070 - 9640185580 - 72284302 - 129588 - 42630001 - V42630001	88120	2.0 Hdi da 66 a 100 Kw
VEGRRE151	7518124 - 71753846 - 83.827 - 55207921 - 70159904 - 70159910 - 701599100 - 55216292 - 71753846 - 5851089 - 701599040	88124 88146	3.0 Hdi 116 Kw
VEGRRE152	71739811 - 83.837 - 7518147 - 71788546	88147	1.6 16v 77 Kw
VEGRRE153	55201144 - 55184651 - 93177422 - 5851049 - 851364 - 851758 - 18111 - 84E50 - 55219498 - 851744 - 93189335 - 93196798 - 71793804 - 71723449 - 71788559 - 93189798 - 851364 - 700020240 - 700020140 - EG1025712B	88543	1.3 Mjet 51/55/66 Kw
VEGRRE154	55201144 - 55184651 - 93177422 - 5851049 - 851364 - 851758 - 18111 - 84E50 - 55219498 - 851744 - 93189335 - 93196798 - 71793804 - 71723449 - 71788559 - 93189798 - 851364 - 700020240 - 700020140 - EG1025712B	88543	1.3 Mjet 51/55/66 Kw
VEGRRE155	7518141 - 9638374180 - 1628XP - 71788564 - 83.832 - 72806904 - 14302 - 728069040	88141	2.0 Hdi da 79 a 94 Kw
VEGRRE156	7518142 - 9656911780 - 83.833 - 700057805	88142	2.2 Jtd da 79 a 80 Kw
VEGRRE157	7518144 - 9637517280 - 1628RH - 9638231480 - 72806901 - 83.834 - 14306 - 728069030	88144	2.0 Jtd da 79 a 80 Kw
VEGRRE158	7518145 - 71747145 - 83.835 - 1811169G01	88145	1.6 16v 4x4 79 Kw
VEGRRE159	7518146 - 71753849 - 71769760 - 83.836 - 55577950 - 70362203 - 851048 - 851074	88146	1.3 Mjet da 55 a 70 Kw
VEGRRE160	059131501D - 059131501C - 059131501H - 701782070 - 4050326345879 - 59131501H		2.7 V6 Tdi da 120 a 140 Kw, 3.0 v6 Tdi da 155 a 176 Kw
VEGRRE161	11717801942 - 7801942 - 70068408 - 700684080 - 70068410 - 70068414 - 700684140		2.0 D da 85 a 130 Kw
VEGRRE162	163638 - 163671 - 504105594 - 504345917 - 04001620016 - 104614 - 83.828 - 7523D	88136	3.0 Hdi 116 Kw
VEGRRE163	4M5Q9424BD - 2640264849 - 2731250391 - 4M5Q9424CC		1.8 Tdci 85 Kw
VEGRRE164	Honda		
VEGRRE165	RF3F20300A		
VEGRRE166	7518076 - 7700101088 - 555001 - 83.748 - 700403	88076	1.9 D 40 KW
VEGRRE167	72257402 - EG10309 - 103766 - 036131503R - 06A131501F - 06A131501P - 83-607 - 7518050 - 14231 - V10630007 - 722574120 - 0892050	88050	1.4 16v da 55 a 74 Kw, 1.6 da 74 a 77 Kw, 3.0 da 74 a 85 Kw
VEGRRE168			
VEGRRE169	7518130 - 284102A100 - 555130 - 83.794 - 2841027400 - AEGR686	88130	2.2 Crdi da 102 a 114 Kw
VEGRRE170	0021402660 - 0021400060 - 7518066 - 7159D	88066	2.3 Td 72 Kw, 2.9 Td da 75 a 90 Kw
VEGRRE171	7518131 - 284104A410 - 555125 - 83.793 - 0892053	88131	2.5 Crdi da 103 a 125 Kw
VEGRRE172	7518129 - 2841027410 - 555122 - 83.790 - 2841027410 - 0892044	88129	2.0 Crdi 103 Kw
VEGRRE173	7518149 - 504150396 - 555208 - 83.838 - K5T76374	88149	2.3 Mjet da 88 a 96 Kw
VEGRRE174	89737666632 - K5T70380 - 0851802 - 5851076		1.7 Cdti
VEGRRE175	7518178 - A6281400060 - 090413214Q4 - A6281420119 - A6281400160 - 7396D - 83.808	88178	4.0 Cdi da 184 a 191 Kw
VEGRRE176	25620 - 33010 - 2562033010		1.4 D-4D
VEGRRE177	A2C53027341 - 14710DB002 - 1096B - 408265001011Z - Z231000QAA - 14710DB001 - 4415143 - 4416427 - 93180002 - 93180002 - 93187848 - 7701058063 - 7701063353		3.0 Dti
VEGRRE178	7518186 - 6421401760 - A6421401760 - 83.891 - 710476D	88186	1.8 Kompressor 120 Kw, 3.0 Cdi da 135 a 150 Kw
VEGRRE179	7518141 - 9638374180 - 9638374480 - 1628XP - 72806904 - 728069040 - 83.832 - 14302	88141	2.0 Hdi/Jtd da 79 a 94 Kw
VEGRRE180	A6110900554 - W701329 - 72293100		2.7 Cdi
VEGRRE181	8200222772 - A2C5309175		2.5 Dci

COD.	CODICE OEM	MEAT	APPLICAZIONI
VEGRRE182	17270013R		
VEGRRE183	17370032L		
VEGRRE184	96253548 - 030351 - 96222508		1.6 L 8v 78 Kw
VEGRRE185	72829005 - 49002021F		2.5/2.8 Crd 16v
VEGRRE186	YC1Q9475BF - YC1Q9D475BF		2.4 Dtd da 66 a 92 Kw
VEGRRE187	79376K6266 - W249476		1.6 Td MPS 84,5 Kw
VEGRRE188	6651400660 - 6651400560 - 664140026A - D27DTD20DT		2.7 Xdi 120 Kw
VEGRRE189	07Z131501A - 83.856 - 7518121 - 14979 - 7268D - AEGR928 - 555081	88121	5.0 V10 Tdi 230 Kw
VEGRRE190	96408500 - 96291087 - 96291087 - 555058 - 555128 - 83.608	88123	0.8 Benzina 38 Kw
VEGRRE191	7518128 - 284102A120 - 555124 - 83.792 - 0892052 - 0892052	88128	1.5 Crdi da 55 a 85 Kw
VEGRRE192	2841027001 - 555123 - 83.791 - 2841027000 - 0892045	88132	2.0 Crdi da 83 a 92 Kw
VEGRRE193	284104X510 - 555120 - 83.787 - 7518134 - 0892043 - 284104X510	88134	2.9 Crdi 106 Kw
VEGRRE194	038131501AB - 03812963TL - 038131501AM - 83.839 - 7327D - 555085 - 7518151 - 14303 - V10630024 - ERV076	88151	1.9 Tdi 96 Kw
VEGRRE195	7518156 - 96291087 - 17092164 - 17112655 - 25182127 - 0892017 - ERV069 - 555085 - 83.608 - 14996	88156	1.5 16v da 66 a 80 Kw, 2.0 16v 98 Kw
VEGRRE196	0011409560 - 0011404860 - 720850110 - 72085031 - 555044 - 83.625 - 7518157	88157	2.6 8v da 118 a 122 Kw, 3.0 8v da 132 a 170 Kw
VEGRRE197	0011406560 - 0011409160 - 555045 - 83.626 - 7518158 - EG1018612B1 - 721949510 - 0021401060 - 720820520 - 721819100 - 72181960	88158	2.5 D da 66 a 69 Kw, 3.0 D da 80 a 108 Kw, 3.5 D da 100 a 110 Kw
VEGRRE198	17096243 - 5851009 - 555026 - 83.642 - 5851009 - 1058510009 - 7518160 - 0892011 - 724809130 - 14907 - V40630003 - EG10007 - EG1000712B1	88160	2.5 i V6 da 125 a 143 Kw
VEGRRE199	9198821 - 05851608 - 17094107 - 83.650 - 7518161 - 17094107 - 14906 - 017094107 - EG1001512B1 - 40630002	88161	2.2 16v 106 Kw, 2.5 v6 125 Kw, 2.6 v6 132 Kw, 3.0 v6 155 Kw, 3.2 v6 160 Kw
VEGRRE200	0011408260 - 0011409460 - 555144 - 7518162 - 72085041 - 720850410 - 103880 - 83.676	88162	2.3 8v da 97 a 100 Kw
VEGRRE201	6563542 - 7091568 - 91FF9D475BB - 83.686 - 72167600 - 721676000 - 14914 - 91FF-9D475BC - 7518163 - 0892019	88163	1.8 Td 66 Kw
VEGRRE202	11407660 - 53489 - 721703500 - 0011407660 - 83.687 - 7518164 - A0011407660 - 0011407660	88164	4.2 da 205 a 210 Kw, 5.0 da 235 a 240 Kw
VEGRRE203	6461400860 - 7353D - 83.894 - V03630006 - 555165 - 14304 - V30630006		2.2 Cdi da 65 a 150 Kw, 2.7/2.8 Cdi 130 Kw, 3.0 Cdi 170 Kw, 3.2 Cdi da 130 a 150 Kw
VEGRRE204	6120980417 - 83.893 - 7256D - V30630005 - 367873		2.5 Crdi 105 Kw, 2.7 Cdi 115 Kw, 2.8 v6 24v 150 Kw
VEGRRE205	6110900254 - 83.892 - V30630004 - 7220D - AEGR925 - 555149 - T3111214567		2.2 Cdi da 60 a 129 Kw
VEGRRE206	6461400860 - 7353D - 83.894 - V03630006 - 555165 - 14304 - V30630006		2.2 Cdi da 65 a 150 Kw, 2.7/2.8 Cdi 130 Kw, 3.0 Cdi 170 Kw, 3.2 Cdi da 130 a 150 Kw
VEGRRE207	6461400860 - 7353D - 83.894 - V03630006 - 555165 - 14304 - V30630006		2.2 Cdi da 65 a 150 Kw, 2.7/2.8 Cdi 130 Kw, 3.0 Cdi 170 Kw, 3.2 Cdi da 130 a 150 Kw
VEGRRE208	504351131 - 83.907 - 7518187 - 54DTS3I - 802009814008	88187	2.3 Mjet da 88 a 96 Kw
VEGRRE209	1618N6 - JDE3314 - 1316149 - 555009 - LR018466 - 83.654 - ERV043 - 700410 - 7518082	88082	2.7 24v Hdi da 140 a 152 Kw
VEGRRE210	1618N7 - JDE315 - WAV500210 - C2C40184 - 83.640 - 14971 - 555011 - 7518083	88083	2.7 24v Hdi da 140 a 152 Kw
VEGRRE211	076131501A - 83.841 - 700823030 - 70082304 - 700823040 - 076131501A - 7518154 - 700823060 - AEGR738 - 555054	88154	2.5 Rs Tdi da 65 a 128 Kw
VEGRRE212	96335930 - 17089050 - 17201251 - EG10108 - 17089051 - EG1010811B1 - 17112106 - 14995 - 83.628 - 17112105 - 7518159 - 0892018 - 555059	88159	1.4 55 Kw, 1.5 da 44 63 Kw
VEGRRE213	6421401760 - 710476D - 83.891 - 7518186	88186	2.0 CDI 135, 3.0 Cdi da 135 a 150 Kw
VEGRRE214	074129499B - 555135 - 751866 - 72183402 - 721834520 - 73.691 - 14994 - EG1032612B1	88166	2.5 Tdi da 65 a 75 Kw

COD.	CODICE OEM	MEAT	APPLICAZIONI
VEGRRE215	684204 - 6842725 - 721835000 - 721835530 - 14910 - FDR101 - 555139 - 83.693 - 7518167 - 721835530 - EG1033712B1 - AEGR646	88167	2.3 i CAT da 82 a 140 Kw
VEGRRE216	A0011407060 - A0011408960 - 14316 - 7518171 - 0011407060 - 0021400960 - A0021400960 - 0021400460 - A0021400460 - 0011408960 - 721949520 - XEGR84 - ERV089	88171	2.5 Turbo D da 83 a 93 Kw
VEGRRE217	037131501D - 722057010 - 83.704 - 7518173 - ERV019 - 14911 - EG1031812B1 - 555133 - 72205701 - FDR102 - ERV019	88173	2.0 i Syncro 85 Kw
VEGRRE218	38131501 - 722477100 - 038131501BB - 038131501AG - 038131501C - 83.176 - 7518175 - 14986 - AEGR661 - ERV052 - XEGR55	88175	1.4Tdi 55 Kw, 1.7 Sdi da 42 a 44 Kw, 1.9 Sdi da 47 a 66 Kw, 2.0 Sdi 51 Kw
VEGRRE219	06A131501E - 06A131501N - 555141 - 72807000 - 72807004 - 728070040 - 06A13151E - 83.725 - 7518176 - 728070030 - XEGR73 - EG1033912B1 - 14327	88176 88676	1.8 T 20v 110 Kw, 2.0 Hdi 16v da 79 a 80 Kw
VEGRRE220	46477364 - 17094174 - 555131 - 46477364 - 83732 - 7518177 - 72480923 - 14989	88177	Tempa 1.6 ie
VEGRRE221	284102F000 - 83.897 - 7518180	88180	2.0 Crdi da 100 a 135 Kw
VEGRRE222	06A131501R - 06A131501P - 555046 - 7518150 - 72257414 - 722574120 - 312183650323	88150	1.6 16v 75 Kw
VEGRRE223	284104A100 - 7518179 - 2414448	88179	2.5 Crdi da 81 a 120 Kw
VEGRRE224	504388655 - 555190 - 31012 - AEGR939 - 7518188	88188	2.3 Mjet 96 Kw Bus
VEGRRE225	7518189 - 55191 - 5801385941 - 10205 - F1AE3481D	88189	2.3 Mjet 96 Kw Bus
VEGRRE226	49002023F	88190	2.7 4x4 Crd 120 Kw
VEGRRE227	03G131501E - 7529D - 14307 - ERV080 - XEGR59 - 7518210	88210	2.0 Tdi 130 Kw
VEGRRE228	03L131512CF/AP/AT/BB/BJ/BL/CH - 03L131512N - 125680506		1.6 Tdi 77 Kw
VEGRRE229	3074445 - 70056104 - W712076 - 70056104 - D5244T5 - 36050570 - 70057504 - 30774812		2.4 D R5 119 Kw
VEGRRE230	147105M001 - 147105M0002 - 4F1515 - EGR4204 - EGV878		1.6 16v da 66 a 78 Kw, 1.8 16v da 84 a 85 Kw
VEGRRE231	2562027090 - 1350008110		2.0 D-4D 85 Kw
VEGRRE232	A6110980417 - 6110980417 - 722387170 - 722614		2.2 Cdi 135 Kw
VEGRRE233	284104A470		2.2 D 4Eb
VEGRRE234	A6401401960 - 710073D - 6401401960 - 312123450242		2.0 Cdi da 60 a 103 Kw
VEGRRE235	13H10		1.0 Benzina 50 Kw
VEGRRE236	7518207 - A6461420019 - A6461420119 - 7610D - 6471420219 - 6461420119	88207	2.2 Cdi da 65 a 110 Kw
VEGRRE237	11717805447 - 117117810166 - 117117810871 - 7805447 - 7805447 - 7810166 - 7810871 - 161880 - 780544703 - 3159295553		2.0 D
VEGRRE238	70057503 - 30677714 - 36000997		2.4 D 136 Kw
VEGRRE239	284102A300 - 5561304519 - 241399 - 284102A350		1.6 Crdi
VEGRRE240	284102A350		
VEGRRE241	059131503H - 70030904		
VEGRRE242	25800 - 33011		
VEGRRE243	8200836385 - 8200846454C - 7518225 - 700368140	88225	1.5 Dci da 55 a 70 Kw
VEGRRE244	A6401401160 - 70030618		
VEGRRE245	55567724		
VEGRRE246	9671398180 - V29004027		
VEGRRE247	7700873528 - 7518073 - 2580010 - 700400	88073	
VEGRRE248	72264508 - 722645040 - 722645020 - 722645080 - 722645050	88018	Smart for Two 0-8 D

COD.	CODICE OEM	MEAT	APPLICAZIONI
VEGRRE249	7518194 - 11717789999 - 11717804379 - 7789999 - 7804379 - 72826402 - 728264070	88194	
VEGRRE250	7518192 - 11717792077 - 11717804381 - 7804381 - 7792077 - 700512030 - 11717804352 - 11717804351 - 7804351	88192 88196	2.0 D da 90 a 130 Kw, 2.5 D da 120 a 130 Kw, 3.0 D 170 Kw
VEGRRE251	97107792 - 1350003960		
VEGRRE252	11409353		
VEGRRE253	72275500		
VEGRRE254	7518200 - 03L131512BQ - 700436 - V29004491 - 555116 - AEGR938	88200	2.0 Tdi da 100 a 130 Kw
VEGRRE255	7518201 - 03L131512AR - 700438 - V29006736 - 555109 - AEGR933	88201	2.0 Tdi da 100 a 125 Kw
VEGRRE256	7518203 - 018PS - 9678163380 - 700441 - V29006934 - 555114 - AEGR937	88203	2.2 Hdi 150 Kw
VEGRRE257	7518202 - 03L131512AQ/BN - V29006759 - 555110 - AEGR936	88202	2.0 Tdi 103 Kw
VEGRRE258	7518199 - 8200762517 - 8201027384 - 147106293R - 700433 - V29001035	89199	1.5 Dci 81 Kw, 1.9 Dci 96 Kw
VEGRRE259	7518204 - A6421400160 - A6421400860 - A6421400360 - 6421400160 - 6421400860 - 6421400360	88204	
VEGRRE260	7518205 - 500322055 - 722768000 - 7350D	88205	2.8 D/Td da 62 a 64 Kw
VEGRRE261	7518206 - 6421401860 - 6421400460 - 7645D - AC5083330068 - A6421400460 - A6421401860	88206	3.0 Cdi da 140 a 165 Kw
VEGRRE262	1618KL - 1618NQ - 9M5Q9D475CA - 30725803 - 7518198	88198	1.6 Tdci da 70 a 85 Kw, 2.0 Hdi da 85 a 120 Kw
VEGRRE263	LR003830 - 6HQ9D475DD - LR006986 - LR009702 - LR013321 - 700420 - 7518197 - 700421	88197	3.6 Td 200 Kw
VEGRRE264	038131501N - 7518209	88209	1.9 Tdi 74 Kw
VEGRRE265	30774848 - 36000997 - 7518212	88212	2.4 Ds da 93 a 136 Kw
VEGRRE266	057131501C/D/E/F/G - 700789100 - 700789030 - 700789040 - 700789050 - 700789070 - 7518213	88213	4.2 Fsi / 4.2 v8 Tdi da 250 a 273 Kw
VEGRRE267	059131502B - 7518214	88214	2.7 Tdi da 120 a 140 Kw, 3.0 Tdi da 155 a 176 Kw
VEGRRE268	7518215 - 1685740 - AV6Q9D475AB - 1618LC - 6QAV9D475AB - 36001479 - 70215615 - 702156150 - 70215624 - 702156240	88215	1.6 Hdi da 55 a 82 Kw
VEGRRE269	03L115512A - 702756070 - 7518217 - 70257604 - 702756040 - 70275607	88217	2.0 BiTdi 132 Kw
VEGRRE270	36001487 - 7518216 - 702209110 - 702209040	88216	1.6 D 84 Kw
VEGRRE271	7518220 - 03L131512Q - VASV29010029 - 555106 - V29004490 - AEGR931	88220	2.0 BiTdi da 62 a 132 Kw
VEGRRE272	1701764 - BG9Q9Y456AC - 555117 - V29007078 - AEGR924	88221	2.2 Tdci da 129 a 147 Kw
VEGRRE273			
VEGRRE274			
VEGRRE275			
VEGRRE276	147105M30B		2.5 Ddti
VEGRRE277	147105M30B - 7518218	88218	
VEGRRE278	28410 - 2A850 - 284102A850		
VEGRRE279	8200222772 - 93161826 - 4431702 - H8200222772		2.5 Dci da 88 a 107 Kw
VEGRRE280	03P131512D		1.2
VEGRRE281	2580026010 - DEG0104		2.0 D-4D da 68 a 95 Kw
VEGRRE282			
VEGRRE283	A6480900154		3.0 Cdi 130 Kw

COD.	CODICE OEM	MEAT	APPLICAZIONI
VEGRRE284			

NOTE

Area for notes with horizontal dashed lines.

Fiat, Lancia

7755857



CFR01

Fiat

7768179



CFR02

Fiat, Lancia

7712842



CFR03

Alfa, Lancia

60629627 - 60815477



CFR04

Fiat

46533515



CFR05

Fiat

46526640



CFR06

Gruppo Fiat

60816029 - 60815340



CFR07

Gruppo Fiat

77363298 - 46781326



CFR08

Fiat

77363297 - 46781327



CFR09

Fiat

71737116 - 71740011



CFR10

Fiat

71732618



CFR11

Fiat

71732365 - 71730302



CFR12

Alfa Romeo

77363353 - 60654043



CFR13

Fiat, Lancia

77363462



CFR14

Alfa Romeo

77363751 - 55194138



CFR15

Fiat, Lancia

467559890 - 46807151



CFR16

Gruppo Fiat

46817372 - 46817373



CFR17

Smart

0003094V0004 - 0003094V0006



CFR18

Innocenti



CFR19

Opel

98105208



CFR20

Mercedes

1661410225



CFR21

Audi, Volkswagen

038128063M - 038128063P



CFR22

Alfa, Opel, Saab

55199971 - 55196350



CFR23

BMW

11717804384 - 7791481



CFR24

Gruppo Volkswagen

06A133062A



CFR25

Gruppo Volkswagen

030133064D



CFR26

Gruppo VW, Opel

045128063G - V110



CFR27

Seat, Skoda

036133062B - 036133062N



CFR28

Mercedes

A64020900070



CFR29

Gruppo Fiat

55222912 - 46823851



CFR30

Gruppo VW, Opel

045128063G - 045128063D



CFR31

Gruppo Fiat

46823851



CFR32

Gruppo Fiat

55192786



 **CFR33**

Daewoo



 **CFR34**

Renault

8200284968 / 8200568712C



 **CFR35**

Alfa Romeo

0132008650 / 3435201458



 **CFR36**

Opel

937731292 - 5825253



 **CFR37**

Renault

8200067219 - 7701051585



 **CFR38**

Peugeot

9647925480



 **CFR39**

Gruppo Volkswagen

03G128063C - 03G128063J



 **CFR40**

Maserati

58106038 - 41417038-06



 **CFR41**

Opel

0280750133



 **CFR42**

Renault

8200096038 - 7700115834



 **CFR43**

Smart

MN149259



 **CFR44**

BMW

1354750904302



 **CFR45**

Smart



 **CFR46**

Toyota



 **CFR47**

Renault

8200736114 - 7701062300



 **CFR48**

Opel



CFR49

Gruppo Volkswagen

045128063G - V120



CFR50

Audi, Volkswagen

059145950 - V130



CFR51

Ford

2S6U9E928BA - 2S6U9E927



CFR52

Nissan

1611944B00



CFR53

Audi, Volkswagen

4E0145950C - D - F - G - H



CFR54

Opel

008025243 - 9157512



CFR55

Gruppo Volkswagen

03G128063A - 03G128063G



CFR56

Citorën, Peugeot, Toyota

22030-0Q010-A - 59221



CFR57

Gruppo Volkswagen

06A133064J



CFR58

Chrysler

4777860AA



CFR59

Hyundai

35100-4X400



CFR60

Opel

817158 - 9192122



CFR61

Renault

7700108120 - 8200077623



FRC62

Gruppo Volkswagen

03G128063B - K - L - R



CFR63

Citroën, Peugeot

1635Q9 - 9635884080



CFR64

Renault, Suzuki

3400-67JG0



 **CFR65**

Gruppo Volkswagen

059128063A



 **CFR66**

Seat, Volkswagen

037133064D



 **CFR67**

Gruppo Volkswagen

06A133064M



 **CFR68**

Audi, Skoda, VW

06A133063F



 **CFR69**

Audi, Volkswagen

058133063H



 **CFR70**

Audi, Volkswagen

036133064E



 **CFR71**

Nissan

161190U400



 **CFR72**

Nissan

1611972B60



 **CFR73**

Nissan

1611941B02



 **CFR74**

Nissan

161190U000



 **CFR75**

Nissan

1611972B00



 **CFR76**

Audi, Volkswagen

06A133066



 **CFR77**

Audi, Volkswagen

37133064



 **CFR78**

Audi, Volkswagen

06A133063G



 **CFR79**

Audi, Volkswagen

058133063Q



 **CFR80**

Volkswagen

036133064D



 **CFR81**

Audi, Volkswagen

06A133066E



 **CFR82**

Audi, Volkswagen

06A133064H



 **CFR83**

Mercedes Benz

1419125 - 0011410525



 **CFR84**

Renault

8200063652 - 8200123061



 **CFR85**

Audi, Volkswagen

037133064A



 **CFR86**

Audi, Volkswagen

036133062M



 **CFR87**

Opel

825233 - 825248 - 9128518



 **CFR88**

Opel

12583274 - 24459501 - 253



 **CFR89**

Opel

825469 - 90536084 - 90543



 **CFR90**

Skoda

047133061 - 5WP4270



 **CFR91**

Jeep, Volkswagen

038128063J - 038128063A



 **CFR92**

Gruppo Fiat

60672311 - 60816181



 **CFR93**

Audi, Volkswagen

047133062D



 **CFR94**

Audi, Volkswagen

036133062L



 **CFR95**

Daewoo



 **CFR96**

Citroën, Peugeot, Fiat

1635R8 - 9640796280



CFR97

Citroën, Peugeot, Fiat

1635V3 - 1635W8 - 965268



CFR98

Renault

8200171134 - 8200190230



CFR99

BMW

13540872457 - 13541496717
13547509043



CFR100

Audi, Volkswagen

03C133062B



CFR101

Audi, Volkswagen

03C133062C



CFR102

Audi, Volkswagen

03D133062E



CFR103

Nissan

06F133062E - 06F133062G



CFR104

Audi, Volkswagen

1110980009



CFR105

Gruppo Fiat

77363793



CFR106

Fiat

77363827



CFR107

Fiat

71718994 - 71736817



CFR108

Gruppo Fiat

71718989 - 77363331



CFR109

Seat, Skoda, VW

030133064F



CFR110

Audi, Volkswagen

036133064C - 037133064A



CFR111

Mercedes

A1131410125



CFR112

Audi, Volkswagen

03G128063 - V120



CFR113

Citroën, Peugeot

3437020592 - 438510
1920Y2



CFR114

Mitsubishi, Smart

MN149258



CFR115

Citroën, Peugeot

9650787380 - 1635X0



CFR116

Nissan, Renault

8200302798F



CFR117

Volvo

8692720



CFR118

Mercedes

A1111410325



CFR119

Audi, Volkswagen

06B133062D



CFR120

BMW

13541439224



CFR121

BMW

13541433414



CFR122

BMW

13547502444 - 135475024



CFR123

BMW

13547506627



CFR124

Lancia, Fiat

AFH60M15 - RMH6001



CFR125

Suzuki

1340064G01



CFR126

Mercedes

0001419525



CFR127

Mercedes

0001416525 - 0001419625



CFR128

Seat, Volkswagen

047133061G



 **CFR129**

Mini

13541503358



 **CFR130**

Mercedes

1111410025



 **CFR131**

Citroën, Peugeot

6630694A0



 **CFR132**

Audi, Skoda, VW

03L128063A - B - C - D - E



 **CFR133**

Fiat

0438201041 - 3435201535



 **CFR134**

Ford

8A6G-9F991-AB



 **CFR135**

Audi, Volkswagen

077133062A



 **CFR136**

Audi, Volkswagen

036133062D



 **CFR137**

Audi, Volkswagen

077133062A



 **CFR138**

Citroën, Peugeot

7276635000



 **CFR139**

Renault

8200330810E



 **CFR140**

Opel



 **CFR141**

Fiat



 **CFR142**

Porsche

98660511501



 **CFR143**

Mercedes

A2711410025



 **CFR144**

Audi

078133062B



 **CFR145**



 **CFR146**

Audi, Volkswagen

06A133064B



 **CFR147**

26J231508 - 0280750095



 **CFR148**

Fiat

280750229



 **CFR149**

Nissan



 **CFR150**

Renault



 **CFR151**

Porsche, Volkswagen

06B133062B - 99660511500



 **CFR152**

Opel



 **CFR153**

Renault

H873633-067A1



 **CFR154**

Audi, Volkswagen

06B133062E - 0280750080



 **CFR155**

Fiat

77364870



 **CFR156**

Citroën, Peugeot

9684269380



 **CFR157**

Audi, Volkswagen

03L128063E



 **CFR158**

Audi, Volkswagen

057128063B/C/D



 **CFR159**

Citroën, Peugeot

9685879480 - 163667



 **CFR160**

Mitsubishi

29090443 - MD628227 - MN153347



CFR162

Citroën, Mini

13547579697 - 163636 -
A2C59513207



CFR164



CFR161



CFR163

Citroën, Mini

13547576698 - 163631 -
A2C59513208



CFR165

BMW

13547556119 - 13547597885 -
A2C59513206



CFR166

Volkswagen

06A133064P



CFR167

Volkswagen

037133064J



CFR168

Renault

8200503217



CFR169

Citroën, Ford, Land Rover

9687888280 - 1427361 - LR012598



CFR170

Opel

5825257 - 825265 - 97376266



CFR171

Renault, Nissan

1611800Q0H - 8200570865



CFR172

Opel

5825227 - 93171626



CFR173



CFR174



CFR174

Nissan

SERA576-02 - RME45



CFR176

BMW

13547502445



CFR177

Nissan

SERA576-01



CFR178

Smart

4000278060242



CFR179

Mercedes

A6460900870 - A2C53090824



CFR180

Dacia, Fiat

8200614985



CFR181

Mercedes

A64020900070



CFR182



CFR183

Citroën, Peugeot

1635Q4 - 9636215180



CFR184

BMW

408238424002 - 13547102445



CFR185

Ford

1516716 - 1519126 - A2C59513627



CFR186



CFR183

Citroën, Peugeot

163615 - 9653289480 - 802001985303



CFR188

Gruppo Volkswagen

06B133062P - 408238223003Z



CFR189

Gruppo Volkswagen

06B133062L - 408238323006Z



CFR190

Hyundai, Kia

3510027410 - 5WY9110C



CFR191

Gruppo Volkswagen

06F133062B - 408242002003Z



CFR192



Citroën, Ford, Peugeot, Volvo

9673534480



CFR209

Opel

50569200 - 55564164



CFR210

Audi, Volkswagen

06F133062



CFR211

Mazda

LFE213640



CFR212

Gruppo Volkswagen

03L128063Q



CFR213

Daihatsu, Subaru, Toyota

142008N20 - 22030-47010



CFR214

Nissan, Renault

RME50-1608196S



CFR215

BMW

13547566243-02



CFR216

BMW

780437301 - B81400545



CFR217

Gruppo Volkswagen

036133062Q - 408238323010Z



CFR218

Gruppo Volkswagen

06F133062 - 408238327003Z



CFR219

Hyundai, Kia

35100-2B000



CFR220

Opel

55195014



CFR221

Citroën, Fiat, Lancia, Peugeot

1340064G01



CFR222

Fiat, Opel

55564247



CFR223

Toyota

89452-30150



CFR224

Opel

0205003050 - 90329471 -
5825214



CFR225

Ford

VP4M5U-9E927-DC



CFR226

Ford

VP4M5U-9E927-DC



CFR227

Fiat

50SMG1 - 55354610



CFR228

Volkswagen

07Z128070G



CFR229

Fiat, Iveco

54DTE3I - 504385629



CFR230

Chevrolet, Opel

05562270 - 0280750482



CFR231

Mercedes

A6460900970 - 0280750230



CFR232

Fiat, Suzuki

8H24-5150 - 2J06515179J002J05



CFR233

Ford

7S7G-9F991-BA - 0280750534



CFR234

Opel

055559227 - RME50-301



CFR235

Mercedes

A1110980109 - 0280750045 -
0280750467



CFR236

Chevrolet, Opel

96440414 - 4803544 -
701060060



CFR237

Opel

96955300 - 5WY9180A -
701062060



CFR238

Citroën

9000073677 - 964951008000
- 0280750164



CFR239

Audi, Skoda, VW

03F133062



CFR240

Alfa Romeo

COD.	CODICE OEM	MEAT	APPLICAZIONI
CFR04	60629627 - 60815477 - 0280750014		2.5 - 3.0 - 3.2 da 140 a 184 Kw
CFR13	77363353 - 60654043 - 1287213611 - 0280750073 - 504335924 - 60654946		1.6 16v 77Kw, 1.6 16v 88 Kw
CFR14	77363462 - 88069750137 - F01C600027	89069R	1.4 16v 58 Kw
CFR15	77363751 - 55194138 - F01C600050		1.9 8v 118 Kw, 2.2 8v 136 Kw
CFR17	46817372 - 46817373 - 46791356 - 46767695 - 46769692 - 53228928 - 714400050 - 55222587 - 71793582		2.4 jtd 100 Kw, 1.9 jtd 110 Kw, 1.6 16v 88 Kw
CFR23	55199971 - 55196350 - 5828246 - 48CPD4 - 88106 - 7519106	89106	1.9 D Mjet 110 Kw
CFR32	46823851 - 552020830 - 55222911 - 714431020 - 71443105 - 714431050		1.9 Jtd 16v 103 Kw, 1.9 Jtd Q4 110 Kw, 2.4 Jtd 110/129 Kw
CFR36	132008650 - 3435201458 - 0280750023 - 0132008650 - 7514009 - 71713829 - 60816329 - 3437010455		1.4 16v 76/106 Kw, 1.8 16v 106 Kw, 2.0 ts 16v 110 Kw
CFR93	6067231 - 60816181 - 2438100 - 9454805 - 0371330647519040 - 88040 - 0280750102	89040	1.9 Jtd 66/68/77 Kw
CFR163	48CPD8 - 802007824803 - 55200822 - 7519077 - 71789279	89077	1.9 Jtd 85/88 Kw

Audi

COD.	CODICE OEM	MEAT	APPLICAZIONI
CFR22	038128063F - 038128063M - 71439316 - 714393260 - 714393160 - 88031 - 71439310 - 714393220 - CV1018812B1 - 7519031	89031	1.9 Sdi 47/50 kw, 1.9 Tdi 77 Kw, 2.0 Tdi 100 Kw
CFRE25	7519030-06A - 133062A06A - 133062B-06A - 133062AN - 7519030 - V10810004 - 40823832011Z - 408238323005Z	89030	1.6 B 75 Kw
CFR27	7519056 - 045128063G/D - 7519056 - A2C59511707 - A2C53096212	89056	1.4 D da 55 a 66 Kw
CFR28	7519043 - 036133062B/036133062N - 408238211007Z - 408238321003Z		1.4 Tdi 66 Kw
CFR31	7519056 - 045128063G - 04512806D - A2C59511707 - A2C53096212	89056	1.4 Tdi 66 Kw
CFR40	03G128063C - 03G128063J - 88054 - 216058682 - 03G128063A - 7519054 - A2V59511698 - V10810024 - A2C53099815 - 03G128061A - 03L128063L	89054	1.9 Tdi 85 Kw, 2.0 Tdi 100/103 Kw
CFR50	045128063G - 045128063D - 7519056	89056	1.4 D da 55 a 66 Kw
CFR51	059145950 - ACM069 - 059145950D - 7519076 - 059145950H - 10810026	89076	2.7 Tdi 120/132 Kw, 3.0 Tdi 155/165/171 Kw
CFR54	4E0145950C/D/G/F/H		2.7 Tdi 120/132/140 Kw, 3.0 Tdi 155/165 Kw, 3.0 Tdi 171/176 Kw
CFR56	03G128063A - 03G128063Q - 03G128063G - 03G128063M - ACM073 - 7519055 - 88055 - A2V59511699 - A2C59512934	89055	1.9 Tdi 77 Kw, 2.0 Tdi 103 Kw
CFR58	06A133064J - 06A133064K - 88011 - 70370307 - 06A133064M - 4082371110122	89011	1.6 B 74 Kw, 1.8 B 92 Kw
CFR63	03G128063B/K/L/R - 70068804 - 88086 - 700688060	89086	2.0 Tdi 125 Kw
CFR66	059128063A/B/D/E - 7519071 - ACM070 - 88071 - A2C5912937	89071	2.5 Tdi 120/132 Kw
CFR68	06A133064M - 7519006 - 7519011 - 10810003 - 408237111012Z - 408237111013	89006	1.8 20v 92 Kw
CFR69	06A133063F - 88007 - 7519007 - 408236212004Z	89007	1.8 T 110 Kw
CFR70	057133063H - 88008 - 7519008 - V10810008 - 4082372120022 - 009Z	89008	1.6 74 Kw, 1.8 85/92 Kw
CFR77	06A133066 - ACM080 - 7519017 - 88017 - 4082361110052 - 37133064	89017	1.6 16v 74 Kw
CFR78	06A133066 - ACM080 - 7519017 - 88017 - 4082361110052 - 37133064	89017	1.6 16v 74 Kw
CFR79	06A133063G - 88019 - 408237212007 - 408237212007 - 408237212007Z	89019	1.8 T 110 Kw

Audi

COD.	CODICE OEM	MEAT	APPLICAZIONI
CFR80	058133063Q - ACM020 - 408237212008 - 7519020 - 408237212008Z	89020	1.8 T 110/132 Kw
CFR95	036133062L - 7519042 - 88042 - 10810013 - 408238321003 - 036133062N	89042	1.4 16 v 55 Kw
CFR102	06F133062E/Q/G - 88052 - 7519052 - A2C59511705	89052	1.8 Tsi 88/118 Kw, 2.0 Tfsi da 125 a 200 Kw
CFR104	06F133062E/Q/G - 88052 - 7519052 - A2C59511705	89052	1.8 Tsi 88/118 Kw, 2.0 Tfsi da 125 a 200 Kw
CFR113	03G128063C - 03G128063J - 88054 - 216058682 - 03G128063A - 7519054 - A2V59511698 - V10810024 - A2C53099815 - 03G128061A - 03L128063L	89054	1.9 Tdi 85 Kw, 2.0 Tdi 100/103 Kw
CFR120	06B13306D/P - ACM029 - 408238223003		1.6 75 Kw
CFR133	03L128063A/B/C/D/E - 88073 - 7519073	89073	2.0 Tdi 16v da 81 a 125 Kw
CFR136	077133062A - 0280750047		4.2 v8 Fsi4 273 Kw
CFR137	036133063C - 036133062D - 0280750059		1.6 Fsi 81 Kw
CFR138	077133062A - 0280750047		4.2 v8 Fsi4 273 Kw
CFR148	078133062B - 0280750030 - 078133062A/J		2.8 v6 142 Kw, 2.4 v6 da 100 a 125 Kw, 3.0 162 Kw
CFR152	068133062B/P/M - 99660511500 - 0280750009		1.8 T 20v 110/125/140 Kw
CFR155	06B133062E - 0280750080		1.8 92 Kw
CFR158	03L128063A/B/C/D/E - 7519073 - 88073	89073	2.0 Tdi da 88 a 125 Kw
CFR159	057128063B - 057128063D - 88075 - 7519075	89075	4.2 Tdi 235/240 Kw
CFR189	06B133062P - ACM029 - 06B133062D - 4082382230032 - 408238223003		1.6 75 Kw
CFR190	06B133062L - 40828323006 - 408238320062 - ACM093		1.6 74 KW
CFR192	06F133062B - 4082420020032 - 06F133062S		2.0 Fsi 110 Kw
CFR199	03G128063C - 03G128063J - 88054 - 216058682 - 03G128063A - 7519054 - A2V59511698 - V10810024 - A2C53099815 - 03G128061A - 03L128063L	89054	1.9 Tdi 85 Kw, 2.0 Tdi 100/103 Kw
CFR211	06F133062 - ACM068 - 408238327003Z - 408238327003		2.0 Fsi 110 Kw

BMW

COD.	CODICE OEM	MEAT	APPLICAZIONI
CFR24	7519039 - 11717804384 - 7791481 - 11717791481 - 7804384 - 700376020 - 700376040 - 7519039 - 70037604	89039	2.0 D da 90 a 130 Kw, 3.0 D da 130 a 200 Kw
CFR45	1354750904302 - 408238623002		1.6 66 Kw, 1.6 125 Kw
CFR121	13541439224 - 13541435959 - 13541741671 - V208100001 - 408238422003Z		1.6 85/90 Kw, 1.8 85 Kw, 2.0 90/95/105/110 Kw
CFR122	13541433414 - 13541433385 - 1433414 - 143341405 - 007623101 - 8UK007623007/...101		2.0 i 110 Kw, 2.5 i 125 Kw, 2.8 i 142 Kw
CFR123	13547502444 - 13547502445 - 21693 - 2021693 - V20810003 - 408238425001 - ...004Z		2.0 i 125 Kw, 2.2 i 125 Kw, 2.5 i 141 Kw
CFR124	13547506627 - 7519053 - 88053 - A2C59511706	89053	3.5 i 200 Kw, 4.4 i 210/235 Kw, 4.5 i 245 Kw, 4.8 i 265 Kw
CFR166	13547556119 - 13547597885 - A2C59513 - 88101 - 7519101 - A2C59513206	89101	3.0 220/225/240 Kw
CFR177	13547502455 - 408238424001 - 408238424002Z - V20810002		3.0 i 163/170 Kw
CFR185	408238424002 - 13547102445 - ACM094 - 7502445		3.0 170 Kw
CFR216	13547566243 - 13547563377 - 07119903863		
CFR217	780437301 - B81400545		2.0 D da 90 a 130 Kw

Chryslers

COD.	CODICE OEM	MEAT	APPLICAZIONI
CFR59	4777860AA - 408238426003		1.6 D 85 Kw

Citroën

COD.	CODICE OEM	MEAT	APPLICAZIONI
CFR39	9647925480 - 50SMP1 - 1635W2 - 88105 - 7519107 - 802001500013	89107	1.4 16v 65 Kw
CFR64	1635Q9 - 9635884080 - 0280750085 - 447280		1.6 16v 80 Kw, 16 Vts 90 Kw
CFR97	1635R8 - 9640796280 - ACM034 - 88045 - 7519045	89045	1.4 i 54/55 Kw
CFR98	7519046 - 88046 - 9652682880 - 1635V3 - 1635W8 - 96448053780 - 408239823003	89046	1.8 16v 85Kw, 2.0 16v 100 Kw
CFR114	3437020592 - 0986438510 - 1920Y2		1.1 i 44 Kw, 1.4 Gt 55/59 Kw
CFR116	9650787380 - 1635X0 - ACM103 - 408239827001Z		1.8 92 Kw, 2.0 104 Kw
CFR132	6630964A0		
CFR139	727663500 - PSA642A01		1.4 L 55 Kw
CFR157	9684269380 - 50CDDP9 - 802009289501 - 0345F0 - 7519070	89070	2.0 Hdi 100 Kw
CFR160	9685879480 - 13667 - 7519110 - 88110 - 44GTE3P	89110	1.4 Vts 70 kw
CFR164	A2C59513207 - 13547557222 - 13547574379 - 13547576697 - 163636 - V74766978		1.4 16v 65/70 Kw, 1.6 16v da 80 a 110 Kw, 1.8 16v 90 Kw, 2.0 16v 100/103/130 Kw
CFR170	9687888280 - 1427361 - LR012598 - 9656932580 - 9687888280 - 1427361		2.2 Hdi 115/125 Kw
CFR184	1635Q4 - 9636215180 - 60CPM1 - 802001183909 - 7519111	89111	2.0 Hdi 16v 108 Kw
CFR188	1635N0 - 9653289480 - 7519109 - 60CPM2 - 88092	89109	2.2 Hdi 116 Kw
CFR197	0345G7 - 556085 - V29007928		
CFR209	967353440 - 28275019 - W296037		1.6 Hdi 81 Kw

Daewoo

COD.	CODICE OEM	MEAT	APPLICAZIONI
CFR34			
CFR96			

Fiat

COD.	CODICE OEM	MEAT	APPLICAZIONI
CFR01	7755857 - 71787492		1.2 16v 44 Kw
CFR02	7768179		
CFR03	7712842		
CFR05	46533515 - 47290083 - 0280750042 - 0280750014 - 0280750101 - 60629627 - 60672311 - 308816181	89027	1.2 16v 59 Kw
CFR06	46526640 - 46425923 - 71787532 - 007623161 - 7519064	89064	1.2 16v 63 Kw
CFR07	60816029 - 60815340 - 46466172 - 0205003052		2.0 20v 110/113 Kw, 2.4 20v 125 Kw

Fiat

COD.	CODICE OEM	MEAT	APPLICAZIONI
CFR08	77363298 - 46781326 - 71718959 - 467881326 - 365XFE - 36SWFE1 - 802001291204 - 802000135403 - 36SXF102 - 88001 - 7519001	89001	1.1 Mpi 40 Kw, 1.2 Mpi 44 Kw
CFR09	77363297 - 46781327 - 71787557 - 7519065 - 36SXF5 - 802001301004	89065	1.2 44 Kw, 1.2 54 Kw
CFR10	71737116 - 71740011 - 802007715701 - 46SXF8 - 71718821 - 8UK007623141 - 71787563	89044	1.6 16v 66 Kw, 1.6 16v 76 Kw
CFR11	71732618 - 802001783002 - 36SMF6 - 88058 - 77365316 - 7519058 - 71787569 - 802001783002	89058	1.2 Mpi 44 Kw, 1.2 4x4 44 Kw
CFR12	71732365 - 71730302 - 48SMFSA - 71719143 - 88061 - 806001680202 - 7519061 - 71732365 - 48SMF5A	89061	1.6 16v 76 Kw
CFR14	77363462 - 750137 - F01C600027 - 88069	89069R	1.4 Mpi 66 Kw, 1.4 16v 70 Kw
CFR16	467559890 - 46807151 - 467559889 - 46755989 - 71437800 - 71437800 - 714378080 - 71437806 - 714378060 - ACM056 - 46807152 - 4675598		1.9 Jtd 59/63 Kw, 1.9 Jtd 66 Kw
CFR17	46817372 - 46817373 - 53228928 - 46791356 - 714400050 - 55222587		1.4 Mpi 55 Kw
CFR23	55199971 - 55196350 - 5828246 - 48CPD4 - 7519106 - 88106	89106	1.9 D Mjet 110 Kw
CFR30	55222912 - 46823851 - 250852 - 55200820 - 71794618 - 802009196601 - 48CPD6 - 88084 - 7519084	89084	1.9 D Mjet 110 Kw
CFR174	55222912 - 46823851 - 250852 - 55200820 - 71794618 - 802009196601 - 48CPD6 - 88084 - 7519084	89084	1.9 D Mjet 110 Kw
CFR175	55222912 - 46823851 - 250852 - 55200820 - 71794618 - 802009196601 - 48CPD6 - 88084 - 7519084	89084	1.9 D Mjet 110 Kw
CFR32	46823851 - 552020830 - 55222911 - 714431020 - 71443105 - 714431050		1.9 Jtd 16 v 103 Kw
CFR33	77363827 - 55192786 - 0415288 - 28475 - 52003180 - 6146100007 - G3987 - 2256032	89060	1.2 48 Kw, 1.2 51 Kw
CFR36	132008650 - 3435201458 - 0280750013 - 0280750023 - 0132008650 - 7514009 - 7173829 - 60816329 - 3437010455	89009	1.4 8/12v 59 Kw, 1.2 16v 60 Kw
CFR37	937731292 - 5825253 - ACM102 - 55199974 - 93186494 - 48CPD1 - 0825310 - 13400/79J50 - 5825245 - 58282469317062 - 7519074 - 88074	89074	1.9 D Mjet 88 Kw, 1.9 D Mjet 96 Kw
CFR93	6067231 - 60816181 - 2438100 - 9454805 - 0391330647519040 - 88040 - 0280750102	89040	1.9 Jtd 105 77 Kw
CFR97	1635R8 - 9640796280 - ACM034 - 88045 - 7519045	89045	1.4 i 54/55 Kw
CFR98	7519046 - 88046 - 9652682880 - 1635V3 - 1635W8 - 9648053780 - 408239823003	89046	2.0 16v 100 Kw
CFR106	7519059 - 77363793 - 88059 - 007623181 - 44SMF91 - 71787548 - 802001957505	89059	1.4 51/57 Kw
CFR107	77363827 - 0415288 - 28475 - 7519060 - 88060 - 52003108 - 6147100007 - G33987 - 2256032	89060	1.2 8v 48/51 Kw
CFR108	7178994 - 71736817 - 7519062 - 88062 - 46SXF7 - AT1002212B1 - 802007638901	89062	1.6 16v 74/78 Kw
CFR125	AFH60M15 - RMH6001		1.8 16v 96 Kw
CFR134	0438201024 - 0123008600 - 0986438660 - 7565845 - 7613370 - 7762696 - 0438201041		1.5 ie 55 Kw, 1.6 ie 60 Kw
CFR142			
CFR149	0280750029 - F01C600066 - 77364143 - 7519113	89113	1.4 16v 70/74 Kw
CFR156	77364870 - 88067 - 7519067 - 44SMF9	89067	1.4 57/88 Kw
CFR163	48CPD8 - 802007824803 - 55200822 - 7519077 - 71789279	89077	1.9 Jtd 85 Kw
CFR206	55213019 - 199A9000		1.3 Mjet euro 5 70Kw

Ford

COD.	CODICE OEM	MEAT	APPLICAZIONI
CFR52	256U9E9288A - 256U9E927C - L665826		1.4 i duratec 66 Kw

COD.	CODICE OEM	MEAT	APPLICAZIONI
CFR135	8A669F991AB - 078133062B - 0280750478 - 1538498 - 8A6GAB		
CFR139	727663500 - PSA642A01		1.4 L 55 Kw
CFR170	9687888280 - 1427361 - LR012598 - 9656932580 - 9687888280 - 1427361		2.2 Tdci 114 Kw
CFR186	1516716 - 1519126 - A2C59513627 - ACM116 - 07VQ9E926AA - 07VQ9E926AB		1.6 Tdci 55/66/80 Kw
CFR205	7V2Q9E926AB - 1516716 - 1519126 - 41035900944023 - 7V2Q9E926AA		1.6 Tdci 80 Kw
CFR209	967353440 - 28275019 - W296037		1.6 Hdi 81 Kw

Hyundai

COD.	CODICE OEM	MEAT	APPLICAZIONI
CFR60	351004X400 - 3510027410 - 3510027400 - 5WY9110C	89122	2.0 Crdi 85/103 Kw, 2.2 Crdi 110 Kw
CFR191	351004X400 - 3510027410 - 3510027400 - 5WY9110C	89122	2.0 Crdi 85/103 Kw, 2.2 Crdi 110 Kw
CFR203	35100/2A900 - W745668		1.6 Crd 6vxl 85 Kw

Innocenti

COD.	CODICE OEM	MEAT	APPLICAZIONI
CFR19			1.0
CFR134	0438201024 - 0123008660 - 7565845 - 7613370 - 7762696 - 043820141		1.5 ie 55 Kw, 1.6 ie 60 Kw

Jeep

COD.	CODICE OEM	MEAT	APPLICAZIONI
CFR92	038128063A/J/C - 39002015F - 88038 - 7519038 - 71430900 - 714309150 - CV101841281	89038	2.8 Crd 110/120 Kw

Kia

COD.	CODICE OEM	MEAT	APPLICAZIONI
CFR60	351004X400 - 3510027410 - 3510027400 - 5WY9110C	89122	2.0 Crdi 85/103 Kw, 2.2 Crdi 110 Kw
CFR191	351004X400 - 3510027410 - 3510027400 - 5WY9110C	89122	2.0 Crdi 85/103 Kw, 2.2 Crdi 110 Kw
CFR203	35100/2A900 - W745658		1.6 Crd 6vxl 85 Kw

Lancia

COD.	CODICE OEM	MEAT	APPLICAZIONI
CFR01	7755857 - 71787492		1.2 16v 44 Kw
CFR03	7712842		
CFR04	60629627 - 60815477 - 0280750014		2.4 v6 24v 125 Kw
CFR05	46533515 - 46533515 - 7519027 - 0280750042	89027	1.2 16v 59 Kw
CFR06	46526640		1.2 16v 63 Kw
CFR07	60815340 - 46466175 - 60816029 - 0205003052		2.0 20 v 113 Kw, 2.0 turbo 136 Kw, 2.4 20 v 129 Kw

Lancia

COD.	CODICE OEM	MEAT	APPLICAZIONI
CFR08	77363298 - 7519001 - 802001291204 - 88001 - 46526286 - 71787554 - 36SXFE - 36SXFE1		1.2 Mpi 44 Kw
CFR10	211541000304 - 71787563 - 71740011 - 46799832 - 46531929 - 802007715701 - 46SXF8 - 46SXF2	89044	1.6 16v 66 Kw, 1.6 16v 76 Kw
CFR14	77363462 - 88069750137 - F01C600027	89069R	1.4 16v 70 Kw
CFR17	46817372 - 46817373 - 53228928 - 46769691 - 714400050 - 55222587 - 71793582		1.6 16v 75 Kw, 2.4 20v 125 Kw
CFR32	56823851 - 552020830 - 55222911 - 714431020 - 71443105 - 714431050		2.4 Jtd 110 Kw
CFR98	7519046 - 88046 - 9652682880 - 1635V3 - 1635W8 - 9648053780 - 408239823003	89046	2.0 16v 100 Kw
CFR106	7519059 - 77363793 - 88059 - 007623181 - 44SMF91 - 71787548 - 802001957505	89059	1.4 57 Kw
CFR109	71718989 - 77363331 - 88063 - 7519063	89063	1.6 16v 76 Kw

Maserati

COD.	CODICE OEM	MEAT	APPLICAZIONI
CFR41	58106038 - 41417038 - 8644344 - 8644345 - 8644346 - 8644387 - 9186793 - 9451987 - 9497244 - AH0015008A/C - AH0013536A/B/C - AH0002030M - AH0012381C/E/A - AH0002030J/K/L - 65CFM2 - 65CFM9		4.2 32v 298 Kw
CFR126	1340064G01		

Mercedes Benz

COD.	CODICE OEM	MEAT	APPLICAZIONI
CFR21	1661410225 - 7519028 - 408238127002Z	89028	1.4 60 Kw, 1.6 75 Kw, 1.9 92 Kw
CFR29	A64020900070		
CFR84	1419125 - 0011410525 - ACM114 - 408227121003Z - A2C59510987		2.3 D 95/105 Kw
CFR105	1110980009 - 7519057 - 88057 - 408224001001	89057	2.0 Komp. da 132 a 141 Kw, 2.3 Komp. 142 Kw
CFR112	A1131410125 - A1131410126 - 0280750017		2.5 150 Kw, 3.0 170 Kw, 3.5 da 190 a 225 Kw, 4.3 205 Kw, 5.0 218 Kw, 5.5 260 Kw
CFR119	A1111410325 - 0280750074 - 30770137 - V30770137		1.8 90 Kw, 2.0 da 95 a 140 Kw, 2.3 da 105 a 142 Kw
CFR127	0001419525 - A0001419525 - ACM079 - 408229111001Z		1.8 90 Kw, 2.0 100 Kw, 2.3 100 Kw
CFR128	0001416525 - 0001419625 - ACM009 - 408227211001 - 408227211002/...002Z		2.8 142/145 Kw, 3.2 165/220 Kw, 3.6 200/206 Kw
CFR131	1111410025 - 0205003044 - A1111410025		2.0 K 137/141Kw, 2.3 k 142 Kw
CFR144	A2711410025 - 0280750076		1.8 B da 90 a 141 Kw
CFR180	A6460900870 - A2C53090824		2.2 Cdi da 65 a 110 Kw
CFR182	A64020900070		

Mazda

COD.	CODICE OEM	MEAT	APPLICAZIONI
CFR201	RF7J136B0 - RF7J13B0C - 001200384412H18		2.0 Cd 81/89/103/105 Kw

Mitsubishi

COD.	CODICE OEM	MEAT	APPLICAZIONI
CFR22	038128063L - 038128063Q - 038128063G - 038128063P - 038128063M - 71439316 - 714393260 - 714393160 - 88031 - 7519031	89031	2.0 Di-D 100 Kw, 2.0 Di-D 103 Kw
CFR44	MN149259 - MN149258 - A1341400004 - A1351400104		1.3 B 70 Kw
CFR115	MN149258		1.1 55 Kw
CFR146	038128063L - 038128063Q - 038128063G - 038128063P - 038128063M - 71439316 - 714393260 - 714393160 - 88031 - 7519031	89031	2.0 Di-D 100 Kw, 2.0 Di-D 103 Kw
CFR162	EAC60005 - 29090443 - MD628227 - MN153347 - MR507890		1.8 Gdi 88 Kw, 2.0 Gdi 95 Kw

Mini

COD.	CODICE OEM	MEAT	APPLICAZIONI
CFR45	1354750904302 - 408238623002		1.6 66 Kw, 1.6 125 Kw
CFR100	13540872457 - 1354196717 - 13547509043 - 7519048 - 88048 - 1496717 - 0872457	89048	1.6 66/85/88 Kw
CFR130	13541503358 - 408238627001Z		1.6 120/125/128 Kw
CFR165	A2C59513207 - 13547557222 - 13547574379 - 13547576697 - 163636 - V757669780		1.9 16v da 85 a 128 Kw, 1.6 Hdi 16v 80 Kw

Nissan

COD.	CODICE OEM	MEAT	APPLICAZIONI
CFR53	1611944800 - A81633 - FDM703 - 1611941B00 - 1611941B02 - 1611972B00 - 161190U000 - 161190U400 - MAFS015RBM		1.0 i 16v 40 Kw, 1.3 i 16v 55 Kw
CFR72	161190U400 - 7519012 - IDB811	89012	1.3 i 16v 55 Kw
CFR73	1611972860 - FDM703 - 1611944B00 - 1611972B00 - 191190U000 - 1914190U400 - MAFS015RBM		1.0 i 16v 40 Kw, 1.3 i 16v 55 Kw
CFR74	1611941B02 - 1611972860 - FDM703 - 1611944B00 - 1611972B00 - 191190U000 - 1914190U400 - MAFS015RBM		1.0 i 16v 40 Kw, 1.3 i 16v 55 Kw
CFR75	161190U000 - 7519015 - 88015	89015	1.0 i 16v 40 Kw
CFR76	1611972B00 - 1611972860 - FDM703 - 1611944B00 - 1611972B00 - 191190U000 - 1914190U400 - MAFS015RBM		1.0 i 16v 40 Kw, 1.3 i 16v 55 Kw
CFR117	8200302798F - 556082 - 269518114 - 8200302798 - 700416 - 23458 - 19053 - 18789 31546	89134	1.5 Dci da 63 a 78 Kw
CFR150			
CFR176	16119AX00C - SERA576/02 - RME45 - 007623231 - REM4501C		1.0 48 Kw, 1.2 48/59 Kw, 1.4 16v 65 Kw
CFR178	SERA576/01		1.4 L, 1.6 L, 2.0 L, 2.3 L
C215	RME50-18		

Opel

COD.	CODICE OEM	MEAT	APPLICAZIONI
CFR20	98105208 - 97300231 - 7519037 - 8973002311 - 8252669810528 - 8973002310 - 5825236 - 8981052080 - 700160020 - 70016002	89037	1.7 Td 50 Kw, 1.7 Dti 16 v 55 Kw, 1.7 Cdti 74 Kw
CFR42	0280750133 - 24420536 - 93181025 - 5825242		1.0 12v, 1.2 16v Twinport, 1.4 16v 66 Kw
CFR49			
CFR55	008025243 - 9157512 - 0280750044		1.0 12v 43/53 Kw, 1.2 16v 55 Kw

Opel

COD.	CODICE OEM	MEAT	APPLICAZIONI
CFR61	817158 - 9192122 - 88032 - 09192122 - 714319000 - 714319020 - 817158 - 25177983 - 25177983 - 714319075 - 714319050 - 714319080	89032	1.4 16v 66 Kw, 1.6 16v 62/69/71/74 Kw
CFR88	825233 - 825248 - 9128158 - 9196357 - 714319090 - 09128518 - 5WS91703 - 1008250248 - 08255248 - 93185000 - 714319550 - 714319570 - 714319580 - A2C59513664		1.8 16v 81/9091 Kw, 2.0 16v 106 Kw
CFR89	12583274 - 24459501 - 25312094 - 5825234 - 93174608 - 93176028 - 12791257	89034	2.2 i 16v 108 Kw
CFR90	825469 - 90536084 - 90543949 - 722334000 - 88035 - 7519035 - SWS932501	89035	1.8 i 16v 85 Kw
CFR141			
CFR153			
CFR171	98105208 - 97300231 - 7519037 - 8973002311 - 8252669810528 - 8973002310 - 5825236 - 8981052080 - 700160020 - 70016002	89037	1.7 Td 50 Kw, 1.7 Dti 16 v 55 Kw, 1.7 Cdti 74 Kw
CFR173	5825227 - 93171626 - 88072 - 71443900 - 71443903	89072	2.2 i D 110/114 Kw
CFR210	50569200 - 55564164 - 70181600 - 70181602 - 70181603 - 7018604 - 825611		

Peugeot

COD.	CODICE OEM	MEAT	APPLICAZIONI
CFR39	9647925480 - 50SMP1 - 1635W2 - 88105 - 7519107 - 802001500013	89107	1.4 16v 65 Kw
CFR64	1635Q9 - 9635884080 - 0280750085 - 447280		1.6 16v 80/82 Kw
CFR97	1635R8 - 9640796280 - ACM034 - 88045 - 7519045	89045	1.4 i 54/55 Kw
CFR98	7519046 - 88046 - 9652682880 - 1635V3 - 1635W8 - 9648053780 - 408239823003	89046	1.8 16v 85 Kw, 2.0 16v 100 Kw
CFR114	3437020592 - 0986438510 - 1920Y2		1.1 Cj 44 Kw, 1.4 Cj 55 Kw
CFR116	9650787380 - 1635X0 - ACM103 - 408239827001Z		1.8 92 Kw, 2.0 103 Kw
CFR132	6630694A0		
CFR157	9684269380 - 50CDDP9 - 802009289501 - 0345F0 - 7519070	89070	2.0 Hdi 100 Kw
CFR160	9685879480 - 13667 - 7519110 - 88110 - 44GTE3P	89110	1.4 16v 70 Kw
CFR164	A2C59513207 - 13547557222 - 13547574379 - 1354576697 - 163636 - V757669780		1.4 16v da 53 a 70 Kw, 1.6 16v da 80 a 128 Kw
CFR170	9687888280 - 1427361 - LR012598 - 9656932580 - 9687888280 - 1427361		2.2 Hdi da 115 a 125 Kw
CFR184	1635Q4 - 9636215180 - 60CPM1 - 802001183909 - 7519111	89111	2.0 Turbo 108 Kw
CFR188	1635N0 - 9653289480 - 7519109 - 60CPM2 - 88092	89109	2.2 16v 116/120 Kw
CFR200	163632 - 9653909680 - 7519108 - 88091	89108	2.2 16v 120 Kw

Porsche

COD.	CODICE OEM	MEAT	APPLICAZIONI
CFR143	98660511501 - 0280750007 - 98660611500 - 98660511500		2.7 162/168/176/180 Kw, 3.2 185/191/196/206/217 Kw, 3.6 309/331/340/355 Kw, 5.7 450Kw

Renault

COD.	CODICE OEM	MEAT	APPLICAZIONI
CFR35	8200284968 - 8200568712C - 8200503217 - 703703000 - H8200284968		1.2 i 16v 43Kw, 1.2 16v 55Kw

COD.	CODICE OEM	MEAT	APPLICAZIONI
CFR38	200067219 - 7701051585 - H8200067219 - 8200166869 - 8200067219 - 8200065648		1.2 16v 55 Kw
CFR43	8200096038 - 7700115834 - H7700115834 - 02004035 - 02085085		1.2 8v
CFR48	8200736114 - 7701062300 - ACM096 - 13541435959 - 408238426001 - 408238426003Z - A2C53107575 - A2C59512939 - V20810005		1.9 Dci 81 Kw, 1.9 Dci 96 Kw
CFR62	7700108120 - 8200077623 - 7701206378		1.2 Benz. 40/43 Kw
CFR65	13400/67JG0000 - 8200471660 - A2C53103391 - 587884		1.9 Dci 81/96 Kw
CFR85	8200063652 - 8200123061 - 7519025 - 88025 - 428239822001Z	89025	1.4 16v 72 Kw, 1.6 16v 70/79 Kw
CFR99	8200171134 - 8200190230 - 7519047 - 88047 - A2C59511232	89047	1.4 72 Kw, 1.6 16v 65/82/83 Kw
CFR117	8200302798F - 556082 - 269518114 - 8200302798 - 700416 - 23458 - 19053 - 18789 - 31546	89134	1.5 Dci da 63 a 78 Kw
CFR140	8200330810E - 0281002681 - 14175/00Q0 - 93161581 - H8200330812		2.0 Dci da 84 a 131 Kw
CFR151			
CFR154	H8783633 - 36XRR31 - 1014761199		1.2 43/44 Kw
CFR169	8200503217 - 88107 - 7519121 - 70370318 - 703703180	89121	1.2 16v da 40 a 56 Kw
CFR172	1611800Q0H - 8200570865 - 7519120 - 70370139	89120	1.2 16v 74 Kw
CFR181	8200614985 - 556081 - 88133 - 7519133 - 216057990	89133	1.5 Dci da 63 a 81 Kw
CFR194	8200754913 - 556084 - V29000345 - 70430	89135	1.9 Dci 96 Kw
CFR195	8200987453 - 556086 - V29005673		

Smart

COD.	CODICE OEM	MEAT	APPLICAZIONI
CFR18	0003094V0004 - 0006 - 0007 - A1601410225 - 0205003055		600 40 KW
CFR44	MN149259 - MN149258 - A1341400004 - A1351400104		1.3 Benzina 70 Kw
CFR46			1.5
CFR115	MN149258		1.1 55 Kw
CFR179	4000278060242		

Seat

COD.	CODICE OEM	MEAT	APPLICAZIONI
CFR22	038128063L - 038128063Q - 038128063G - 038128063P - 038128063F - 028128063M - 71439316 - 714393260 - 714393160 - 88031 - 71439310 - 714393220 - CV1018812B1 - 7519031	89031	1.9 Sdi 47/50 Kw, 1.9 Tdi 77 Kw, 2.0 Tdi 100 Kw
CFR25	7519030 - 06A133062A - 06A133062B - 06A133062AN - 7519030 - V10810004 - 408238323011Z - 408238323005Z	89030	1.6 Benzina 75 Kw
CFR26	7519003 - 030133064D - 408237130002Z - 3028ALT - V108100021	89003	1.0 i 37 Kw, 1.4 I 44 Kw
CFR27	7519056 - 045128063G/D - 7519056 - A2C59511707 - A2C53096212	89056	1.4 Tdi 51/59 Kw
CFR28	7519043 - 036133062B/N - 408238321007Z - 408238321003Z		1.4 Tdi 51/59 Kw
CFR31	7519056 - 045128063G - 04512806D - A2C59511707 - A2C53096212	89056	1.4 Tdi 51/59 Kw

Seat

COD.	CODICE OEM	MEAT	APPLICAZIONI
CFR40	03G128063C - 03G128063J - 88054 - 216058682 - 03G128063A - 7519054 - A2C59511698 - V10810024 - A2C53099815 - 03G128061A	89054	1.9 Tdi 77 Kw
CFR50	7519056 - 045128063G/D - 7519056 - A2C59511707 - A2C53096212	89056	1.4 Tdi 51/59 Kw
CFR56	03G128063A - 03G128063Q - 03G128063G - 03G128063M - ACM073 - 7519055 - 88055 - A2C5911699 - A2C59512934	89055	1.4 Tdi 59 Kw, 1.9 Tdi 66/74/77 Kw, 2.0 Tdi 103 Kw
CFR58	06A133064J - 06A11064K - 88011 - 70370307 - 06A133064M - 408237111012Z	89011	1.6 Benzina 74 Kw, 1.8 Benzina 92 Kw
CFR63	03G128063B/K/L/R - 70068804 - 88086 - 700688060	89086	2.0 Tdi 4x4 125 Kw
CFR67	037133064D - ACM001 - 7519005 - 88005 - 70370306 - 10810007 - 408237111008Z	89005	1.6 i Benzina 74 Kw
CFR68	06A133064M - 7519006 - 7519011 - 10810003 - 408237111012Z - 408237111013	89006	1.8 20v 92 Kw
CFR71	036133064E/J - ACM09 - 7519009 - 88009 - 408237111011Z	89009	1.4 i 16v 74 Kw
CFR77	06A133066 - ACM080 - 7519017 - 88017 - 408237111005Z	89017	1.6 16v 74/77 Kw
CFR86	03713364A/C - 70370312 - 88002 - 7519002	89002	1.4 i 16v 74 Kw
CFR87	036133062M - 7519029 - 88029 - ACM039 - 408238323008	89029	1.4 16v 74 Kw, 1.6 16v 77 Kw
CFR92	038128063A/J/C - 39002015F - 88038 - 7519038 - 71430900 - 71430900 - 714309150 - CV1018412B1	89038	1.9 Sdi 47/50 Kw
CFR95	036133062L - 7519042 - 88042 - 10610013 - 408238321003 - 036133062N	89042	1.2 16v 40/47 Kw, 1.4 16v 55 Kw
CFR101	03C133062B - 7519049 - 88049 - ACM060 - A2C59511702	89049	1.2 16v 47/51 Kw, 1.6 16v 55 Kw
CFR102	06F133062E/Q/G - 88052 - 7519052 - A2C59511705	89052	2.0 Tfsi da 147 a 195 Kw
CFR103	03D133062E - 88051 - 7519051 - ACM051	89051	1.2 16v 44 Kw
CFR104	06F133062E/Q/G - 88052 - 7519052 - A2C59511705	89052	2.0 Tfsi da 147 a 195 Kw
CFR110	030133064F - 7519004 - 133060001 - 88004 - 7519004 - 108100011 - 408237130004Z	89004	1.0 i 37 Kw, 1.4 i 44 Kw, 1.6 i 16v 55 Kw
CFR111	036133064A/C - 408237111003Z - 408237111001 - 88002 - 7519002	89002	1.4 16v 74 Kw
CFR113	03G128063C - 03G128063J - 88054 - 216058682 - 03G128063A - 7519054 - A2C59511698 - V10810024 - A2C53099815 - 03G128061A	89054	1.9 Tdi 77 Kw
CFR129	047133061G - ACM012 - 88012 - 10810022 - 408237430003 - 7519012	89012	1.0 37 Kw
CFR152	06B133062B/P/M - 99660511500 - 0280750009		1.8 T 20v 110 Kw
CFR167	06A133064P - 88103 - 703703150 - 10810020 - 408237111016Z		1.8 T 20v 110 Kw
CFR189	06B133062P - ACM029 - 06B133062D - 408238223003Z - 408238223003		1.6 75 Kw
CFR192	06F133062B - 4082420020032 - 06F133062S		2.0 Fsi 110 Kw
CFR211	06F133062 - ACM068 - 408238327003Z - 408238327003		2.0 Fsi 110 Kw

Skoda

COD.	CODICE OEM	MEAT	APPLICAZIONI
CFR22	038128063L - 038128063Q - 038128063G - 038128063P - 038128063F - 038128063M - 71439316 - 714393260 - 714393160 - 88031 - 71439310 - 714393220 - CV1018812B1 - 7519031	89031	1.9 Sdi 45/50 Kw, 1.9 Tdi 77 Kw, 2.0 Tdi 100 Kw
CFR25	7519030 - 06A133062A - 06A133062B - 06A133062AN - 7519030 - V10810004 - 408238323011Z - 408238323005Z	89030	1.6 Benzina 75 Kw
CFR26	7519003 - 030133064D - 408237130002Z - 3028ALT - V108100021	89003	1.0 i 37 Kw, 1.4 i 44 Kw, 1.6 i 55 Kw
CFR27	7519056 - 045128063G/D - 7519056 - A2C59511707 - A2C53096212	89056	1.4 Tdi 51/59 Kw

COD.	CODICE OEM	MEAT	APPLICAZIONI
CFR28	7519043 - 036133062B/N - 40828321007Z - 408238321003Z		1.4 Tdi 51/59 Kw
CFR31	7519056 - 045128063G - 04512806D - A2C59511707 - A2C53096212	89056	1.4 Tdi 51/59 Kw
CFR40	03G128063C - 03G128063J - 88054 - 216058682 - 03G128063A - 7519054 - A2C59511698 - V10810024 - A2C53099815 - 03G128061A	89054	2.0 Tdi 103 Kw
CFR50	7519056 - 045128063G/D - 7519056 - A2C59511707 - A2C53096212	89056	1.4 Tdi 51/59 Kw
CFR54	4E0145950C/D/F/G/H		2.0 Fsi 110 Kw
CFR56	03G128063A - 03G128063Q - 03G128063G - 03G128063M - ACM073 - 7519055 - 88055 - A2C59511699 - A2C59512934	89055	1.4 Tdi 59 Kw, 1.9 Tdi 4x4 77 Kw, 2.0 Tdi 4x4 103 Kw
CFR58	06A133064J - 06A133064K - 88011 - 70370307 - 06A133064M - 408237111012Z	89011	1.6 Benzina 74 Kw, 1.8 Benzina 92 Kw
CFR63	03G128063B/K/L/R - 70068804 - 88086 - 700688060	89086	2.0 Tdi Rs 125 Kw
CFR66	059128063A/B/D/E - 7519071 - ACM070 - 88071 - A2C5912937	89071	2.5 Tdi 120 Kw
CFR68	06A133064M - 75019006 - 7519011 - 10810003 - 408237111012Z - 408237111013	89006	1.8 20v 92 Kw
CFR69	06A133063F - 88007 - 7519007 - 408236212004Z	89007	1.8 T 110 Kw
CFR77	06A133066 - ACM080 - 7519017 - 88017 - 40823611105Z - 37133064	89017	1.6 16v 74 Kw
CFR78	06A133066 - ACM080 - 7519017 - 88017 - 40823611105Z - 37133064	89017	1.6 16v 74 Kw
CFR79	06A133063G - 88019 - 408237212007 - 4082372120072	89019	1.8 T 110 Kw
CFR82	06A133066E - 7519022 - 88022	89022	2.0 85 Kw
CFR83	06A133064H - 88023 - 40823111017 - 40823111017Z - 7519023	89023	2.0 85 Kw
CFR87	036133062M - 7519029 - 88029 - ACM039 - 408238323008	89029	1.4 16v 74 Kw
CFR91	5WP4270 - 88036 - 7519036 - 047133061 - 133077001 - 722456010 - V10810014	89036	1.3 Benzina 40/43/50 Kw
CFR92	038128063A/J/C - 39002015F - 88038 - 7519038 - 71430900 - 714309150 - CV1018412B1	89038	1.9 Sdi 47/50 Kw
CFR95	036133062L - 7519042 - 88042 - 10810013 - 408238321003 - 036133062N	89042	1.2 16v 40/47 Kw, 1.4 16v 55 Kw
CFR101	03C133062B - 7519049 - 88049 - ACM060 - A2C59511702	89049	1.2 16v 47/51 Kw, 1.6 16v 55 Kw
CFR102	06F133062E/Q/G - 88052 - 7519052 - A2C59511705	89052	1.8 Tsi 118 Kw, 2.0 Rs 147 Kw
CFR103	03D133062E - 88051 - 7519051 - ACM061	89051	1.2 16v 40/51 Kw
CFR104	06F133062E/Q/G - 88052 - 7519052 - A2C59511705	89052	1.8 Tsi 118 Kw, 2.0 Rs 147 Kw
CFR110	030133064F - 7519004 - 133060001 - 88004 - 7519004 - 108100011 - 408237130004Z	89004	1.6 i 16v 55Kw
CFR113	03G128063C - 03G128063J - 88054 - 216058682 - 03G128063A - 7519054 - A2C59511698 - V10810024 - A2C53099815 - 03G128061A	89054	2.0 Tdi 103 Kw
CFR133	03L128063A/B/C/D/E - 88073 - 7519073	89073	2.0 Tdi 16v da 81 a 125 Kw
CFR145	078133062B - 0280750030 - 078133062A/J		2.8 6v 142 Kw
CFR152	06B133062B/P/M - 99660511500 - 0280750009		1.8 T 20v 110 Kw
CFR158	03L128063A/B/C/D/E - 7519073 - 88073	89073	2.0 Tdi 125 Kw
CFR190	06B133062L - 408238323006 - 408238323006Z - ACM093		2.0 85 KW
CFR192	06F133062B - 4082420020032 - 06F133062S		2.0 Fsi 110 Kw
CFR211	06F133062 - ACM068 - 408238327003Z - 408238327003		2.0 Fsi 110 Kw

Suzuki

COD.	CODICE OEM	MEAT	APPLICAZIONI
CFR48	8200736114 - 7701062300 - ACM096 - 13541435959 - 408238426001 - 408238426003Z - A2C53107575 - A2C59512939 - V20810005		1.9 Ddis (Tdk) 95 Kw
CFR126	1340640064G01 - 1340064G01		

Toyota

COD.	CODICE OEM	MEAT	APPLICAZIONI
CFR47			
CFR57	22030 - 0Q010A - 59222 - 0280750192 - 0280750491		1.0 Vvt 5VX
CFR207	26100 - 0N030		1.4 D-4D 55/66 Kw
CFR208	26100/OR020 - 261000R020 - 1ADFTV		2.0 D-4D 91 Kw
CFR214	22030 - 47010		1.3 Vvt i

Volkswagen

COD.	CODICE OEM	MEAT	APPLICAZIONI
CFR22	038128063L/Q/G/P/F/M - 71439316 - 714393260 - 714393160 - 88031 - 71439310 - 714393220 - CV1018812B1 - 88031	89031	1.9 Sdi 47/50 Kw, 1.9 Tdi 77 Kw, 2.0 Tdi 100 Kw
CFR25	7519030 - 06A133062A - 06A133062B - 06A133062AN - 7519030 - V10810004 - 408238323011Z - 408238323005Z - 88030	89030	1.6 Benzina 75 Kw
CFR26	7519056 - 045128063G/D - 408237130002Z - 3028ALT - V108100021 - 88003	89003	1.0 37 KW, 1.4 44 KW, 1.6 55 KW
CFR27	7519056 - 045128063G/D - 7519056 - A2C59511707 - A2C53096212 - 88056	89056	1.4 Tdi 51/59 Kw
CFR28	7519043 - 036133062B/N - 408238321007Z - 408238321003Z		1.4 16v 55 Kw, 1.9 Tdi 66 Kw
CFR31	045128063G - 04512806D - 7519056 - A2C5911707 - A2C53096212	89056	1.4 16v 55 Kw
CFR40	03G128063C - 03G128063J - 88054 - 216058682 - 03G128063A - 7519054 - A2C59511698 - V10810024 - A2C53099815 - 03G128061A	89054	2.0 Tdi 100 Kw
CFR50	045128063G - 045128063D - 7519056	89056	1.4 Tdi 51/59 Kw
CFR51	059145950 - ACM069 - 05914595D - 7519076 - 059145950H - 10810026	89076	3.0 V6 Tdi 165 Kw
CFR54	4E0145950C/D/F/G/H		3.0 V6 Tdi 4M 165 Kw, 3.0 V6 Tdi 176 Kw
CFR56	03G128063A/G/M/Q - ACM073 - 7519055 - 88055 - A2C59511699 - A2C59512934	89055	1.4 Tdi 51/59 Kw, 1.9 Tdi 52/55/66/74/77 Kw, 2.0 90/96/103 Kw
CFR58	06A133064J/K/M - 88011 - 70370307 - 408237111012Z	89011	1.6 Benzina 74 Kw
CFR63	03G128063B/K/L/R - 700688804 - 88086 - 700688060	89086	2.0 16v Tdi 90/100/103/125/140/170 Kw
CFR66	0519128063A/B/D/E - 7519071 - ACM070 - 88071 - A2C5912937	89071	2.5 Tdi 120/132 Kw
CFR67	037133054D - ACM001 - 7519005 - 88005 - 70370306 - 10810007 - 408237111008Z	89005	1.6 Benzina 74 Kw
CFR68	06A133064M - 7519006 - 7519011 - 10810003 - 408237111012Z - 808237111013	89006	1.8 20V 92 Kw
CFR69	06A133063F - 88007 - 7519007 - 408236212004Z	89007	1.8 T 110 Kw
CFR70	058133063H - 88008 - 7519008 - V10810008 - 408237212002Z - ...009Z	89008	1.6 74 Kw, 1.8 85/92 Kw
CFR71	036133064E/J - ACM09 - 7519009 - 88009 - 408237111011Z	89009	1.4 16v 74/88 Kw
CFR77	06A133066 - ACM080 - 7519017 - 88017 - 408236111005Z - 37133064	89017	1.6 16v 74 Kw
CFR78	06A133066 - ACM080 - 7519017 - 88017 - 408236111005Z - 37133064	89017	1.6 16v 74 Kw

COD.	CODICE OEM	MEAT	APPLICAZIONI
CFR79	06A133063G - 88019 - 408237212007 - 408237212007Z	89019	1.8 T 110 Kw
CFR80	058133063Q - ACM020 - 408237212008 - 7519020 - 408237212008Z	89020	1.4 T 110/132 Kw
CFR81	036133064D - 7519021 - 88021 - 70370310	89021	1.4 16v 55 Kw
CFR82	06A133066E - 7519022 - 88022	89022	2.0 85 Kw
CFR83	06A133064H - 88023 - 40823111017 - 40823111017Z - 7519023	89023	2.0 85 Kw
CFR86	03713364A/C - 70370312 - 88002 - 7519002	89002	1.4 i 16v 74 Kw
CFR87	036133062M - 7519029 - 88029 - ACM039 - 408238323008	89029	1.4 16v 74 Kw, 1.6 16v 77 Kw
CFR92	038128063A/J/C - 39002015F - 88038 - 7519038 - 71430900 - 714309150 - CV1018412B1	89038	1.9 Sdi 47/50 Kw, 2.0 Sdi 51/55 Kw
CFR95	036133062L - 7519042 - 88042 - 10810013 - 408238321003 - 036133062N	89042	1.2 16v 40/47 Kw, 1.4 16v 55 Kw
CFR101	03C133062B - 7519049 - 88049 - ACM060 - A2C59511702	89049	1.2 16v 47/51 Kw, 1.6 16v 55 Kw
CFR102	06F133062E/Q/G - 88052 - 7519052 - A2C59511705	89052	1.8 Tsi 88/118 Kw, 2.0 Tfsi da 125 a 200 Kw
CFR103	03D133062E - 88051 - 7519051 - ACM061	89051	1.2 16v da 40 a 51 Kw
CFR104	06F133062E/Q/G - 88052 - 7519052 - A2C59511705	89052	1.8 Tsi 88/118 Kw, 2.0 Tfsi da 125 a 200 Kw
CFR110	030133064F - 7519004 - 133060001 - 88004 - 7519004 - 108100011 - 408237130004Z	89004	1.0 37 Kw, 1.4 16v 55 Kw, 1.6 16v 55 Kw
CFR111	036133064A/C - 408237111003Z - 408237111001 - 88002 - 7519002	89002	1.4 16v 74 Kw
CFR113	03G128063C - 03G128063J - 88054 - 216058682 - 03G128063A - 7519054 - A2C59511698 - V10810024 - A2C53099815 - 03G128061A	89054	2.0 Tdi 100 Kw
CFR120	06B133062D/P - ACM029 - 408238223003		1.6 75 Kw
CFR129	047133061G - ACM012 - 88012 - 10810022 - 408237430003 - 7519012	89012	1.0 37 Kw
CFR133	03L128063A/B/C/D/E - 88073 - 7519073	89073	2.0 Tdi 16v da 81 a 125 Kw
CFR136	077133062A - 0280750047		4.2 V8 Fsi da 225 a 265 Kw
CFR137	036133063C - 036133062D - 0280750059		1.4 Fsi 77 Kw, 1.6 Fsi 81 Kw, 2.0 Fsi 85 Kw
CFR138	077133062A - 0280750047		4.2 V8 Fsi da 225 a 265 Kw
CFR145	078133062B - 0280750030 - 078133062A/J		2.8 V6 140/142/148 Kw
CFR147	06A133064B - 40823711105Z - 7519112 - 88112 - ACM084	89112	2.5 81/85 Kw
CFR152	06B133062B/P/M - 99660511500 - 0280750009		1.8 T 20v 110/125 Kw
CFR155	06B133062E - 0280750080		1.8 92 Kw
CFR158	03L128063A/B/C/D/E - 7519073 - 88073	89073	2.0 Tdi da 81 a 125 Kw
CFR167	06A133064P - 88103 - 703703150 - 10810020 - 408237111016Z		1.8 T 20v 110 Kw
CFR168	037133064J - ACM086 - 703703160 - 88104 - 10810019 - 40823711108Z		2.0 85 Kw
CFR189	06B133062P - ACM029 - 06B133062D - 408238223003Z - 408238223003		1.6 75 Kw
CFR190	06B133062L - 408238323006 - 408238323006Z - ACM093		1.6 74 Kw, 2.0 85 Kw
CFR192	06F133062B - 4082420020032 - 06F133062S		2.0 Fsi 110 Kw
CFR211	06F133062 - ACM068 - 408238327003Z - 408238327003		2.0 Fsi 110 Kw
CFR213	03L128063Q		1.6 Tdi 77 Kw
CFR218	036133062Q - 108238323010 - 402383323010Z - ACM049		1.4 Fsi 63 Kw, 1.6 85 Kw

Volvo

COD.	CODICE OEM	MEAT	APPLICAZIONI
CFR41	58106038 - 41417038 - 8644344 - 8644345 - 8644346 - 8644387 - 9186739 - 9451987 - 9497244 - AH0015008A/C - 1H0013536A/B/C - AH0002030M - AH0012381C/E/A - AH0002030J/K/L - 65CFM92 - 65CFM9 - 13547509		C70, V70, S60, 2.0, 2.4, 2.9
CFR63	03G128063B/K/L/R - 70068804 - 88086 - 700688060	89086	2.0 16v Tdi 103 Kw
CFR118	0281002701 - 8692720		2.4 D da 93 a 147 Kw

DISTRIBUITO DA

**BLOCK[®]
STEM**

BLOCK STEM SRL

S.S. 16 uscita zona industriale Monopoli
70043 Monopoli [BA] [ITALIA]
C.F. R.I. BR P. IVA 02060270747
Tel. **080. 930 92 32** • Fax **080. 930 92 39**

www.epsrighenerati.com

infoLine
080 9309232
www.epsrighenerati.com
info@blockstem.it

