



TOOL CATALOGUE

current prices



K22_23/EN/XX/1

Non-binding recommended list prices excl. VAT
Prices valid from January 01, 2022 until December 31, 2022 at the latest.
Prices are subject to change before December 31, 2022. Errors excepted



EINFACH VIGOR.



www.vigor-equipment.com/konfigurator

 **KONVIGORATOR**



from page 68

	Tool trolleys and factory equipment	→ 32–87
	Tool storage	→ 88–121
	Hand tools	→ 122–233
	Torque tools	→ 234–237
	Pneumatic tools	→ 238–245
	General workshop tools	→ 246–259
	Diagnostics / Battery / Electrical System	→ 260–265
	Engine / Radiator / A/C	→ 266–277
	Oil service	→ 278–285
	Brakes	→ 286–303
	Wheels / tyres	→ 304–315
	Body	→ 316–323
	Motor / commercial vehicle chassis specialty tools	→ 330–417

Table of Contents



Tool trolleys with assortment	35–48	Service trolley	59		
Mobile work benches with assortment	49–50	Accessories for tool trolleys	59–67		
Tool trolleys without assortment	51–56	Storage system	68–80		
Mobile work benches without assortment	57–58	Accessories for storage system	81–87		
<hr/>					
Multiboxes	90– 91				
Soft foam inserts	92–121				
<hr/>					
Sockets	124–177	VDE tools	213–216		
Universal tool cases	178–179	Impact and releasing tools, scrapers	217–224		
Wrenches	180–190	Various hand tools	224–225		
Screwdrivers and bits	191–202	Cutting and sawing	225–233		
Pliers	203–212				
<hr/>					
Torque wrenches	236				
Rotation angle tester	237				
<hr/>					
Impact wrenches	239–240				
Air ratchets	241				
Die grinder	242				
Sanders / Drills	243				
Pneumatic air blow and body protection guns	244–245				
<hr/>					
Electrical system	261, 264				
Multimeter	261				
Cable release tools	262				
Crimping pliers set	263				
<hr/>					
Engine tools	267–269				
Cooling system diagnostics	270–272				
Turbo system diagnostics	273–274				
Compression and pressure loss testers	275–276				
<hr/>					
Oil dipsticks	279				
Oil filter tensioner adjusters	280–281				
Oil pumps and filling devices	282–285				
<hr/>					
Brake maintenance and bleeding	287–289				
Brake piston readjusting tools	290–292				
Brake discs tools	293–295				
Tube flaring tools	296–298				
Inspection tools	299–302				
<hr/>					
Impact sockets	305–307				
Service jacks and jack stands	308–311				
Wheel/tyre tools	311–315				
<hr/>					
Wiper arm puller set	318				
Repair and installation sets	319				
Induction heater and accessories	320–323				
<hr/>					
Motor vehicles chassis – Various	324–329	Standard wheel bearing tool sets	341–343	Bearing and bushing tool sets	372–381
Pressure and tension cylinders	332–334	Compact wheel bearing tool sets	344	Spring vice	382–385
Cylinder accessories	335–339	Screwed compact wheel bearing tool sets	345–353	Mobile work benches with specialty tool assortment	386–391
Mechanical drive	338–339	Wheel hub tool sets with 6 and 8 bolts	353	Special soft foam inserts	392–397
	368–371	Drive shaft tool sets	354	Commercial vehicle tool sets	398–417
Hydraulic pumps	340	Multiboxes	356–367		



Description of drive symbols

	For slotted screws
	For Phillips-Recess screws (PH)
	For Pozidriv screws (PZ)
	For inside hexagon screws
	For outside hexagon screws
	For inside TORX ® screws
	For tamper resistant TORX ® screws (inside TORX ® screws with pin)
	For outside TORX ® screws
	For screws with internal serration XZN
	For spline socket screws
	For Polydrive screws
	For inside 5-star screws with centre pin
	For Tri-Wing® screws
	Nominal size 6.3 mm
	Nominal size 10 mm
	Nominal size 12.5 mm
	Nominal size 20 mm
	Nominal size 25 mm
	Inside square
	Outside square
	Inside hexagon
	Outside hexagon
	EN/IEC 60900:2004

Description of icons

	Tools for motor vehicles
	Tools for trucks
	Operating instructions/Application note
	Central locking
	Weight of tool trolley
	Loading capacity of tool trolley
	Number of pieces
	Teeth
	Rotation angle
	Bore holes
	Shafts
	Magnet
	Operating time
	Charging time
	Weight
	Battery type
	Audible signal
	Working pressure
	Vibration
	rpm
	Sound level
	Max. loosening torque
	Twin hammer mechanism
	Coupler plug, nominal size
	Battery type
	Test equipment
	SUV/Van
	Agricultural machinery
	Industry
	QR Code
	Application video
	Hose length
	Oil capacity
	Hydraulic working
	Mechanical working

Alphabetical index of key words



A

Adapter / connection piece..... 132, 143–145, 162, 168, 172,
..... 274, 280, 287, 336–337, 371, 385
Air blow gun.....244
Air ratchet / air-operated power wrench.....241, 306
Assembly trolley..... 35–48, 51–57, 59–61, 63–67, 386
Assortment / set.....93–111, 117–118, 124–126, 134, 146, 150, 166,
..... 168–169, 172–177, 183, 187, 191, 193–195,
..... 197–199, 206–207, 213, 215, 219, 221, 223–224,
..... 232, 248–250, 255, 263, 267, 269–270, 273–274,
..... 279, 284, 288–289, 297–298, 306–307, 310–312,
..... 318–319, 324–325, 335–336, 338, 342–345,
..... 348–349, 352, 356, 359–361, 364–366, 368–369,
..... 371, 375–377, 379–380, 393, 395–396, 403–404,
..... 406–407, 409–410, 413, 415–417

B

Balance weight pliers.....312
Balance weight tool.....312, 314
Ball joint puller..... 372–373, 376, 405
Bits and screwdrivers..... 97, 101, 105–106, 108–110, 118,
..... 127, 130–132, 138–145, 147–149, 157–160,
..... 162, 191–202, 214–215, 281
Black Edition..... 35–36
Block and bushings tool..... 358, 362–365, 367,
..... 372–381, 398–402, 414–415
Bottle jack.....310
Box-end wrench..... 96, 108, 182, 184–188
Brush..... 219, 222, 229–231, 255, 339

C

Cable release tools.....262
Can holder.....61, 66
Cape chisel.....218, 220
Car body tools..... 318–323
Car light tester.....261
Cardan shaft puller.....328
Carpet knife.....226
Case.....90–91, 174, 178–179, 356–357,
..... 359–361, 364–366, 403–404
Centre punch.....218, 220
Chassis tool.....297, 300, 305–307, 312–314, 324–326, 328,
..... 341–345, 348–354, 356–357, 359–361,
..... 364–366, 368–371, 374–381, 385, 393–395,
..... 398–401, 403–404, 406–412, 414–415
Chisel..... 98–99, 102, 111, 118, 218
Circlip pliers..... 98, 205–208, 269, 339
Clamping screw tool.....325
Club hammer.....217
Combination pliers.....203, 210, 216
Combination spanner..... 95, 106–108, 118
Combination wrench..... 95, 106–108, 114, 118, 181
Compact wheel bearing tool..... 344, 348–353, 357,
..... 359–361, 395–396
Compression and engine leakage tester..... 275–276
Compressive hydraulic cylinder..... 332–336, 366, 392, 395
Connection piece / adapter..... 120, 132, 143–145, 162, 168, 172,
..... 274, 280, 287, 336–337, 371, 385
Cooling system diagnostics.....270, 272
Corner base cabinet.....76
Crimping pliers.....263
Cross recess (PH) tool..... 130, 139, 192–193, 215
Cutting knife.....226

D

Depth gauge.....312
Diagnostics..... 215, 224–225, 236–237, 261,
..... 270, 272–276, 279, 294–295, 300, 312
Diagonal cutter.....203, 210, 216
Die grinder.....242
Double box-end wrench..... 96, 182, 186–188
Double open-end wrench..... 95, 180
Double ratcheting box-end wrench..... 188–189
Double-joint pliers..... 98, 203–205
Drawer.....64
Drawer separation sheet.....62
Drift pin..... 98, 111, 218, 221
Drift punch..... 98, 111, 218, 221
Drill.....232
Drive shaft tools..... 342, 353–354, 366, 368–371, 393, 395, 401, 406–412
Drive-out pin..... 111, 218, 221

E

Engine leakage / compression tester..... 275–276
Extension..... 108, 131–132, 143–144, 161, 168, 171, 214
Extractor socket with spiral profile..... 150–151, 163

F

Feeler gauge.....224
File.....99, 228, 299
Fine tooth ratchet..... 126–127, 136, 154, 173
Finger ratchet.....127
Fixed castor.....63
Flat chisel.....218, 221
Flat wrench.....106
Flexible / wobble extension..... 131, 144, 161
Flexible handle.....155
Flexible screwdriver.....196
Foam mat.....65
Forceps.....249

G

Gas torch.....250
Grinding / Cutting / Machining..... 99, 225–228, 232, 242, 256, 258, 299
Grip pliers..... 98, 207
Guiding rail.....64

H

Hammer..... 99, 102, 110–111, 118, 217, 313, 371
Hand riveting tool.....209, 212
Hexagon socket profile tool... 95, 131, 135, 141–143, 149, 153, 157–158, 214
Hinged-door cabinet.....75, 77
Holder for paper reel.....61
Hose clamp pliers.....208, 269
HSS drill.....232
Hydraulic cylinder..... 332–336, 366, 392, 395
Hydraulic pump accessories.....337, 340
Hydraulic pump and accessories.....340
Hydraulic service jack.....308–309

I

Impact wrenches and sockets 94, 151–152, 163–165,
 168, 172, 239–240, 305–306

Induction heater and accessories 320–323

Inner bearing ring puller 326

Inside wedge (Ribe CV) tool 102, 149, 160

Inspection tool 299, 302

J

Jack stand and service jack 308–311

Jack-knife 226–227

Japan spatula 248

K

Kneeling mat 253

Knife / shears 225–227, 232

L

Lambda sensor tool 267

Lamp / light 254

Laptop table 59–60

Lock 64

M

Machinist's hammer 217

Magnetic pick-up tool 249

Manometer 337

Measuring / testing 215, 224–225, 236–237, 261–262, 270,
 272–276, 279, 294–295, 299–300, 302, 312

Mechanic's creeper 91

Mechanical Spindle 338

Mobile work bench 49–50, 57–58, 386–389

Motor vehicle chassis / steering tie rod /
 shock absorber 324, 351, 353, 385

Motor vehicle electrics / electronics 261–262

Motor vehicle wheel bearing tool 326, 341–345, 348–353, 356–357,
 359–361, 393–395, 398–401,
 403–404, 408, 410, 414

Multi-purpose profile tool 126, 130, 150, 157

Multi-Tool 211, 247

Multiboxes 90–91, 356–367, 396, 402–404

Multifunctional drain pan 250

Multimeter / measuring cable 261

N

Nut / socket 93, 100–101, 103–105, 108, 117, 124–152, 154–164,
 166–169, 171–177, 199–200, 213–214, 305–306

Nut-runners and inserts .. 94, 151–152, 163–164, 168, 172, 239–240, 305–306

O

Offset screwdriver 108–109, 197

Oil service tools 250, 279–281, 283–285

Open-end wrench 95–96, 106–108, 118, 183–185, 187, 190

P

Perforated plate 83

Pick-up tool with claws 249

Plastic cover 65

Pliers 97–100, 109–111, 115, 118, 203–212, 216, 263, 269, 311–312, 339

Pneumatic tools 94, 239–245, 306

Pozidriv (PZ) tool 130, 139

Pressure spindle 338

Pry bar 223–224, 312

Pull-handle 63, 66

Puller / extractor 268, 318, 326, 328, 351, 353, 372–373,
 376, 394, 405, 409, 411–412, 414

R

Ratchet / ratchet wrench 96, 108, 126–128, 136, 154–155,
 167, 173–174, 183–185, 187–189, 214

Ratchet / ratcheting wrench 96, 108, 126–128, 136, 154–155,
 167, 173–174, 183–185, 187–188, 214

Ratchet box 124–126, 133–134, 146, 150,
 166, 169, 174–177, 213, 306

Ratcheting combination wrench 96, 108–109, 113, 184–185, 187

Ratcheting combination wrench with hinge 96, 187

Ratcheting open-end wrench 183

Refractometer 272

Release lever 222–224, 312

Reversible ratchet 126–128, 136–137, 154–155, 167, 173, 214

Ribe CV tool 102, 149, 160

Rotary handle ratchet 128, 136, 154

Rotation angle tester 237

Round file 228

Round-nose pliers 216

Rubber hammer 313

S

Sabre saw 225

Safety platform 258

Safety spring vice 382, 385

Scraper 99, 219, 222, 339

Screw extractor 150–151, 163

Screwdriver socket 94–95, 105–106, 113, 130–131, 135,
 138–143, 147–149, 152–153, 157–160, 214

Screwdrivers and bits 94–95, 97, 100–101, 105–106, 108–110,
 114, 118, 127, 130–132, 138–145, 147–149,
 157–160, 162, 191–202, 214–215, 281

Seeger ring pliers 98, 205–208, 269, 339

Serration tool 95, 102, 148, 158–159, 169, 171

Service jack 308–311

Service jacks and jack stands 308–311

Service trolley 59

Set / assortment 93–111, 117–118, 120, 124–126, 134, 146–150, 166,
 168–169, 172–177, 183, 187, 191, 193–195, 197–199,
 206–207, 213, 215, 219, 221, 223–224, 232, 248–250, 255,
 263, 267, 269–270, 273–274, 276, 279, 284, 288–289,
 297–298, 306–307, 310–312, 318–319, 324–325, 335–336,
 338, 342–345, 348–349, 352–353, 360–361,
 364–365, 368–369, 371, 375–377, 379–380, 393,
 395–396, 406–407, 409–410, 413–417

Shears / knife 225–227, 232

Shock absorber tool 324, 327, 351, 353, 385

Silent block / bushings tool 364–365, 374–375, 377–381, 415

Sliding head 144

Sliding T-handle / sliding piece 128, 155, 167, 171

Slot profile tool 131, 138, 192, 215

Snap ring pliers 98, 205–208, 269, 339

Snipe nose pliers 203–204, 210, 216

Alphabetical index of key words



S

Socket.....	93–94, 100–101, 103–105, 108, 117, 124–152, 154–164, 166–169, 171–177, 199–200, 213–214, 293, 305–307
Socket combinations.....	112, 124, 174–177
Socket wrench set.....	124–126, 133–134, 146, 150, 166, 169, 174–177, 213, 306
Soft face hammer.....	217, 313
Soft foam insert.....	93–111, 115–118, 120, 359, 392–396
Soldering iron.....	250
Solid steel ratchet.....	126–127, 136, 154
Spanner socket set.....	124–126, 133–134, 146, 150, 166, 169, 174–177
Spark plug tools.....	138, 157, 204
Spatula.....	248
Specialty tool for brakes.....	287–290, 292–302, 339, 354, 405, 414
Specialty tools for axles.....	328
Specialty tools for electricians.....	100, 102, 213–216
Specialty tools for wheels / tyres.....	305–307, 312–314
Spin type speeder.....	128
Spindle, mechanical.....	338
Spring bolt tool.....	413, 416–417
Square drive	
6.3 mm (¼ inch).....	93, 103–105, 117, 124–132, 145, 176–177
10 mm (¾ inch).....	132–145, 162, 178–179
12.5 mm (½ inch).....	93, 103–105, 117, 131, 144–152, 154–164, 168, 176–177, 214, 239, 241, 305–306
20 mm (¾ inch).....	166–169
25 mm (1 inch).....	169, 171
Steering wheel level.....	313
Storage shelf.....	65, 83–84
Supporting joint tool.....	325, 375–376
Swivel castor.....	63
Synthetic repair tool.....	319

T

T-handle screwdriver.....	109, 198–199
Tamper-resistant TORX® tool.....	130, 139–140, 160
Tape measure.....	224
Telescopic inspection mirror.....	248
Testing / measuring.....	236–237, 261, 275–276, 299, 302
Tool case / box.....	90–91, 174, 178–179, 356, 359, 364–366, 403–404
Tool chest.....	52
Tool hook.....	67
Tool organisation.....	35–61, 63–67, 69–71, 73, 75, 77, 80–85, 87, 93–106, 108–111, 117–118, 120, 359, 386, 392–396
Tool trolley and accessories.....	35–48, 51–57, 59–61, 63–67, 386, 390–391
Tools for commercial vehicles.....	405–417
Tools for engines.....	267, 269, 272–275
Tools for motor vehicles.....	261–262, 324, 326, 341–345, 348–353, 356–357, 359–361, 385, 393, 395, 398–401, 403–404, 408, 410, 414
Torque tool.....	236
TORX® Tool.....	94, 97, 102, 129–130, 135, 138–140, 148, 152, 157, 159–160, 174, 194–195, 197, 199
Tractive hydraulic cylinder.....	332–334
Tray.....	250
Tube cutter.....	232
Tube flaring tool.....	296–299, 301
Turbo system diagnostics.....	273–274
Twist drill bits.....	232
Tyre iron pry bar.....	312
Tyre lever.....	312
Tyre pressure control system (TPCS) tool.....	307

U

Under-bench drawer cabinet.....	72–74
---------------------------------	-------

U

Universal joint.....	131, 143, 161, 172
Universal pliers.....	210–211

V

V-ribbed belt tool.....	269
Vacuum and pressure pump.....	276, 283
VDE tools.....	100, 102, 213–216
Vernier calliper.....	225
Vice.....	67
VIGOR 1000.....	38–40, 49–50, 58
VIGOR 1000 XD.....	47–48, 56
VIGOR 1000 XL.....	43–46, 54–55, 57
Voltmeter.....	215
VSS – VIGOR Storage System.....	67, 69–77, 80, 83–85, 87

W

Wall cabinet.....	80
Wall unit.....	67, 69–77, 80–85, 87
Window pane holder.....	257
Wiper arm puller.....	318
Wire brush.....	229
Wire stripper.....	216
Wobble / flexible extension.....	131, 144, 161
Wooden worktop.....	65
Work bench and accessories.....	49–50, 57–58, 386
Work lamp / light.....	254
Work platform / ladder.....	258
Workshop equipment.....	67, 69–71, 73, 75, 77, 80–85, 87, 250–254
Workshop torch / light.....	254
Worktop.....	65, 81–82
Wrench.....	95–96, 106–108, 182–188
Wrenching bar.....	223–224, 312

X

XZN tools.....	95, 102, 135, 148, 153, 158–159, 171
----------------	--------------------------------------



Numerical Index

VIGOR No.	Page	VIGOR No.	Page	VIGOR No.	Page	VIGOR No.	Page	VIGOR No.	Page	VIGOR No.	Page
V1008	185	V1461N-6X7	180	V1740	249	V1963-23	271	V2068	158	V2121	158
V1009	185	V1461N-8X9	180	V1741	249	V1963-24	271	V2069	157	V2122	158
V1010	185	V1461N-10X11	180	V1764	249	V1963-25	271	V2070	157	V2123	158
V1021	185	V1461N-12X13	180	V1781	174	V1963N	270	V2071	145	V2124	158
V1022	185	V1461N-14X15	180	V1782	297-298, 301	V1970	34, 53	V2072	157	V2126	158
V1023	185	V1461N-16X17	180	V1783	218	V1976	130	V2073	157	V2128	158
V1025	185	V1461N-18X19	180	V1785	211	V1977	130	V2074	157	V2129	158
V1026	185	V1461N-20X22	180	V1787	228	V1979	130	V2075	157	V2130N	130
V1027	185	V1461N-21X23	180	V1788	228	V1980	130	V2076	157	V2132	158
V1028	185	V1461N-24X27	180	V1789	228	V1981	130	V2077	157	V2133	159
V1029	185	V1461N-25X28	180	V1790	228	V1982	130	V2078	157	V2134	159
V1030	185	V1461N-30X32	180	V1801	228	V1983	130	V2079	157	V2135	159
V1031	185	V1524N	182	V1802	207	V1984	130	V2080	158	V2136	130
V1135	217	V1524N-6X7	182	V1803	207	V1985	130	V2081	158	V2137	159
V1138	215	V1524N-8X9	182	V1804	207	V1986	130	V2082	158	V2138	130
V1208	191	V1524N-10X11	182	V1808	207	V1987	130	V2083	158	V2139	130
V1209	191	V1524N-12X13	182	V1897	126	V1988	157	V2084	158	V2140	130
V1212	217	V1524N-14X15	182	V1898	150	V1989	157	V2085	158	V2141	130
V1213	219	V1524N-16X17	182	V1901	34, 52	V1990	157	V2086	158	V2142	130
V1214	218	V1524N-18X19	182	V1902	34, 52	V1991	157	V2087	158	V2143	138
V1215	218	V1524N-20X22	182	V1903	64	V1992	157	V2088	158	V2144	138
V1216	218	V1524N-21X23	182	V1904	64	V1993	157	V2089	158	V2145	138
V1217	218	V1524N-24X27	182	V1905	64	V1994	157	V2090	158	V2146	138
V1218	218	V1524N-25X28	182	V1906	64	V1995	157	V2091	158	V2149	140
V1219	218	V1524N-30X32	182	V1907	63	V1996	157	V2092	158	V2151	159
V1220	218	V1571	313	V1908	63	V1997	157	V2094	158	V2152	159
V1221	218	V1584	312	V1909	65	V1998	157	V2095	158	V2153	159
V1222	218	V1586	272	V1917	148	V1999	157	V2096	158	V2154	159
V1281	280	V1616	210	V1918	148	V2000	157	V2097	158	V2155	159
V1283	219	V1617	210	V1919	149	V2001	157	V2098	158	V2156	159
V1293	172	V1637	191	V1963-1	271	V2002	157	V2099	158	V2157	159
V1301	224	V1657	312	V1963-3	271	V2003	157	V2100	158	V2158	159
V1304	225	V1698	192	V1963-4	271	V2004	157	V2101	157	V2159	159
V1345	226	V1699	192	V1963-5	271	V2014	132	V2102	157	V2160	159
V1368N	219	V1700	192	V1963-6	271	V2016N	137	V2103	157	V2161	159
V1369	223	V1701	192	V1963-7	271	V2017N	137	V2104	157	V2162	159
V1371	222	V1702	192	V1963-8	271	V2018N	137	V2105	157	V2163	159
V1371-1	222	V1703	192	V1963-9	271	V2019N	137	V2106	157	V2165	159
V1371-2	222	V1704	192	V1963-10	271	V2020N	137	V2107	157	V2167	159
V1371-3	222	V1706N	175	V1963-11	271	V2027	215	V2108	145	V2168	159
V1371-4	222	V1707	232	V1963-12	271	V2028	215	V2109	162	V2169	159
V1371-5	222	V1711-1	292	V1963-13	271	V2029	215	V2110	162	V2170	159
V1371-6	222	V1711N	292	V1963-14	271	V2030	215	V2111	168	V2171	159
V1372	219	V1713	225	V1963-15	271	V2059	158	V2112	279	V2172	159
V1409	198	V1714	224	V1963-16	271	V2060	158	V2113	158	V2173	159
V1410	199	V1715	225	V1963-17	271	V2061	215	V2114N	144	V2174	159
V1423	313	V1716	206	V1963-18	271	V2062	215	V2115N	143	V2175	159
V1426N	210	V1717	206	V1963-19	271	V2063	215	V2116N	144	V2176	159
V1438	249	V1718	207	V1963-20	271	V2064	215	V2117N	143	V2177	159
V1446	226-227	V1719	206	V1963-21	271	V2065	158	V2118N	143	V2178	159
V1447	227	V1722	261	V1963-22	271	V2066	158	V2119N	138	V2179	159
V1461N	180	V1728	297			V2067	158	V2120N	138	V2180	159

Numerical Index



VIGOR No.	Page	VIGOR No.	Page	VIGOR No.	Page	VIGOR No.	Page	VIGOR No.	Page	VIGOR No.	Page
V2181	159	V2257	306	V2318N	166	V2424N	129	V2487	219	V2554	297
V2182	159	V2261N	137	V2319N	167	V2425N	129	V2488	219	V2555	297
V2183	159	V2262N	137	V2320N	168	V2426N	129	V2489	198	V2556	297
V2184	159	V2263N	137	V2321N	168	V2427N	131	V2490	199	V2558	297
V2185	129	V2264N	137	V2322N	167	V2428N	131	V2491	222-223	V2559	297
V2186	129	V2265N	137	V2323N	167	V2429N	131	V2492	222-223	V2561N	156
V2187	129	V2266N	137	V2324N	167	V2430N	131	V2493	222-223	V2562N	156
V2188	129	V2267N	137	V2325N	167	V2431N	131	V2494	222-223	V2563N	156
V2189	129	V2268N	137	V2326N	167	V2432N	131	V2495	222-223	V2564N	156
V2194	139	V2269N	137	V2327N	167	V2433N	131	V2496	147	V2565N	156
V2195	139	V2270N	137	V2328N	167	V2434N	131	V2497	199	V2566N	156
V2196	157	V2271N	137	V2329N	167	V2435N	131	V2498	199	V2567N	156
V2197	157	V2272N	137	V2331N	167	V2436N	130	V2499	263	V2568N	156
V2200	160	V2273N	137	V2332N	167	V2437N	130	V2499-A	263	V2569N	156
V2201	149	V2274N	137	V2333N	167	V2438N	130	V2499-B	263	V2570N	156
V2202	160	V2275N	137	V2334N	167	V2439N	130	V2499-C	263	V2571N	156
V2203	160	V2276N	137	V2335N	167	V2440N	130	V2499-D	263	V2572N	156
V2204	160	V2277N	137	V2336N	167	V2441N	130	V2499-F	263	V2573N	155
V2205	160	V2278N	137	V2337N	167	V2442N	130	V2501	199	V2574N	156
V2206	160	V2279N	142	V2338	253	V2443N	130	V2502	198	V2575N	161
V2207	160	V2280N	142	V2338-XL	253	V2444N	130	V2503	198	V2576N	161
V2208	160	V2281N	142	V2347	254	V2445N	130	V2504	198	V2577N	161
V2209	160	V2282N	142	V2379N	35	V2446N	130	V2505	198	V2578N	157
V2210	160	V2283N	142	V2393-S	61	V2447N	130	V2506	198	V2579N	156
V2211	160	V2284N	142	V2393-XD	61	V2452N	132	V2507	198	V2580N	156
V2212	160	V2285N	142	V2394	232	V2453N	128	V2508	219	V2581N	156
V2213	160	V2286N	138	V2395	232	V2454N	131	V2509	219	V2582N	157
V2214	160	V2287N	138	V2396	232	V2455N	132	V2511N	280	V2584N	156
V2215	160	V2288N	138	V2397	61	V2456N	132	V2512	312	V2585N	156
V2216	160	V2289N	139	V2400	179	V2457N	131	V2513	312	V2586N	156
V2217	160	V2290N	139	V2401	163	V2458N	128	V2514	312	V2587N	156
V2218	160	V2291N	139	V2402	163	V2459N	272	V2515	312	V2588N	156
V2219	160	V2292N	139	V2403	163	V2460N	146	V2516	312	V2589N	156
V2220	160	V2293N	139	V2404	150	V2461N	176	V2517	67	V2590N	156
V2221	160	V2294N	139	V2405	163	V2462	64	V2518	67	V2591N	156
V2222	160	V2295N	140	V2406	163	V2464	179	V2519	67	V2592N	157
V2223	160	V2296N	140	V2407	163	V2465N	156	V2520	67	V2593N	130
V2224	160	V2297N	140	V2408	163	V2466	297	V2521	280	V2594N	130
V2225	160	V2298N	140	V2409	163	V2467	297	V2522	306	V2595N	130
V2226	160	V2299N	140	V2410	163	V2471	306	V2523	318	V2596N	130
V2227	160	V2300N	140	V2412	210	V2472	306	V2533N	129	V2597N	131
V2228	160	V2301N	140	V2413N	129	V2473	306	V2534N	129	V2598N	156
V2229	160	V2302N	140	V2414N	125	V2474	306	V2535N	129	V2599N	156
V2230	160	V2303N	140	V2415N	129	V2475	306	V2536N	129	V2600N	156
V2231	160	V2305N	134	V2416N	129	V2477	310	V2537N	129	V2603N	156
V2232	160	V2311N	137	V2417N	129	V2478	310	V2538N	129	V2613N	138
V2233	160	V2312N	137	V2418N	129	V2481	308	V2539N	129	V2614N	138
V2234	313	V2313N	137	V2419N	129	V2482	199	V2540	297	V2615N	138
V2235	313	V2314N	137	V2420N	129	V2483	199	V2542	179	V2616N	143
V2249	300	V2315N	137	V2421N	129	V2484	199	V2551	297	V2626	232, 297
V2250	300	V2316	254	V2422N	129	V2485	199	V2552	297	V2627	226
V2256N	167	V2317N	168	V2423N	129	V2486	198	V2553	297	V2628	216



Numerical Index

VIGOR No.	Page	VIGOR No.	Page	VIGOR No.	Page	VIGOR No.	Page	VIGOR No.	Page	VIGOR No.	Page
V2629	216	V2794	206	V2869	332	V2945	365	V3021	378-379, 404	V3108	398, 402-403
V2630	216	V2795	237	V2871	371	V2946	365	V3022	378	V3109	398, 403
V2631	308	V2804	187	V2872	371	V2947	364	V3023	378-379	V3110	399, 403
V2632	308	V2805	187	V2873	332, 369, 416-417	V2948	364	V3024	378	V3111	399
V2639	308	V2806	187	V2874	334, 416	V2949	364	V3025	378	V3112	399
V2640	308	V2807	187	V2879	400	V2950	364	V3026	378-379	V3113	399
V2641	216	V2808	187	V2881	398-399, 403	V2961	364	V3027	378-379	V3120	340
V2643	216	V2809	187	V2882	398, 403	V2962	364	V3028	378	V3123	333
V2645	279	V2810	187	V2883	398-399, 403	V2963	365	V3029	378	V3124	332-333
V2647N	162	V2811	187	V2885	374	V2964	365	V3030	378	V3125	333
V2648	311	V2812	187	V2886	377	V2965	365	V3031	378	V3126	333, 336, 338, 371, 414, 416
V2662	217	V2813	187	V2888	399	V2966	365	V3033	348, 371	V3127	333, 336, 378-379, 414, 416
V2663	217	V2814	187	V2889	398	V2967	365	V3034	348, 371	V3128	332-334
V2664	217	V2817	187	V2890	401, 404	V2968	365	V3035	348, 371	V3129	333, 376
V2665	217	V2818	187	V2891	374	V2969	365, 368-369	V3036	348, 371	V3130	333-334
V2667N	155	V2820	185	V2892	374	V2971	365	V3039	341, 403	V3131	334
V2683	324	V2821	184	V2893	374	V2972	365	V3040	341, 403	V3132	334, 336, 368, 410
V2684	324	V2822	184	V2894	374	V2973	365	V3044	381	V3133	334, 336, 368-369
V2687	174	V2823	184	V2895	374	V2974	365	V3045	376	V3134	333
V2699N	129	V2824	184	V2896	374	V2975	365	V3046	376	V3135	336, 378, 380-381
V2700N	129	V2825	184	V2897	374	V2976	365	V3047	376	V3136	336, 378, 380-381
V2701N	129	V2826	184	V2898	374	V2977	365	V3048	376	V3137	336, 379-381
V2705	188	V2827	184	V2899	374	V2978	365	V3049	376	V3138	379
V2712N	36	V2828	184	V2900	374	V2979	365	V3050	381	V3139	378
V2722	129	V2829	184	V2901	374	V2980	365	V3051	381	V3140	371
V2723	129	V2830	184	V2902	374	V2981	365	V3052	381	V3141	340
V2724	138	V2831	184	V2903	374	V2982	365	V3053	358, 374-375	V3142	374
V2725	138	V2832	184	V2904	374	V2983	339	V3055	374	V3147	370
V2726	138	V2833	184	V2905	374	V2984	339	V3056	358, 363, 374-375	V3148	370
V2727	138	V2837	105	V2906	374	V2985	378	V3057	374	V3149	398-399, 402-403
V2728	138	V2838	105	V2907	374	V2986	378	V3058	399, 403	V3199	333
V2729	138	V2845	341	V2908	374	V2987	378	V3059	404	V3205	338
V2730	157	V2846	340, 361	V2909	374	V2988	378	V3060	342-343	V3206	338
V2731	157	V2847	340, 360	V2910	337	V2989	376	V3063	348	V3207	336
V2732	157	V2849	366, 370	V2913	376	V2990	376	V3070	343	V3208	336
V2733	157	V2850	336	V2914	376	V2991	376	V3071	343	V3209	336
V2734	157	V2851	337	V2915	376	V2992	378	V3072	341	V3210	336
V2735	157	V2853	338	V2916	378	V2993	378	V3087	403	V3212	377
V2762	310-311	V2854	333, 360-361, 366	V2917	381	V2994	339	V3088	399, 403	V3213	377
V2781	203	V2857	379	V2918	381	V2995	378	V3089	404	V3214	377
V2782	203	V2858N	405	V2919	381	V2996	378	V3090	398, 403	V3215	377
V2783	204	V2859	350	V2920	405, 416	V2997	378	V3091	398, 403	V3216	334
V2788	212	V2860	344, 348, 359	V2922	371	V2998	378	V3092	334, 410	V3217	332
V2788-3.2	212	V2861	350	V2923	376	V2999	376	V3100	377		
V2788-4.0	212	V2862	350	V2924N	167	V3000	376	V3101	377		
V2788-4.8	212	V2863	350	V2927	339	V3001	376	V3102	377		
V2788-6.4	212	V2864	344, 348, 359	V2928	339	V3002	376	V3103	377		
V2789N	299	V2867	339, 416-417	V2936	415	V3008	338	V3105	398		
V2790N	225			V2937	414, 417	V3009	332	V3106	398-399, 402-403, 415		
V2791	206			V2941	128	V3010	332	V3107	398-399, 415		
V2792	206			V2942	415	V3011	332				
V2793	207					V3012	332				
						V3013	401, 404				
						V3014	379				
						V3015	379				
						V3016	379				
						V3017	379				
						V3018	333-334				
						V3019	378-379				
						V3020	378-379				

Numerical Index



VIGOR No.	Page	VIGOR No.	Page	VIGOR No.	Page	VIGOR No.	Page	VIGOR No.	Page	VIGOR No.	Page
V3219	336	V3369	194	V3634	410	V3743	163	V3760-VW	291	V4202	271
V3220	336	V3370	194	V3635	185	V3744	163	V3760-X	291	V4218	335
V3222	409, 416-417	V3371N	171	V3636	185	V3745	163	V3760-Z	291	V4219	37
V3224	415	V3373N	171	V3641	380	V3746	163	V3760N	290	V4220	337
V3225	415	V3374N	171	V3642	380	V3747	163	V3761	411	V4221	200
V3226	415	V3375N	171	V3649	358, 375	V3750	412	V3762	411	V4222	200
V3231	409, 416	V3376N	171	V3650	375	V3751	369	V3763	412	V4223	200
V3232	406, 409	V3377N	171	V3651N	132	V3753	345, 348, 357	V3764	412	V4224	200
V3233	414, 416	V3378N	171	V3652N	145	V3755	344	V3765	412	V4225	200
V3234	414, 416	V3379N	171	V3653	240	V3758	345, 348, 357	V3863	324	V4227	247
V3235	414, 416	V3380N	171	V3657	311	V3760-0	291	V3865	348-349	V4228	247
V3236	414, 416	V3381	269	V3661	324	V3760-0-DISC	291	V3866	349	V4229	334, 417
V3237	414, 416	V3391	194	V3670N	319	V3760-1	290	V3867	411	V4230	109
V3238	415-416	V3392	194	V3671N	319	V3760-11	290	V3868	368	V4231	109
V3256	379	V3393	194	V3672N	319	V3760-12	290	V3869	337	V4233	273
V3259	413	V3403	375	V3673N	319	V3760-2	290	V3871	341, 344-345, 352-354, 367	V4235	217
V3260	413	V3404	375	V3676N	319	V3760-3	290	V3873	341, 344-345, 352-353	V4241	247
V3261	413	V3405	375	V3677N	319	V3760-4	290	V3874	341, 344-345, 352-353	V4242	334
V3262	413	V3423	380	V3678	405	V3760-5	290	V3898	236	V4243	335
V3263	409, 412-413, 416-417	V3424	380	V3680	349, 359	V3760-6	290	V3899	236	V4244	335
V3264	406, 409	V3425	380	V3681	284	V3760-7	290	V4111	64	V4245	335
V3265	406, 409	V3427N	200	V3682	284	V3760-8	291	V4112	64	V4246	335
V3266	406-407, 414-415	V3431	410, 415	V3683	284	V3760-9	291	V4113	284	V4248	325
V3267	406-407, 414-415	V3433	399, 403	V3684	284	V3760-A	290	V4114	284	V4249	325
V3275	336	V3434	410	V3685	284	V3760-A1	291	V4115	284	V4250	325
V3277N	177	V3436	380	V3686	284	V3760-B	290	V4122	65	V4251	334
V3278	169	V3437	410	V3687	284	V3760-B1	291	V4126	325	V4252	334
V3287	401, 404	V3438	410	V3688	284	V3760-C	290	V4130	103	V4253	334
V3302	379	V3439	410	V3689	284	V3760-D	290	V4153	318	V4254	334
V3309	232	V3440	410	V3690	284	V3760-E	290	V4154	318	V4255	340
V3330	214	V3441	236	V3691	284	V3760-F	290	V4155	318	V4257	271
V3331	214	V3451	232	V3708	368-369	V3760-G	290	V4156	318	V4258	271
V3332	214	V3541	217	V3709	368-369	V3760-H6	291	V4157	318	V4274	226
V3333	214	V3551N	319	V3729	271	V3760-H7	291	V4158	318	V4275	226
V3334	214	V3562	193	V3731	345	V3760-IV	291	V4159	318	V4278	248
V3335	214	V3563	312	V3732	345	V3760-J	290	V4160	318	V4279	248
V3336	214	V3571	269	V3734N	124	V3760-K	291	V4161	318	V4303	198
V3337	214	V3582	337	V3735	212	V3760-K1	291	V4162	318	V4304	274
V3338	214	V3597	192	V3735-3.2	212	V3760-K2	291	V4163	318	V4305	274
V3339	214	V3598	192	V3735-4.0	212	V3760-M	291	V4164	318	V4306	274
V3340	214	V3599	192	V3735-4.8	212	V3760-N	291	V4165	318	V4308	226
V3341	214	V3600	192	V3735-6.4	212	V3760-P	291	V4188	103	V4309	306
V3342	214	V3601	192	V3735-M5	212	V3760-Q	291	V4192	273	V4310N	224
V3343	213	V3602	192	V3735-M6	212	V3760-R	291	V4196	209	V4311	131
V3344	214	V3607	188	V3735-M8	212	V3760-S	291	V4199	199	V4312	131
V3366	195	V3609	192	V3735-M10	212	V3760-T	291	V4200	200	V4313	131
V3367	194	V3610	192	V3738	207	V3760-V	291	V4201	283	V4317	161
V3368	194	V3612	337	V3738-S	207			V4201-1	283	V4318	161
		V3613	192	V3739	207					V4319	161
		V3614	340	V3740	368						
		V3615	312	V3741	151						
		V3631	380	V3742	163						



Numerical Index

VIGOR No.	Page	VIGOR No.	Page	VIGOR No.	Page	VIGOR No.	Page	VIGOR No.	Page	VIGOR No.	Page
V4322	245	V4451-5	262	V4481-X-5	66	V4587	104	V4646M-12	255	V4699-3	338
V4324	261	V4451-6	262	V4481-X/375	43	V4588	108	V4646M-13	255	V4699-4	338
V4324-1	261	V4451-7	262	V4481-X/466	44	V4594	343	V4646M-14	255	V4699-5	338
V4324-2	261	V4451-8	262	V4481-X/499	45	V4594-1	343	V4646M-15	255	V4699-6	338
V4325	276	V4451-9	262	V4481-XD	56	V4596	336	V4646M-16	255	V4699-7	338
V4342	336	V4451-10	262	V4481-XD-1	64	V4597	336	V4646M-17	255	V4700-A	91
V4354	385	V4451-11	262	V4481-XD-2	64	V4598	342, 356	V4646M-18	255	V4700-L	90, 101-102
V4369	283	V4451-12	262	V4481-XD-3	64	V4598-2	342, 357	V4646M-19	255	V4700-R	91
V4381	287	V4451-13	262	V4481-XD-4	63	V4598-3	342-343, 357	V4646M-8	255	V4700-XL	90
V4381-1	287	V4451-14	262	V4481-XD-5	66	V4598-4	342, 357	V4646M-9	255	V4700-XXL	91
V4381-2	287	V4451-15	262	V4481-XD/469	47	V4598-10	342	V4646N-10	255	V4701	282
V4381-3	287	V4451-16	262	V4481-XD/775	48	V4598-11	342	V4646N-11	255	V4708	197
V4381-4	287	V4451-17	262	V4484	281	V4598-12	342-343	V4646N-12	255	V4709N	156
V4383	284	V4451-18	262	V4491	352	V4598-13	342	V4646N-13	255	V4726	106
V4384	284	V4451-19	262	V4493	352	V4598-14	342	V4646N-14	255	V4727	106
V4385N	284	V4451-2	262	V4497	46	V4598-15	342	V4646N-15	255	V4728	106
V4398N	161	V4451-20	262	V4499	411	V4598-16	342	V4646N-16	255	V4729	106
V4399	294	V4451-21	262	V4500	411	V4598-20	342	V4646N-17	255	V4737	208
V4411	288	V4451-22	262	V4501	108	V4598-21	342	V4646N-18	255	V4752	105
V4413	281	V4451-23	262	V4510	111	V4598-22	342	V4646N-19	255	V4753	105
V4414	281	V4461	275	V4511	111	V4598-23	342	V4646N-8	255	V4758	59
V4415	281	V4472N	181	V4514	104	V4598-30	342-343, 357	V4646N-9	255	V4800N	239
V4416	296	V4473N	181	V4521	117	V4599	343	V4646S-10	255	V4813	34, 58
V4416-1	296, 298	V4473N-6	181	V4542	41	V4601	413	V4646S-11	255	V4813-1	65
V4416-2	296, 298	V4473N-7	181	V4545	407, 409	V4602	413	V4646S-12	255	V4813-2	65
V4416-3	296, 298	V4473N-8	181	V4546	407, 409	V4602-1	413	V4646S-13	255	V4814	34, 57
V4416-4	296, 298	V4473N-9	181	V4547	407, 409	V4603	416	V4646S-14	255	V4814-1	64
V4416-5	296	V4473N-10	181	V4548	407, 409	V4604	417	V4646S-15	255	V4814-2	63
V4418	195	V4473N-11	181	V4549	407, 409	V4605	408	V4646S-16	255	V4814-3	63
V4419	194	V4473N-12	181	V4550	406-407	V4606	408	V4646S-17	255	V4814-4	65
V4420	194	V4473N-13	181	V4551	333	V4607	408	V4646S-18	255	V4884	155
V4421	194	V4473N-14	181	V4552	333	V4608	408	V4646S-19	255	V4884-01	155
V4422	194	V4473N-15	181	V4553	333	V4609	408, 413	V4646S-8	255	V4885	223
V4425N	178	V4473N-16	181	V4554	409	V4610	408	V4646S-9	255	V4891	320
V4427	206	V4473N-17	181	V4555	409	V4614	342, 357	V4651	226	V4891-1	320
V4428	207	V4473N-18	181	V4556	409	V4629	341, 356	V4655	191	V4891-2	320
V4429	206	V4473N-19	181	V4560	39	V4629-1	341, 357	V4661	217	V4891-3	320
V4430	206	V4473N-20	181	V4561	40	V4631	120	V4661-1	217	V4891-3.5	322
V4431	307	V4473N-21	181	V4562	406-407	V4632	120	V4663	219	V4891-3.5-1	323
V4432/6	193	V4473N-22	181	V4563	406-407	V4633	120	V4664	196	V4891-3.5-2	323
V4433	193	V4473N-24	181	V4564	406-407	V4634	406-407	V4665	196	V4891-3.5-3	323
V4434	193	V4473N-27	181	V4565	406, 416	V4635	414	V4666	196	V4891-3.5-4	323
V4435	193	V4473N-30	181	V4566	407, 417	V4636	326	V4667	192	V4891-3.5-5	323
V4436	193	V4473N-32	181	V4569	408	V4636-1	326	V4668	288	V4891-3.5-6	323
V4437	193	V4473N-36	181	V4570	408	V4637N	208	V4680	359-362	V4891-4	320
V4438	193	V4476-1	385	V4571	408	V4638	258	V4690	225	V4891-5	321
V4441	206	V4476N	382	V4572	408	V4641	208	V4697	296	V4891-6	321
V4442	206	V4477	164	V4573	408	V4642	328	V4697-1	296	V4891-7	321
V4451	262	V4478	164	V4574	408	V4646	255	V4697-2	296, 298	V4891-8	321
V4451-1	262	V4481	34, 54	V4575	408	V4646M-10	255	V4699	338	V4891-9	321
V4451-3	262	V4481-X	34, 55	V4577	411	V4646M-11	255	V4699-1	338	V4891/6	321
V4451-4	262	V4481-X-4	63	V4586	117			V4699-2	338		

Numerical Index



VIGOR No.	Page	VIGOR No.	Page	VIGOR No.	Page	VIGOR No.	Page	VIGOR No.	Page	VIGOR No.	Page
V4891-10	321	V5013	100	V5109	105	V5437	154	V5550S-18	163	V5909	300
V4893	66	V5013-L	100	V5109-L	105	V5480	248	V5550S-19	163	V5916	372
V4904	395	V5015	100	V5111	110	V5485N	196	V5550S-21	163	V5916-1	373
V4904-L	395	V5015-L	100	V5111-L	110	V5488	250	V5550S-22	163	V5916-2	373
V4906	395	V5017	99	V5115	104	V5489	34, 51	V5550S-24	163	V5916-XL	373, 416-417
V4906-L	395	V5017-L	99	V5115-L	104	V5489-1	64	V5554	360	V5922	272
V4908	393	V5018	120	V5128	356	V5489-2	65	V5554-2	361	V5930	305
V4908-L	393	V5019	201	V5156	49	V5489-3	64	V5591	224	V5931	305
V4915	393	V5020	202	V5158	50	V5489-4	64	V5601	197	V6000-01	73
V4915-L	393	V5024	168	V5160	386	V5489-5	66	V5602	94	V6000-010	84
V4917	394	V5025	168	V5168	366	V5493	204	V5602-L	94	V6000-01083-D	82
V4917-L	394	V5026	168	V5169	364	V5494	204	V5630	211	V6000-01083-XD	82
V4921	393	V5027	351, 362	V5169-A	365	V5496	205	V5633	97	V6000-011	76
V4921-L	393	V5042	192	V5169-A45	365	V5496-1	205	V5633-L	97	V6000-01357	81
V4930	294	V5043	192	V5169-A55	365	V5497	205	V5634	109	V6000-01357-D	82
V4942	197	V5044	192	V5169-A70	365	V5502	201	V5634-L	109	V6000-01357-X	81
V4944-REP	127	V5045	219	V5169-A76	365	V5505	172	V5635	110	V6000-01357-XD	82
V4944-S	127	V5048	279	V5169-A80	365	V5505-1/2	172	V5635-L	110	V6000-015	83
V4944-XS	127	V5055	38	V5170	118	V5505-1/4	172	V5636	110	V6000-01541	81
V4945-REP	136	V5058	392	V5170-L	118	V5505-3/8	172	V5636-L	110	V6000-01541-X	81
V4945-S	136	V5058-L	392	V5173	108	V5512	250	V5637	111	V6000-0155	83
V4946-S	154	V5062	393	V5173-L	108	V5513	298	V5637-L	111	V6000-0155SP	83
V4951	183	V5062-L	393	V5175	109	V5513-1	298	V5638	118	V6000-0155XL	83
V4961	185	V5064	392	V5175-L	109	V5513-2	298	V5638-L	118	V6000-017	83
V4962	185	V5066	396	V5180	59, 63	V5513-3	298	V5649	299	V6000-01725	81
V4963	185	V5066-L	396	V5182	168	V5531	257	V5650	203	V6000-01725-D	82
V4964	185	V5068	97	V5183	168	V5549	357	V5660	272	V6000-01725-X	81
V4965	185	V5068-L	97	V5191	59, 63	V5549-1-NL	396	V5661	196	V6000-01725-XD	82
V4966	185	V5070	99	V5202	124	V5549-1N	396	V5671	239	V6000-017XL	83
V4971	93	V5070-L	99	V5202-1	128	V5550L	152	V5672	242	V6000-018	84
V4971-L	93	V5072	99	V5202-2	132	V5550L-10	163	V5673	242	V6000-018XL	84
V4973	93	V5072-L	99	V5202-4	129	V5550L-11	163	V5674	241	V6000-019	73
V4973-L	93	V5075	96	V5202-4.5	129	V5550L-12	163	V5675	241	V6000-019XL	74
V4975	93	V5075-L	96	V5202-5	129	V5550L-13	163	V5676	267	V6000-01XL	73
V4975-L	93	V5077	96	V5202-5.5	129	V5550L-14	163	V5677	250	V6000-02	75
V4987	96	V5077-L	96	V5202-6	129	V5550L-15	163	V5678	251	V6000-020	87
V4987-L	96	V5081	101	V5202-7	129	V5550L-16	163	V5681	210	V6000-02036	81
V4989	97	V5081-L	101	V5202-8	129	V5550L-17	163	V5691	299	V6000-02036-D	82
V4989-L	97	V5085	102	V5202-9	129	V5550L-18	163	V5741N	358	V6000-02036-X	81
V4991	97	V5085-L	102, 392	V5202-10	129	V5550L-19	163	V5885	223	V6000-02036-XD	82
V4991-L	97	V5087	102	V5202-11	129	V5550L-21	163	V5902	358, 377	V6000-02215	81
V4995	98	V5087-L	102	V5202-12	129	V5550L-22	163	V5902-1	377	V6000-02215-X	81
V4995-L	98	V5091	95	V5202-13	129	V5550L-24	163	V5902-2	377	V6000-02404	81
V4999	98	V5091-L	95	V5202-14	129	V5550S	151	V5903-3	351	V6000-02404-X	81
V4999-L	98	V5095	94	V5420	346	V5550S-10	163	V5903N	351	V6000-02588	81
V5004	98	V5095-L	94	V5421	347	V5550S-11	163	V5904	354	V6000-02588-D	82
V5004-L	98	V5097	95	V5422	347	V5550S-12	163	V5904-1	354	V6000-02588-X	81
V5006	99	V5097-L	95	V5423	347	V5550S-13	163	V5904-3	354, 367	V6000-02588-XD	82
V5006-L	99	V5099	94	V5424	347	V5550S-14	163	V5904-4	354, 367	V6000-02XL	76
V5009	120	V5099-L	94	V5425	347	V5550S-15	163	V5905	353, 362	V6000-03	77
V5011	100	V5103	101	V5434	42	V5550S-16	163	V5906	353	V6000-030	72
V5011-L	100	V5103-L	101	V5436	127	V5550S-17	163	V5906-1	353		



Numerical Index

VIGOR No.	Page	VIGOR No.	Page	VIGOR No.	Page	VIGOR No.	Page	VIGOR No.	Page	VIGOR No.	Page
V6000-030XL	72	V6008	136	V6101	140	V6158	143	V6395	60	V6685-3/10	62
V6000-031	72	V6012	154	V6102	140	V6159	143	V6396	60	V6685-4/10	62
V6000-031XL	72	V6012-REP	154	V6103	140	V6160	143	V6397	61	V6686/5	62
V6000-032	74	V6014	126	V6104	140	V6161	143	V6398	59	V6687/5	62
V6000-032XL	74	V6014-REP	126	V6105	140	V6194	142	V6435	253	V6688	62
V6000-033	75	V6015	119	V6106	141	V6200	221	V6435-XL	253	V6688-XD	62
V6000-033XL	75	V6015-L	119	V6107	141	V6200-2	221	V6452	327	V6688-XL	62
V6000-036	78	V6017	135	V6108	141	V6200-3	221	V6452-1	327	V6721	95
V6000-036XL	78	V6018	135	V6109	141	V6200-4	221	V6452-5		V6721-L	95
V6000-037	78	V6019	135	V6110	141	V6200-5	221	V6452-6		V6722	96
V6000-03XL	77	V6027	280	V6111	141	V6200-6	221	V6452-16	327	V6722-L	96
V6000-04	80	V6028	308	V6112	141	V6200-7	221	V6452-17	327	V6723	95
V6000-040/4	85	V6028-1	308	V6113	141	V6200-8	221	V6452-18	327	V6723-L	95
V6000-041/4	85	V6028-2	308	V6114	141	V6202	133	V6452-19	327	V6724	107
V6000-042	79	V6028-3	308	V6115	141	V6202-1	137	V6452-21	327	V6724-L	107
V6000-042XL	79	V6029	309	V6116	141	V6202-2	145	V6452-22	327	V6726	107
V6000-043	85	V6029-1	309	V6117	141	V6202-3	143	V6452-24	327	V6726-L	107
V6000-044	79	V6029-2	309	V6118	141	V6202-4	144	V6452-250	327	V6741	268
V6000-044XL	79	V6029-3	309	V6119	141	V6202-5	144	V6452-H6	327	V6742	252
V6000-046	80	V6030	222	V6120	141	V6202-8	138	V6452-H7	327	V6752-8	186
V6000-046XL	80	V6030-12	222	V6121	141	V6202-9	138	V6452-H8	327	V6752-9	186
V6000-04XL	80	V6030-16	222	V6122	141	V6202-10	138	V6468	251	V6752-10	186
V6000-05	83	V6030-20	222	V6123	141	V6202-11	138	V6554	241	V6752-11	186
V6000-050	86	V6031	309	V6124	141	V6202-12	138	V6591	337	V6752-12	186
V6000-051	86	V6031-1	309	V6125	141	V6202-13	138	V6592	337	V6752-13	186
V6000-052	86	V6031-2	309	V6126	141	V6202-14	138	V6605	252	V6752-14	186
V6000-053	86	V6031-3	309	V6127	141	V6202-15	138	V6606	252	V6752-15	186
V6000-054	87	V6038	136	V6128	141	V6202-16	138	V6610-L	66	V6752-16	186
V6000-055	83	V6038-REP	136	V6129	141	V6202-17	138	V6610-XD	66	V6752-17	186
V6000-055P	83	V6039	173	V6130	141	V6202-19	138	V6610-XL	66	V6752-18	186
V6000-055XL	83	V6048	190	V6131	141	V6202-21	138	V6611-6X8	189	V6752-19	186
V6000-06	84	V6049	190	V6137	142	V6202-22	138	V6611-10X12	189	V6752/12	186
V6000-0676	81	V6068	202	V6138	142	V6210-4	220	V6611-14X18	189	V6752/5	187
V6000-0676-D	82	V6082	139	V6139	142	V6210-10	220	V6611-20X24	189	V6799	211
V6000-0676-X	81	V6083	139	V6140	142	V6220-10	221	V6611/4	189	V6800-50	230
V6000-0676-XD	82	V6084	140	V6141	142	V6220-16	221	V6612	154	V6800-75	230
V6000-07	84	V6085	140	V6142	142	V6220-20	221	V6614	126	V6801-65	231
V6000-0860	81	V6086	140	V6143	142	V6220-29	221	V6614-REP	126	V6802	230
V6000-0860-X	81	V6087	140	V6144	142	V6220/4	221	V6632	291, 293	V6803-75	230
V6000-0861	81	V6088	140	V6145	142	V6221	60	V6633	291, 293	V6803-100	230
V6000-0861-D	82	V6089	140	V6146	142	V6222	98	V6634	291, 293	V6804	231
V6000-0861-X	81	V6090	140	V6147	142	V6222-L	98	V6635	291, 293	V6805	231
V6000-0861-XD	82	V6091	140	V6148	142	V6230-5	220	V6636	293	V6806	231
V6000-09	85	V6092	140	V6149	142	V6230-7	220	V6638	136	V6807	113
V6000-3	71	V6093	140	V6150	67	V6299	254	V6643	107	V6807-4	229
V6000-3-X	71	V6094	140	V6151	142	V6300-5	285	V6643-L	107	V6807-L	113
V6000-3P1	69	V6095	140	V6152	142	V6300-8	285	V6649	106	V6808	114
V6000-3P1XL	69	V6096	140	V6153	142	V6300-13	285	V6649-L	106	V6808-L	114
V6000-3P1XL-X	69	V6097	140	V6154	142	V6309	305	V6650	118	V6809	113
V6000-3P2	70	V6098	140	V6155	142	V6393	61	V6650-L	118	V6809-4	229
V6000-3P2XL	70	V6099	140	V6156	143	V6393-S	61	V6685-1/20	62	V6809-L	113
V6000-3P2XL-X	70	V6100	140	V6157	143	V6394	60	V6685-2/20	62	V6810	113

Numerical Index



VIGOR No.	Page	VIGOR No.	Page	VIGOR No.	Page	VIGOR No.	Page	VIGOR No.	Page	VIGOR No.	Page
V6810-115K40	256	V7017-T30	165	V7133-7	363	V7202-27	156	V7471L-10	289	V7538-13	137
V6810-115K60	256	V7017-T40	165	V7133-8	363	V7202-30	156	V7471L-11	289	V7538-14	137
V6810-115K80	256	V7017-T45	165	V7133-9	363	V7202-32	156	V7471L-12	289	V7538-15	137
V6810-125K40	256	V7017-T50	165	V7133-10	363	V7212	169	V7471L-7	289	V7538-16	137
V6810-125K60	256	V7017-T55	165	V7133N	362-363	V7212-H14	169	V7471L-8	289	V7538-17	137
V6810-L	113	V7017-T60	165	V7135	244	V7212-H17	169	V7471L-9	289	V7538-18	137
V6811	116	V7017-T70	165	V7135-150	244	V7212-H19	169	V7471S-10	289	V7538-19	137
V6811-76	256	V7017-T80	165	V7143-10	244	V7212-H21	169	V7471S-11	289	V7538/10	135
V6811-115	256	V7018	153	V7154-1	367	V7212-M14	169	V7471S-12	289	V7548	264
V6811-125	256	V7018-M5	165	V7154-2	367	V7212-M16	169	V7471S-7	289	V7548-1	264
V6811-L	116	V7018-M6	165	V7154-4	367	V7212-M18	169	V7471S-8	289		
V6812	116	V7018-M8	165	V7154N	354	V7221	251	V7471S-9	289		
V6812-L	116	V7018-M10	165	V7158	293	V7244	302	V7512-10	156		
V6813	114	V7018-M12	165	V7158-1	293	V7251	402	V7512-11	156		
V6813-L	114	V7018-M14	165	V7158-2	293	V7251-1	402	V7512-12	156		
V6814	114	V7018-M16	165	V7158-3	293	V7251-2	402-403	V7512-13	156		
V6814-L	114	V7018-M18	165	V7158-4	293	V7251-3	402	V7512-14	156		
V6815	115	V7019	153	V7158-5	293	V7251-4	402	V7512-15	156		
V6815-L	115	V7019-H5	165	V7158-6	293	V7251-5	402	V7512-16	156		
V6816	115	V7019-H6	165	V7158-7	293	V7252	400	V7512-17	156		
V6816-L	115	V7019-H8	165	V7158-8	293	V7259	302	V7512-18	156		
V6817	115	V7019-H10	165	V7181	314	V7261	396	V7512-19	156		
V6817-L	115	V7019-H12	165	V7181-1	314	V7261-L	396	V7512-20	156		
V6818	116	V7019-H14	165	V7181-2	314	V7263	394	V7512-21	156		
V6818-L	116	V7019-H17	165	V7181-3	314	V7263-L	394	V7512-22	156		
V6820	108	V7019-H19	165	V7181-4	314	V7265	397	V7512-23	156		
V6820-L	108	V7026	387	V7181-5	314	V7265-L	397	V7512-24	156		
V6821	112	V7026-1	388	V7181-6	314	V7267	394	V7512-27	156		
V6821-L	112	V7026-2	389	V7201	395	V7267-L	394	V7512-30	156		
V6822	112	V7027	355	V7201-L	395	V7270	397	V7512-32	156		
V6822-L	112	V7050	352	V7202	146	V7270-L	397	V7512-8	156		
V6824	344	V7061	350	V7202-1	155	V7273	397	V7512/17	147		
V6899	240	V7099	227	V7202-2	162	V7273-L	397	V7514-10	129		
V6903	243	V7099-S	227	V7202-3	161	V7275	403	V7514-11	129		
V6904	243	V7099/2	227	V7202-4	161	V7276	390	V7514-12	129		
V6905	243	V7106	257	V7202-5	161	V7276-2	391	V7514-13	129		
V6906	242	V7107	257	V7202-8	156	V7285	284	V7514-14	129		
V6906-10	242	V7124	194	V7202-9	156	V7286	284	V7514-4	129		
V6907	245	V7124-PH1	194	V7202-10	156	V7287	284	V7514-4.5	129		
V6907-1	245	V7124-PH2	194	V7202-11	156	V7288	284	V7514-5	129		
V6917	301	V7124-PH3	194	V7202-12	156	V7291	404	V7514-5.5	129		
V6917-REP	301	V7124-PZ1	194	V7202-13	156	V7323	94	V7514-6	129		
V6952	224	V7124-PZ2	194	V7202-14	156	V7323-L	94	V7514-7	129		
V6956	328	V7124-T20	194	V7202-15	156	V7401	295	V7514-8	129		
V6973	254	V7124-T25	194	V7202-16	156	V7402	258	V7514-9	129		
V6973-1	254	V7124-T30	194	V7202-17	156	V7403	258	V7514/13	125		
V7001	315	V7133	362	V7202-18	156	V7471	289	V7520	100		
V7001/4	315	V7133-2	363	V7202-19	156	V7471-A	289	V7520-L	100		
V7010-125K80	256	V7133-3	363	V7202-20	156	V7471-T	289	V7525	329		
V7015	119	V7133-4	363	V7202-21	156	V7471-TL	289	V7538-10	137		
V7015-L	119	V7133-5	363	V7202-22	156	V7471-TS	289	V7538-11	137		
V7017	152	V7133-6	363	V7202-24	156	V7471-W	289	V7538-12	137		

Wallmek-No	VIGOR No.	Designation	Page
01-00001-001	V2945	Adapter plate for V2868	365
01-00001-002	V2946	Thrust rod · adjustable · 90 mm for V2868	365
01-00001-101	V2947	Pressure sleeve	364
01-00001-102	V2948	Pressure sleeve	364
01-00001-103	V2949	Pressure sleeve	364
01-00001-104	V2950	Pressure sleeve	364
01-00001-105	V2961	Pressure sleeve	364
01-00001-106	V2962	Pressure sleeve	364
01-00001-107	V2963	Pressure sleeve	365
01-00001-108	V2964	Pressure sleeve	365
01-00001-109	V2965	Pressure sleeve	365
01-00001-110	V2966	Pressure sleeve	365
01-00001-201	V2967	Pressure pipe	365
01-00001-202	V2968	Pressure pipe	365
01-00001-203	V2969	Pressure pipe	365, 368–369
01-00001-204	V2971	Pressure pipe	365
01-00001-205	V2972	Pressure pipe	365
01-00001-206	V2973	Pressure pipe	365
01-00001-207	V2974	Pressure pipe	365
01-00001-208	V2975	Pressure pipe	365
01-00001-209	V2976	Pressure pipe	365
01-00001-210	V2977	Pressure pipe	365
01-00001-211	V2978	Pressure pipe	365
01-00001-212	V2979	Pressure pipe	365
01-00001-213	V2980	Pressure pipe	365
01-00001-214	V2981	Pressure pipe	365
01-00001-400	V5169-A	Pressure sleeve expansion set	365
01-00001-401	V5169-A45	Adapter pressure sleeves · 45 mm	365
01-00001-402	V5169-A55	Adapter pressure sleeves · 55 mm	365
01-00001-403	V5169-A70	Adapter pressure sleeves · 70 mm	365
01-00001-404	V5169-A76	Adapter pressure sleeves · 76 mm	365
01-00001-405	V5169-A80	Adapter pressure sleeves · 80 mm	365
01-00001-999	V5066	Pressure sleeve set	396
01-00004	V2867	Circlip tool	339, 416–417
01-00004-013	V2992	Pin Ø 2.5 mm	339
01-00004-014	V2993	Pin Ø 3.0 mm	339
01-00004-015	V2994	Pin Ø 3.5 mm	339
01-00009	V2916	Silent block bushing set · rear · BMW	378
01-00009-001	V2995	Assembly ring	378
01-00009-002	V2996	Counterholder ring	378
01-00009-003	V2997	Washer with thread	378
01-00010-001	V3028	Washer with thread	378
01-00010-002	V2998	Thrust washer	378
01-00010-003	V3029	Retaining ring	378
01-00010-004	V3030	Mounting ring	378
01-00011-001	V3031	Washer with thread	378
01-00018	V2860	Compact wheel bearing removal set · universal	344, 348, 359
01-00018-003	V3873	Fixing screw · M 14	341, 344–345, 352–353

Wallmek-No	VIGOR No.	Designation	Page
01-00018-004	V3874	Bolt · M 12	341, 344–345, 352–353
01-00020	V2853	Spindle set · mechanical	338
01-00020-001	V3008	Drawbar with flange nut M 18	338
01-00020-002	V3206	Washer	338
01-00020-003	V3205	Thrust washer	338
01-00022-003	V3403	Pressure pipe	375
01-00022-004	V3404	Pressure plate	375
01-00022-005	V3405	Adapter ring	375
01-00022-010	V3649	Bushing set longitudinal strut · FORD · Volvo	358, 375
01-00022-020	V3650	Press frame	375
01-00023	V3436	Tool set for double silent blocks VAG	380
01-00023-001	V3423	Mounting pipe	380
01-00023-002	V3424	Thrust washer	380
01-00023-003	V3425	Pressure pipe	380
01-00024	V3751	Installation tool set for BMW drive shafts (hydraulic)	369
01-00024-001	V3709	Adapter · M 24x1.5 mm	368–369
01-00024-002	V3708	Adapter · M 27x1.5 mm	368–369
01-00024-005	V3868	Thrust washer · inside Ø 23 mm · suitable for M 20 spindle	368
01-00024-010	V3740	Installation tool set for BMW drive shafts (mechanical)	368
01-00025	V3631	Transverse control arm bushing set · front · VW T5	380
01-00025-001	V3641	Thrust plate · inside Ø 23 mm · suitable for M 22 spindle	380
01-00025-002	V3642	Pressure sleeve	380
01-00026	V3731	Removal set, universal, for screwed wheel bearing unit	345
01-00026-020	V3758	Pressure foot set (removal) for screwed wheel bearing units	345, 348, 357
01-00027	V3732	Removal set, universal, for screwed wheel bearing unit	345
01-00027-020	V3753	Pressure foot set (removal) for screwed wheel bearing units	345, 348, 357
01-00028	V3865	Wheel bearing unit / compact wheel bearing · screwed · removal set · universal	348–349
01-00030	V4551	Tractive and compressive hydraulic cylinder 18 tonnes	333
01-00030-001	V4552	Hydraulic cylinder · 18 tonnes · without accessories	333
01-00030-005	V4553	Pressure shaft · M 24x3 mm	333
01-00031-018	V4342	Striker nut · M 18	–
01-00033	V4491	Compact wheel bearing installation set · universal	352
01-00033-020	V4493	Pressure foot (pair) for compact wheel bearing assembly tool set · universal	352
01-00033-110	V3680	Compact wheel bearing installation set · universal	349, 359

References Wallmek / VIGOR



Wallmek-No	VIGOR No.	Designation	Page
01-00033-125	V3866	Wheel bearing unit and compact wheel bearing · screwed · removal / assembly tool set · universal	349
01-00035	V4598	Wheel bearing, hub tool and drive shaft set · universal	342, 356
01-00035-001	V4614	Support disc · tapered · \varnothing 33.8 mm · for V4598	342, 357
01-00035-002	V4598-2	Support disc · tapered · \varnothing 38.8 mm · for V4598	342, 357
01-00035-003	V4598-3	Support disc · tapered · \varnothing 43.8 mm · for V4598 · V4599	342–343, 357
01-00035-004	V4598-4	Support disc · tapered · \varnothing 59.8 mm · for V4598	342, 357
01-00035-010	V4598-10	Bearing washer \varnothing 61.8 – 62.8 mm · inside hole \varnothing 20.25 mm · suitable for spindle M 20	342
01-00035-011	V4598-11	Bearing washer \varnothing 63.8 – 64.8 mm · inside hole \varnothing 20.25 mm · suitable for spindle M 20	342
01-00035-012	V4598-12	Bearing washer \varnothing 65.8 – 66.8 mm · inside hole \varnothing 20.25 mm · suitable for spindle M 20	342–343
01-00035-013	V4598-13	Bearing washer \varnothing 68.8 – 70.8 mm · inside hole \varnothing 20.25 mm · suitable for spindle M 20	342
01-00035-014	V4598-14	Bearing washer \varnothing 72.5 – 74.5 mm · inside hole \varnothing 20.25 mm · suitable for spindle M 20	342
01-00035-015	V4598-15	Bearing washer \varnothing 76.5 – 78.5 mm · inside hole \varnothing 20.25 mm · suitable for spindle M 20	342
01-00035-016	V4598-16	Bearing washer \varnothing 80.8 – 82.8 mm · inside hole \varnothing 20.25 mm · suitable for spindle M 20	342
01-00035-020	V4598-20	Bearing shell \varnothing 93 mm for V4598	342
01-00035-021	V4598-21	Bearing shell \varnothing 75.5 mm for V4598	342
01-00035-022	V4598-22	Bearing shell \varnothing 93 mm for V4598	342
01-00035-030	V4598-30	Pressure pipe length 78 mm for V4598 · V4599	342–343, 357
01-00036	V4594	Wheel bearing fixation adjustable	343
01-00036-020	V4594-1	Pressure foot set for V4594	343
01-00037	V4629	Wheel hub removal tool · universal	341, 356
01-00037-020	V4629-1	Pressure foot set for V4629	341, 357
01-00038	V4599	Wheel bearing tool set AUDI Q7 · VW Touareg · PORSCHE Cayenne	343
01-00039	V4699	Pressure spindle set · manual	338
01-00039-001	V4699-1	Pressure spindle · M 30	338
01-00039-002	V4699-2	Adapter · 1.1/2" · M 30	338
01-00039-010	V4699-4	Press axle · 50x \varnothing 19 mm	338
01-00039-011	V4699-5	Press axle · 85x \varnothing 19 mm	338
01-00039-020	V4699-6	Press axle · 56x \varnothing 24 mm	338
01-00039-021	V4699-7	Press axle · 100x \varnothing 24 mm	338
01-00039-040	V4699-3	Washer \varnothing 18.8x3 mm (4 pcs)	338

Wallmek-No	VIGOR No.	Designation	Page
01-00040	V5027	Wheel hub puller	351, 362
01-00041-002	V3871	Cross beam for various pressure feet	341, 344–345, 352–354, 367
01-00041-003	V5904-3	Sliding plate	354, 367
01-00041-005	V5904-4	Screw · M 14 x 45 · inside hexagon	354, 367
01-00041-020	V3755	Pressure foot set (removal) for compact wheel bearings	344
01-00042-002	V5903-2	Washer	–
01-00042-003	V5903-3	Drawbar · M 22 · 121 mm	351
01-00042-010	V7061	Screw set for SUBARU rear wheel bearings	350
01-00042-B	V5903N	Wheel bearing puller for screwed wheel bearings	351
01-00044	V5904	Device for the removal of drive shafts · 6 and 8 holes	354
01-00044-030	V5904-1	Pressure foot set	354
01-00045	V5905	Wheel hub / wheel bearing puller · for 6 and 8 bolts	353, 362
01-00046	V5906	Wheel bearing unit · screwed · removal tool set · universal	353
01-00046-020	V5906-1	Pressure foot set	353
01-00047-020	V7050	Removal tool for screwed 4-hole wheel hubs/wheel bearings with uneven brake guard	352
01-00048	V7154-4	Brake disc removal set	367
01-00048-001	V7154-1	Removal foot · individual	367
01-00048-002	V7154-2	Fixing plate · individual	367
01-00048-030	V7154N	Extension set for brake disc removal tool without crossbar	354
01-00049	V7027	Wheel hub / bearing puller	355
01-00050-010	V5422	Bearing plate · \varnothing 85-95 mm	347
01-00050-011	V5423	Supporting plate · \varnothing 89-105 mm	347
01-00050-020	V5421	Expansion set · ROVER	347
01-00050-050	V5425	ROVER standard wheel bearing expansion set	347
01-00050-100	V5420	ROVER standard wheel bearing removal and installation set	346
02-00009	V2923	Supporting joint tool set FORD	376
02-00009-001	V2999	Pressure sleeve	376
02-00009-002	V3000	Mounting / dismantling cap	376
02-00009-003	V3001	Mounting bushing	376
02-00009-004	V3002	Dismounting bushing	376
02-00010-001	V3433	Pressure sleeve · inside \varnothing 23 mm · suitable for M 22 spindle	399, 403
02-00011	V7251	Multibox wheel bearing tool set IVECO Daily	402
02-00011-001	V7251-1	Pressure ring, IVECO Daily	402
02-00011-002	V7251-2	Large pressure pipe	402–403
02-00011-003	V7251-3	Bearing washer, IVECO Daily	402
02-00011-004	V7251-4	Support disc, IVECO Daily	402
02-00011-005	V7251-5	Bearing shell, IVECO Daily	402

Wallmek-No	VIGOR No.	Designation	Page
02-00015	V7133	Compact wheel bearing removal and installation set	362
02-00015-001	V7133-2	Insert thread including guide M24 · L110 mm	363
02-00015-002	V7133-3	Insert crossbar CC = 160–186 mm · L 226 mm	363
02-00015-003	V7133-4	Insert fixation L 266 mm · M14 · M16	363
02-00015-004	V7133-5	Fixing screw M14 · tapered	363
02-00015-005	V7133-6	Insert hollow shanks L 242 mm · 2x M14	363
02-00015-006	V7133-7	Insert plate CC = 135–145 mm	363
02-00015-007	V7133-8	Fixation steering knuckle M14	363
02-00015-015	V7133N	Compact wheel bearing installation expansion set	362–363
02-00020	V7275	Multibox · starter set · wheel bearing of van front axle	403
03-00003-005	V3263	Screw · M 22x60 mm	409, 412–413, 416–417
03-00004-001	V3262	Press frame	413
03-00005-001	V2937	Brake adjuster puller	414, 417
03-00006-001	V3264	Thrust rod · 250 mm Ø 31 mm	406, 409
03-00006-002	V3265	Thrust rod · 140 mm Ø 31 mm	406, 409
03-00006-006	V3266	Pressure pipe	406–407, 414–415
03-00006-007	V3267	Pressure pipe	406–407, 414–415
03-00006-009	V3261	Thrust rod · 115 mm Ø 29 mm	413
03-00006-010	V3260	Thrust rod · 100 mm Ø 29 mm	413
03-00006-011	V3259	Pressure pipe · large	413
03-00006-013	V3238	Thrust washer	415–416
03-00006-014	V3237	Thrust washer · Ø 63 mm	414, 416
03-00006-015	V3236	Thrust washer · Ø 50 mm	414, 416
03-00006-016	V3235	Thrust washer · Ø 44 mm	414, 416
03-00006-017	V3234	Thrust washer · Ø 63 mm	414, 416
03-00006-018	V3233	Thrust washer · Ø 57 mm	414, 416
03-00006-020	V3232	Thrust rod · 50 mm Ø 31 mm	406, 409
03-00006-021	V3231	Pressure plate	409, 416
03-00006-025	V3634	Spacer screw M 22	410
03-00006-026	V3440	Pressure sleeve	410
03-00006-027	V4634	Pressure pipe for V4565 · V4566	406–407
03-00006-028	V4563	Adapter plate for V4565 · V4566	406–407
03-00006-029	V4564	Pressure pipe 85 mm for V4565 · V4566	406–407
03-00006-030	V4562	Pressure sleeve for V4565 · V4566	406–407
03-00008-32T	V4601	Spring bolt set for SCANIA 32 tonnes	413
03-00008-45T	V4602	Spring bolt set for SCANIA 45 tonnes	413
03-00009	V4635	Spring bushing set · universal	414
03-00010	V2942	Bushing set for drawbars	415
03-00012	V2943	Supplementary set for changing the brake anchor bolts	–
03-00012-001	V3230	Pressure pipe	–
03-00012-003	V3227	Pressure sleeve (big)	–
03-00013	V2936	Bushing set · for SAF axle · 150 mm	415
03-00013-001	V3226	Assembly ring	415

Wallmek-No	VIGOR No.	Designation	Page
03-00013-002	V3225	Dismounting/mounting ring	415
03-00013-003	V3224	Dismounting/mounting washer	415
03-00014-001	V2920	Ball joint puller · universal	405, 416
03-00015	V2873	Tractive and compressive hydraulic cylinder 8.5 tonnes	332, 369, 416–417
03-00015-001	V3009	Hydraulic cylinder 8.5 tonnes	332
03-00015-006	V3010	Impact body with o-ring	332
03-00015-012	V3011	Thrust rod · adjustable M 22	332
03-00016-020	V3222	Pressure foot	409, 416–417
03-00016-32T	V4554	Wheel hub puller set for trucks · buses and trailers 32 tonnes	409
03-00016-45T	V4555	Wheel hub puller set for trucks · buses and trailers 45 tonnes	409
03-00020	V3434	Wheel bearing tool set for SCANIA	410
03-00020-001	V3437	Thrust washer · Ø 130 mm	410
03-00020-002	V3438	Thrust washer · Ø 125 mm	410
03-00020-003	V3439	Protective sleeve	410
03-00021-020	V4603	Universal pressure tool set 32 tonnes · universal	416
03-00021-021	V4604	Universal pressure tool set 45 tonnes · universal	417
03-00022	V3750	Wheel hub extractor for low-height trailers	412
03-00022-001	V3763	Plate	412
03-00022-002	V3764	Leg	412
03-00022-003	V3765	Thrust washer · SAF Ø 73 mm	412
03-00025	V3678	Brake disc removal (floating) · Volvo · RENAULT · DAF	405
03-00026	V4229	Tractive and compressive hydraulic cylinder 45 tonnes	334, 417
03-00026-001	V4242	Hydraulic cylinder 45 tonnes	334
03-00026-006	V4254	Impact body · M 27	334
03-00026-012	V4251	Thrust block · adjustable · M 30	334
03-00027-002	V3762	Thrust rod · M 24	411
03-00027-003	V4577	Thrust rod · M 30 for V4500	411
03-00027-010	V3761	Base component with thread	411
03-00027-012	V3867	Adapter for base component with thread	411
03-00027-32T	V4499	Wheel hub puller commercial vehicle · 32 tonnes	411
03-00027-45T	V4500	Wheel hub puller commercial vehicle · 45 tonnes	411
03-00028	V2874	Tractive and compressive hydraulic cylinder 32 tonnes	334, 416
03-00028-001	V3216	Hydraulic cylinder 32 tonnes	334
03-00031-001	V4550	Press frame for V4565 · V4566	406–407
03-00031-002	V4556	Plate with thread for V3750 · V4554 · V4555	409
03-00031-200	V4569	King pin removal expansion set	408
03-00031-201	V4570	Support for V4569	408
03-00031-202	V4571	Extension for V4569	408
03-00031-203	V4575	Extension for V4569	408

References Wallmek / VIGOR



Wallmek-No	VIGOR No.	Designation	Page
03-00031-204	V4572	Extension for V4569	408
03-00031-205	V4573	Pressure plate for V4569	408
03-00031-206	V4574	Pressure plate for V4569	408
03-00031-220	V4605	King pin removal expansion set MERCEDES-BENZ Actros und Atego	408
03-00031-221	V4610	Centring thrust block	408
03-00031-300	V4606	Steering knuckle removal expansion set MAN TGA · TGX and TGS	408
03-00031-302	V4608	Pressure pipe	408
03-00031-303	V4607	Guide ring for V4605 · V4606	408
03-00031-32T	V4565	King pin removal set 32 tonnes · universal	406, 416
03-00031-45T	V4566	King pin removal set 45 tonnes · universal	407, 417
03-00032-001	V4545	Thrust rod · M 30 · length 30 mm · Ø 38 mm	407, 409
03-00032-002	V4546	Thrust rod · M 30 · length 140 mm · Ø 38 mm	407, 409
03-00032-003	V4547	Extension · 50 mm · Ø 38 mm for V4555 · V4566	407, 409
03-00032-004	V4548	Extension · 70 mm · Ø 38 mm for V4555 · V4566	407, 409
03-00032-005	V4549	Extension · 100 mm · Ø 38 mm for V4555 · V4566	407, 409
03-00032-101	V4609	Thrust rod · M 30 · length 137 mm · Ø 29 mm · for V4605 · V602	408, 413
03-00032-102	V4602-1	Thrust rod length 64 mm Ø 29 mm	413
04-00003	V4255	Manometer	340
04-00007-001	V3287	Special nut · M 16x1.5 mm	401, 404
04-00007-004	V3013	Special nut · M 14x2 mm	401, 404
04-00015-001	V3582	Protective cover	337
04-00016	V3612	Manometer	337
04-00021	V4218	Support set for hydraulic cylinders	335
04-00021-001	V4243	Bracket without shell	335
04-00021-013	V4244	Clamp Ø 70 mm	335
04-00021-014	V4245	Clamp Ø 85 mm	335
04-00021-015	V4246	Clamp Ø 100 mm	335
04-00024	V5916	Ball joint ejector · hydraulic 4.5 tonnes	372
04-00024-023	V5916-1	Ball joint ejector extension pins	373
04-00024-024	V5916-2	Pressure foot extension	373
04-00028	V5916-XL	Ball joint ejector · hydraulic 8.8 tonnes	373, 416–417
09-000111	V7133-9	Screw sleeve 28x14.5 x 3 mm	363
1-1090-02	V3199	Hydraulic cylinder 22 tonnes	333
1-1090-03	V3217	Hydraulic cylinder 14 tonnes	332
1011	V2928	Crank for brake disc	339
1012	V2927	Scraper	339
1030	V2847	Hydraulic foot pump	340, 360
1036	V2846	Hydraulic pump · pneumatic	340, 361
1062-01	V2857	Tool set for silent blocks VW · AUDI · SEAT · ŠKODA	379
1062-01-01	V3014	Dismounting/mounting washer	379
1062-01-02	V3015	Pressure pipe	379
1062-01-03	V3016	Mounting washer	379
1062-01-04	V3017	Dismounting washer	379

Wallmek-No	VIGOR No.	Designation	Page
1064	V2922	Sliding hammer 5.2 kg	371
1066	V2871	Wheel hubs removal set for V2922	371
1068	V2872	Adapter for sliding hammer V2922	371
1068-04	V2851	Adapters for other tool systems	337
1068-05	V2910	Adapter 1/2" to G2-1/2" - 11	337
1068-06	V2850	Adapters for other tool systems	336
1068-08	V3869	Adapters for other tool systems	337
1068-10	V4220	Adapters for other tool systems	337
1086-6	V3018	Impact body · M 22x2.5 mm	333–334
1090-02-WAL	V2854	Tractive and compressive hydraulic cylinder 22 tonnes	333, 360–361, 366
1090-03	V2869	Hydraulic cylinder 14 tonnes	332
1090-14	V3256	Silent block bushing set · rear · BMW X5 · E53	379
1090-14-A6	V3302	Washer with thread · inside Ø 23 mm · suitable for M 22 spindle	379
1090-14-B6	V3019	Retaining ring	378–379
1090-14-D6	V3020	Mounting washer	378–379
1090-15-B	V3021	Pressure sleeve	378–379, 404
1090-15-B3	V3022	Retaining ring E32/E34	378
1090-15-C	V3023	Thrust washer	378–379
1090-15-D	V3024	Retaining washer E32 and E34	378
1090-18-D5	V3025	Mounting washer	378
1090-18-E5	V3026	Pressure pipe	378–379
1090-18-E6	V3027	Thrust washer	378–379
1090-20-02	V3033	Support disc Ø 32 mm · inside hole Ø 20.25 mm · suitable for spindle M 20	348, 371
1090-20-04	V3034	Support disc Ø 40 mm · inside hole Ø 20.25 mm · suitable for spindle M 20	348, 371
1090-20-06	V3035	Support disc Ø 45 mm · inside hole Ø 20.25 mm · suitable for spindle M 20	348, 371
1090-20-08	V3036	Support disc Ø 52 mm · inside hole Ø 20.25 mm · suitable for spindle M 20	348, 371
1090-20-M	V3060	Counterholder	342–343
1090-20-T10	V3063	Bearing washer Ø 63 mm · inside hole Ø 20.25 mm · suitable for spindle M 20	348
1090-20-T21	V3070	Bearing washer Ø 92 mm	343
1090-20-T22	V3071	Bearing washer Ø 95 mm · inside hole Ø 20.25 mm · suitable for spindle M 20	343
1090-22	V3072	Press frame for wheel hub removal	341
1090-25-10	V2864	Thrust washer · conical · universal	344, 348, 359
1090-25-11	V2861	Thrust washer (installation) VW · AUDI · SEAT · ŠKODA	350
1090-25-12	V2862	Thrust washer (installation) VW	350

Wallmek-No	VIGOR No.	Designation	Page
1090-25-13	V2863	Mounting ring FORD · MAZDA · Volvo	350
1090-25-14	V2859	Thrust washer (installation) FORD · MAZDA · Volvo	350
1090-25-15	V6824	Half shell set for assembling 92 mm compact wheel bearings	344
1090-26	V2845	Hub and bearing shell	341
1090-26-01	V3039	Thrust washer · large	341, 403
1090-26-02	V3040	Pressure pipe · large	341, 403
1090-30	V2849	Device for the removal of drive shafts · 4 and 5 holes	366, 370
1090-30-4	V3147	Axle drive shaft 4 holes · bolt circle 92 – 120 mm	370
1090-30-5	V3148	Axle drive shaft 5 holes · bolt circle 98 – 131 mm	370
1090-32	V3207	Set of drawbars, flange nuts and adapters	336
1090-39	V2886	Rear axle bushing tool set VW · AUDI · SEAT · SKODA	377
1090-39-06	V3213	Dismounting bushing	377
1090-39-08	V3214	Mounting bushing	377
1090-39-09	V3215	Assembly ring	377
1090-39-10	V3212	Dismounting ring	377
1090-54-01	V3045	Pressure sleeve	376
1090-54-02	V3046	Pressure sleeve	376
1090-54-03	V3047	Pressure sleeve	376
1090-54-04	V3048	Mounting bushing	376
1090-54-05	V3049	Dismounting ring	376
1090-54-06	V2915	Supporting joint dismounting bushing, MERCEDES-BENZ	376
1090-54-10	V2913	Supporting joint tool set MERCEDES-BENZ	376
1090-54-11	V2914	Stabilizer ball joint tool set MERCEDES-BENZ	376
1090-54-12	V2917	Control arm bushing set · rear · MERCEDES-BENZ	381
1090-54-12-001	V3050	Dismounting ring	381
1090-54-12-002	V3051	Mounting bushing	381
1090-54-12-003	V3052	Pressure pipe	381
1090-54-12-004	V3044	Retaining ring, installation	381
1090-55-C	V2858N	Press frame for changing supporting joints and ball joints of stabilizers	405
1090-60-01	V3053	Plate with thread	358, 374–375
1090-60-03	V3055	Support	374
1090-60-04	V3056	Screw · M 16x40 mm	358, 363, 374–375
1090-60-05	V3057	Open plate	374
1090-60-06	V3142	Adapter plate	374
1090-61-01	V2909	Pressure piece for supporting joint tool	374
1090-61-02	V2908	Pressure piece for supporting joint tool	374
1090-61-03	V2907	Pressure piece for supporting joint tool BMW E 36 outside	374

Wallmek-No	VIGOR No.	Designation	Page
1090-62-01	V2906	Pressure piece for supporting joint tool BMW E 30 · E 36 inside, MERCEDES-BENZ 124	374
1090-62-02	V2905	Pressure piece for supporting joint tool BMW E 30 · E 36 inside, MERCEDES-BENZ 124	374
1090-62-03	V2904	Pressure piece for supporting joint tool BMW E 30 · E 36 inside	374
1090-62-08	V2903	Pressure piece for supporting joint tool	374
1090-64-01	V2902	Pressure piece for supporting joint tool e.g. MERCEDES-BENZ 124	374
1090-66-01	V2901	Pressure piece for supporting joint tool	374
1090-66-03	V2900	Pressure piece for supporting joint tool VW LT35	374
1090-66-04	V2899	Pressure piece for supporting joint tool NISSAN Interstar · OPEL/VAUXHALL Movano · RENAULT Master	374
1090-66-05	V2898	Pressure piece for supporting joint tool for NISSAN Interstar · OPEL/VAUXHALL Movano · RENAULT Master · HYUNDAI Trajet · Santa Fé	374
1090-66-06	V2897	Pressure piece for supporting joint tool	374
1090-66-07	V2896	Pressure piece for supporting joint tool	374
1090-66-08	V2895	Pressure piece for supporting joint tool	374
1090-66-09	V2894	Pressure piece for supporting joint tool (removal)	374
1090-66-10	V2893	Pressure piece for supporting joint tool	374
1090-68-01	V2892	Pressure piece for supporting joint tool	374
1090-68-02	V2891	Pressure piece for supporting joint tool	374
1090-68-03	V3094	Pressure sleeve	–
1090-68-04	V3093	Pressure sleeve	–
1090-68-05	V3095	Pressure sleeve	–
1090-68-20	V2884	Rear axle bushing set RENAULT	–
1090-69-20-B	V5902	Rear axle bushing set	358, 377
1090-69-21	V3100	Dismounting/mounting bushing	377
1090-69-22	V3101	Mounting washer	377
1090-69-23	V3102	Retaining ring	377
1090-69-24	V3103	Thrust washer	377
1090-69-25	V5902-1	Mounting bushing	377
1090-69-26	V5902-2	Retaining ring	377
1090-69 1090-60-06	V2885	Press frame with open plate with adapter to close the plate	374
1091-10	V2879	Wheel bearing tool set · front, FORD	400
1091-10-04	V3088	Support disc · inside Ø 23 mm · suitable for M 22 spindle	399, 403
1091-11	V3087	Wheel hub tool	403
1091-15-01	V3090	Adapter ring	404
1091-17	V2889	Wheel bearing tool set · front · CITROËN · FIAT · PEUGEOT	398
1091-17-01	V3105	Pressure ring	398
1091-17-02	V3106	Thrust washer · Ø 170 mm	398–399, 402–403, 415

References Wallmek / VIGOR



Wallmek-No	VIGOR No.	Designation	Page
1091-17-03	V3107	Pressure pipe	398–399, 415
1091-17-04	V2881	Bearing washer for CITROËN · FIAT · PEUGEOT wheel bearing tool set · front · inside Ø 23 mm · suitable for M 22 spindle	398–399, 403
1091-17-05	V3108	Bearing washer · inside Ø 23 mm · suitable for M 22 spindle	398, 402–403
1091-17-06	V3109	Counterholder	398, 403
1091-17-07	V2882	Support disc for CITROËN · FIAT · PEUGEOT wheel bearing tool set · front	398, 403
1091-17-08	V3149	Pressure pipe	398–399, 402–403
1091-17-09	V3091	Support disc · inside Ø 23 mm · suitable for M 22 spindle	398, 403
1091-17-M22	V3092	Striker nut	334, 410
1091-18	V2883	Pressure ring for wheel bearing tool set · front · CITROËN · FIAT · PEUGEOT	398–399, 403
1091-23	V2888	Wheel bearing tool set · front · NISSAN · OPEL/VAUXHALL · RENAULT	399
1091-23-01	V3113	Pressure ring set Ø 89 mm	399
1091-23-02	V3112	Bearing shell	399
1091-23-03	V3110	Thrust washer · Ø 89 mm	399, 403
1091-23-04	V3111	Thrust washer	399
1091-24-001	V2951	Wheel bolt change tools for trucks · universal	–
1091-24-001-01	V3246	Mounting bushing	–
1091-24-001-02	V3245	Counterholder	–
1091-24-001-03	V3244	Dismounting pipe large Volvo · SMB	–
1091-24-001-04	V3243	Dismounting pipe small Volvo	–
1091-24-001-05	V3242	Dismounting bushing SCANIA	–
1091-24-001-06	V3241	Thrust rod · adjustable M 24	–
1091-24-001-08	V3239	Dismounting pipe BPW · ROR	–
1091-28	V2890	Drive shaft tool, 5 holes, for transport vehicles	401, 404
HSC 2008-1119	V4476-1	Adapter ring for OPEL/VAUXHALL Insignia	385
HSC2008-1118	V4354	Spring plate Ø 150 – 240 mm with locking element	385
HSC2018	V4476N	Hydraulic safety spring vice including 10 spring plates	382
HSC2018-1126	V4307N	Spring vice · hydraulic · universal	–
RES 1030-01	V3614	Gasket set	340
RES 1030-02	V3120	Hydraulic hose	340
RES 1090-01-09	V3123	Pressure foot M 24 x 3 mm	333

Wallmek-No	VIGOR No.	Designation	Page
RES 1090-01-10	V3124	Thrust rod · adjustable M 24	332–333
RES 1090-01-13	V3125	Protection ring for thread 1.1/2"	333
RES 1090-02-04	V3134	Pressure shaft M 24x3 mm	333
RES 1090-05-02	V3130	Thrust block · adjustable M 24	333–334
RES 1090-05-04	V3131	Protection ring for thread 2.5	334
RES 4305	V3012	CEJN fitting hydraulic · 1/8 inch	332
RES1090-01-12	V3129	Thrust block · adjustable M 24	333, 376
RES4009	V4596	Adapter · M 18 – M 22	–
RES4010	V3135	Adapter · M 22x2.5 – M 14x2.0	336, 378, 380–381
RES4011	V3219	Adapter · M 22x2.5 – M 12x1.75	336
RES4012	V3209	Adapter · M 22x2.5 – M 10x1.5	336
RES4014	V3210	Drawbar · M 10 · maximum 6 t	336
RES4015	V3220	Drawbar · M 12 · maximum 9 t	336
RES4016	V3136	Drawbar · M 14 · maximum 12 t	336, 378, 380–381
RES4021	V3137	Flange nut · M 14x2.0	336, 379–381
RES4022	V3208	Flange nut · M 12x1.75	336
RES4023	V3275	Flange nut · M 10x1.5	336
RES4024	V3126	Flange nut · M 18x2.5	333, 336, 338, 371, 414, 416
RES4025	V3132	Flange nut · M 22x2.5	334, 336, 368, 410
RES4026	V3127	Drawbar · M 18 M 22 · maximum 22 t	333, 336, 378–379, 414, 416
RES4027	V3133	Drawbar · M 22 · maximum 32 t	334, 336, 368–369
RES4028	V3138	Drawbar M 14	379
RES4029	V3139	Drawbar M 18 / M 22	378
RES4030	V3140	Drawbar M 18	371
RES4034	V3431	Drawbar · M 22	410, 415
RES4035	V4252	Flange nut M 27	334
RES4036	V4253	Drawbar · M 27 · maximum 50 t	334
RES4039	V4597	Adapter · M 27 – M 22	–
RES4304	V3141	(CEJN-) quick coupler connection	340
RES4306	V3128	(CEJN) fitting, hydraulic	332–334
RES4307	V6591	Adapter 3/8" outside thread · on CEJN / cylinder	337
RES4308	V6592	Adapter 3/8" inside thread · on CEJN / pump	337

V4481-X/466, EAN 4047728074674

VIGOR
SERIES **XL**

XL

466



V6394



V2393-S



V4586



V5170



V6015



V6650



V7015



44

Compartment for small pieces



63

VIGOR No.	Designation	EAN 4047728+
V4481-X-4	Compartment for small pieces · V4481-X	073639
V4481-XD-4	Compartment for small pieces · V4481-XD	073646

Pull-handle



66

VIGOR No.	Designation	EAN 4047728+
V4481-X-5	Handle · for tool trolleys · series XL · stainless steel	075619
V4481-XD-5	Handle · for tool trolleys · series XD	075602
V5489-5	Handle · for tool trolleys · series M	075626

Overview of New Products



Universal cover



66

VIGOR No.	Designation	EAN 4047728+
V6610-L	Universal cover · for series L	075732
V6610-XD	Universal cover · for series XD	075756
V6610-XL	Universal cover · for series XL	075749

Worktops



82

VIGOR No.	Designation	EAN 4047728+
V6000-01083-D	Wooden worktop · five-cornered	075039
V6000-01083-XD	Stainless steel worktop · five-cornered	075022
V6000-01357-D	Worktop, wood	073486
V6000-01357-XD	Worktop, stainless steel	073448
V6000-01725-D	Worktop, wood	073493
V6000-01725-XD	Worktop, stainless steel	073455
V6000-02036-D	Worktop, wood	073509
V6000-02036-XD	Worktop, stainless steel	073462
V6000-02588-D	Worktop, wood	073516
V6000-02588-XD	Worktop, stainless steel	073479
V6000-0676-D	Worktop, wood	075794
V6000-0676-XD	Worktop, stainless steel	075640
V6000-0861-D	Worktop, wood	075787
V6000-0861-XD	Worktop, stainless steel	075657

Perforated tool panel plates with power supply



83

VIGOR No.	Designation	EAN 4047728+
V6000-015SP	Perforated tool panel plates with power supply 861 mm	073998
V6000-05SP	Perforated tool panel plates with power supply 676 mm	073981

Supporting lower cabinets



78

VIGOR No.	Designation	EAN 4047728+
V6000-036	Supporting lower cabinets	073356
V6000-036XL	Supporting lower cabinets	073424

V6000-037, EAN 4047728075015

Bridge-type lower cabinet



78

Lower cabinet extension frame



79

VIGOR No.	Designation	EAN 4047728+
V6000-042	Lower cabinet extension frame	073363
V6000-042XL	Lower cabinet extension frame	073431

Screw jacks

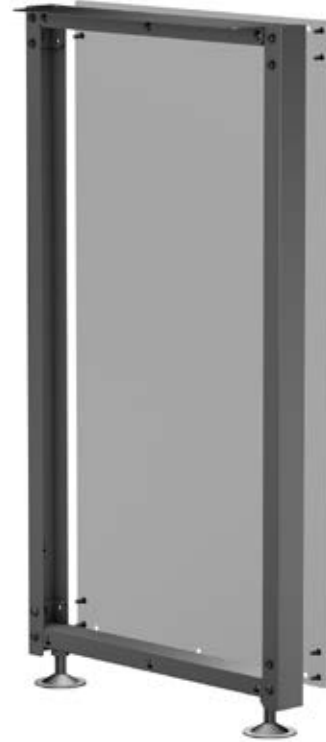

79

VIGOR No.	Designation	EAN 4047728+
V6000-044	Screw jacks	073325
V6000-044XL	Screw jacks	073370

Double hinged-door wall cabinet



80

VIGOR No.	Designation	EAN 4047728+
V6000-046	Double hinged-door wall cabinet	073615
V6000-046XL	Double hinged-door wall cabinet	073622

V6000-043, EAN 4047728073813

Base panel for lower cabinet with extension frame



85

V6000-050, EAN 4047728073417

Storage shelf



86

Overview of New Products



V6000-051, EAN 4047728073349
Can holder



86

V6000-052, EAN 4047728073653
Hanging rail



86

V6000-053, EAN 4047728074223
Visual storage box set



86

V6000-054, EAN 4047728074001
Monitor holder



87

V4700-A, EAN 4047728075077
Multibox expansion set



91

V7520, EAN 4047728075824
12-point socket set

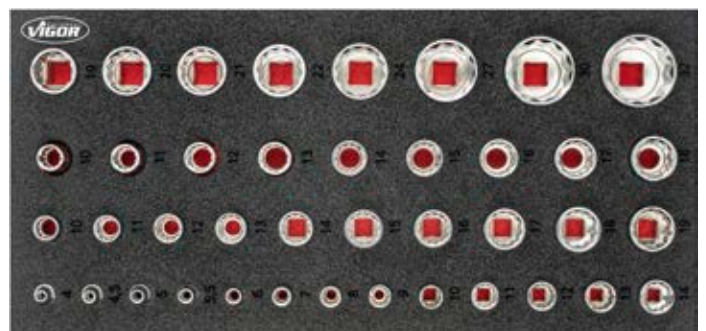

100

V6724, EAN 4047728067492
 Double open-end wrench,
 combination wrench, ratcheting
 combination wrench set



107

V6015, EAN 4047728074667
 Impact socket set



119

V7015, EAN 4047728074636
 Hammer, pliers and scraper
 set for Series XL



119

V7514/13, EAN 4047728074063
 12-point socket set

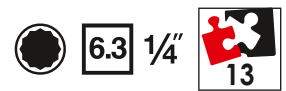

125

V7538/10, EAN 4047728074209
 12-point socket set

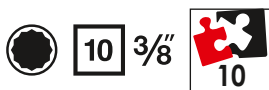

135

V7512/17, EAN 4047728074216
 12-point socket set

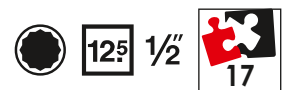

147

Overview of New Products



V4884-01, EAN 4047728073226
Ratchet head



155

V6611/4, EAN 4047728073561
Double ratcheting box-end wrench set



189

V4432/6, EAN 4047728073868
Screwdriver set · extra long

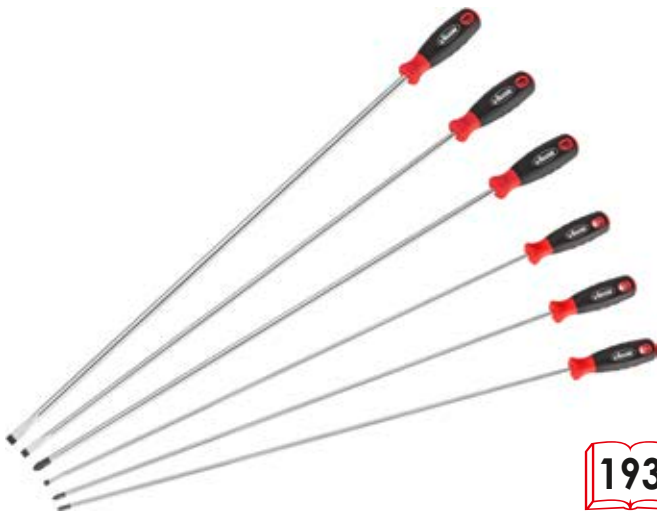

193

V4637N, EAN 4047728075565
Hose and spring band clamp pliers



208

V4737, EAN 4047728075572
Fuel line pliers



208

V4641, EAN 4047728075558
Clamp pliers



208

V5885, EAN 4047728**073851**
Clip loosening set



223

V2790N, EAN 4047728**075664**
Hack saw · small



225

V4800N, EAN 4047728**075633**
Impact wrench

125 1/2"



239

V4322, EAN 4047728**043229**
Underbody protection gun



245

Mini grease gun



245

Outside deburrer



258

VIGOR No.	Designation	EAN 4047728+
V6907	Mini grease gun	075497
V6907-1	High performance lubricant	075503

VIGOR No.	Designation	EAN 4047728+
V7402	Outside deburrer: 3 – 19 mm	074025
V7403	Outside deburrer: 13 – 35 mm	074032

Overview of New Products



V7548, EAN 4047728075480
Battery cell tester



264

V2459N, EAN 4047728075541
Refractometer



272

V4701, EAN 4047728073844
Mini vacuum pump



282

V7401, EAN 4047728074018
Brake disc thickness gauge · digital



295

V7471, EAN 4047728074711
Brake bleeding set



289

V6309, EAN 4047728075534
Impact socket set



305

V3657, EAN 4047728074520
Balance weight pliers



311

V7001, EAN 4047728075060
Universal rim lock removal set



315

V3551N, EAN 4047728075084
Plastic repair set



319

V7525, EAN 4047728075251
Universal pressing support



329

V5420, EAN 4047728075275
ROVER standard wheel bearing removal and installation set



346

V5903N, EAN 4047728075237
Wheel bearing puller



351

Overview of New Products



V7027, EAN 4047728075244
Wheel hub / bearing puller



355

V5169-A, EAN 4047728075381
Pressure sleeve expansion set



365

V5549-1N, EAN 4047728075909
Compact wheel bearing and wheel hub expansion set



396

V7252, EAN 4047728072526
Wheel bearing tool set · front · IVECO Daily 2014



400

V2858N, EAN 4047728075268
Press frame

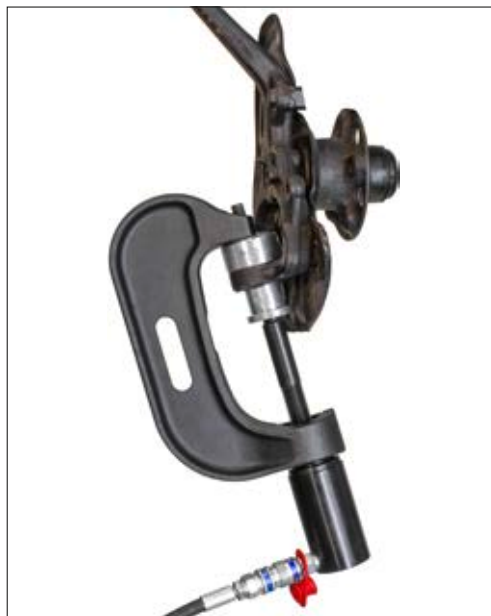

405

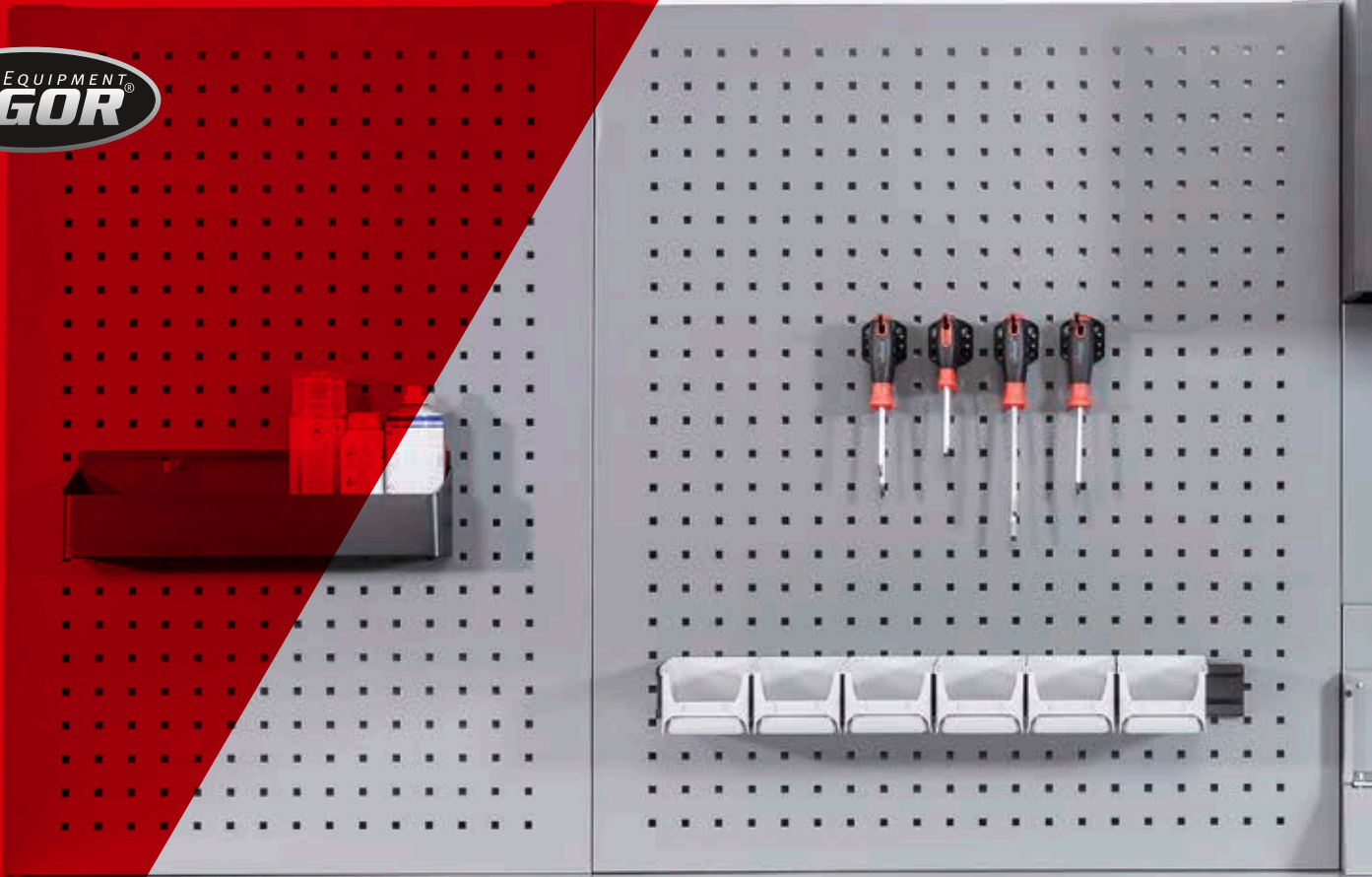

Tool trolleys and factory equipment

Tool trolleys with assortment 35–48

Mobile work benches with assortment 49–50

Tool trolleys without assortment 51–56

Mobile work benches without assortment 57–58

Service trolley 59

Accessories for tool trolleys 59–67

Storage system 68–80

Accessories for storage system 81–87



VIGOR No:	h x w x d mm	Total loading capacity kg	Worktop	Insert size	Insert dimension mm	Number of drawers	Loading capacity per drawer kg	Drawer slide-out	Drawer lock
V5489	1000x677x459	400	Removable foam mat	3/3+	563x393	7	20	100%	Central locking
V1902	375x723x459	/	/	3/3+	563x393	3	25	100%	Central locking
V1901	1000x723x459	500	Solvent resistant plastic material	3/3+	563x393	7	25	100%	Central locking
V1970	1375x723x459	500	Solvent resistant plastic material	3/3+	563x393	10	25	100%	Central locking
V4481	1000x907x481	500	Solvent resistant plastic material	4/3+	750x393	8	25	100%	Central locking
V4481-X	1017x940x514	500	Stainless steel worktop	4/3+	750x393	8	25	100%	Central locking
V4813	1000x1091x481	1000	Wooden worktop with collecting groove	3/3+	563x393	8	40	100%	Central locking
V4814	1000x907x481	1000	Wooden worktop with collecting groove	4/3+	750x393	4	40	100%	Central locking

Tool trolleys with assortment



V2379N, EAN 4047728055444



Tool trolley with assortment and mat



Drawer equipment variants

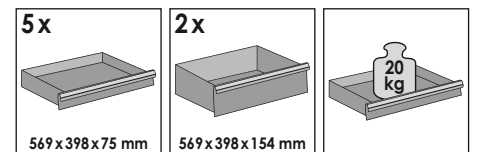
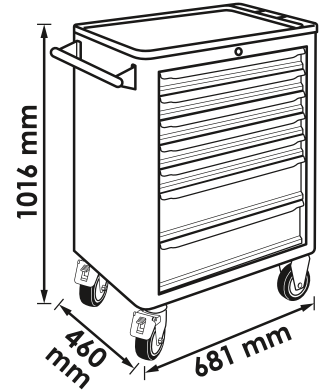

678.- €
excl. VAT

+ assortment

V5115



V6726

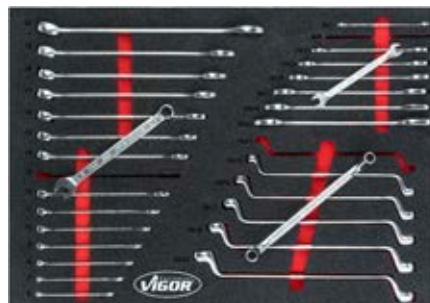

V5111



V2712N, EAN 4047728055451



Tool trolley with assortment and mat



Drawer equipment variants

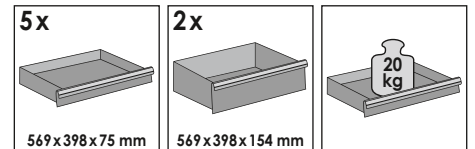
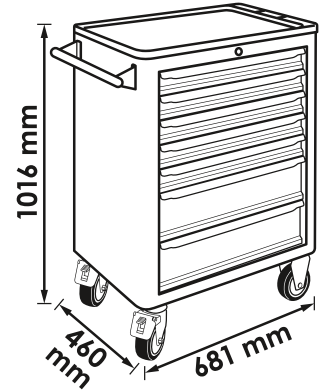

840.- € excl. VAT

+ assortment

V2837

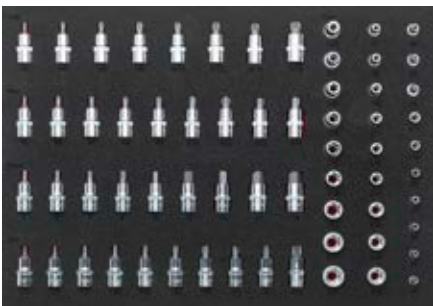

V6726

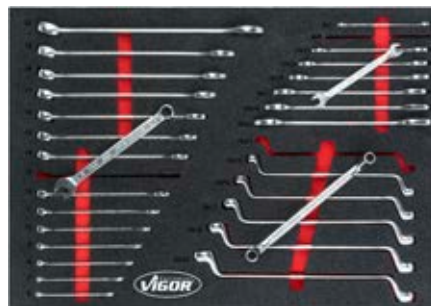

V5115



V5111



Tool trolleys with assortment



V4219, EAN 4047728042192



Tool trolley with assortment and plastic worktop

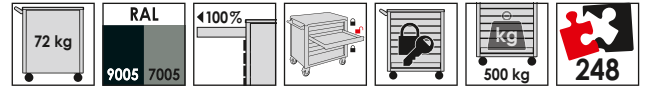

Drawer equipment variants

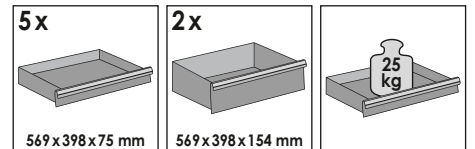
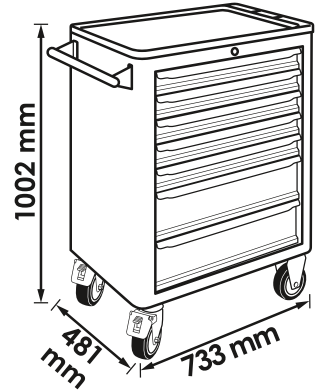

1,293.- € excl. VAT

+ assortment

V6643



V4188



V5634



V5055, EAN 4047728050562

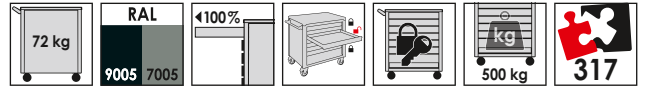

Tool trolley with assortment and plastic worktop



Drawer equipment variants

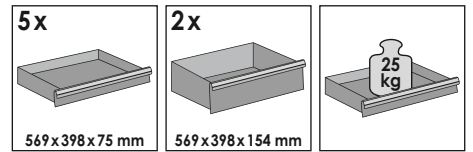
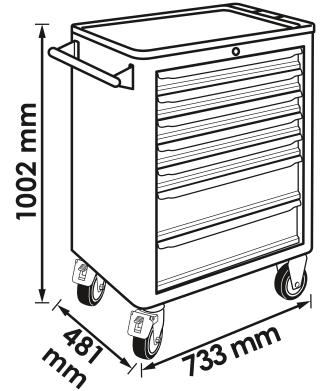

1,508.- € excl. VAT

+ assortment

V4188



V4753

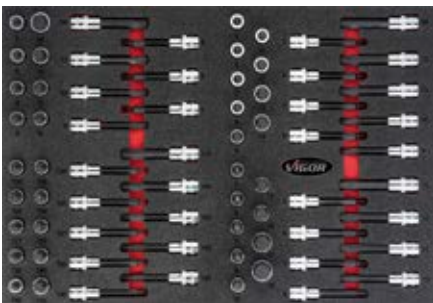

V6643



V5634



Tool trolleys with assortment



V4560, EAN 4047728045605



Tool trolley with assortment and plastic worktop

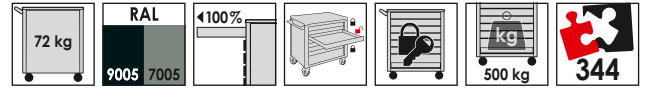

Drawer equipment variants

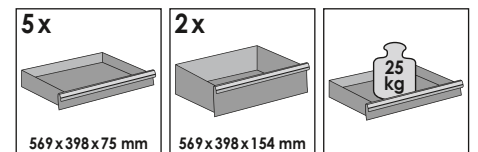
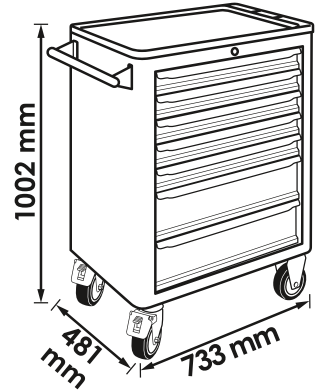

1,616.- € excl. VAT

+ assortment

V4188



V2837

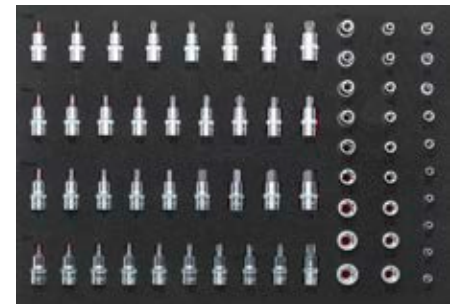

V4230



V5637



V6643



V4561, EAN 4047728045810

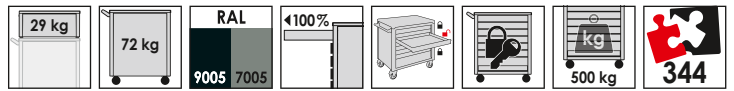

Tool trolley with assortment and tool chest



Drawer equipment variants

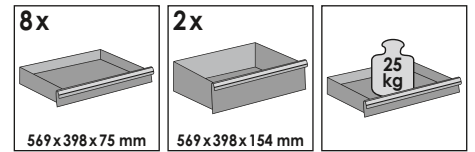
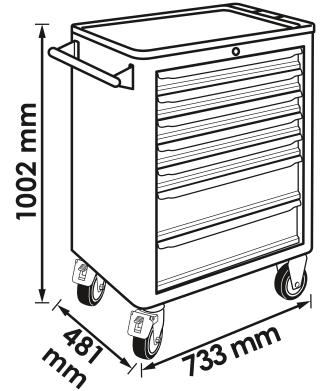

1,939.- €
excl. VAT

+ assortment

V4188



V2837

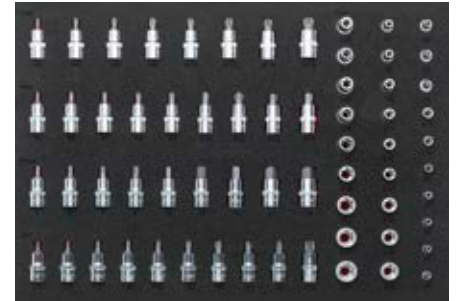

V4230



V6643



V5637



Tool trolleys with assortment



V4542, EAN 4047728045421



Tool trolley with assortment and plastic worktop

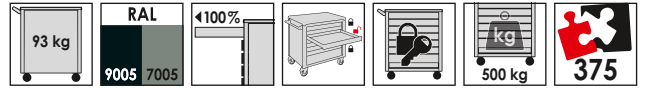

Drawer equipment variants

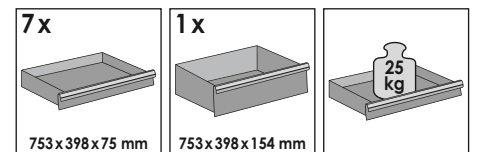
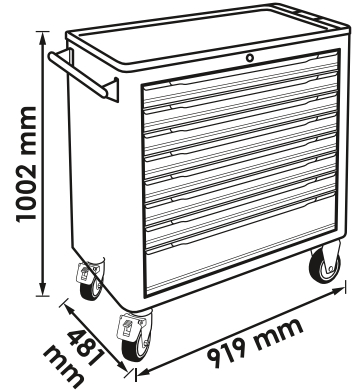

2,047.- € excl. VAT

+ assortment

V4586



V6650



V5170



V5638



V5434, EAN 4047728054348

VIGOR
SERIES **XL**

Tool trolley with assortment and plastic worktop

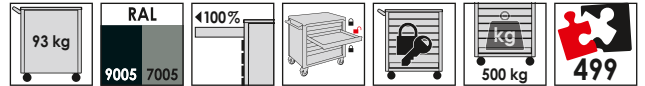

Drawer equipment variants

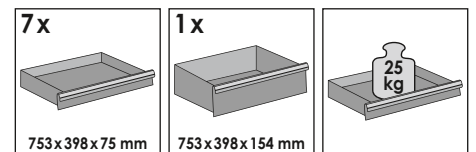
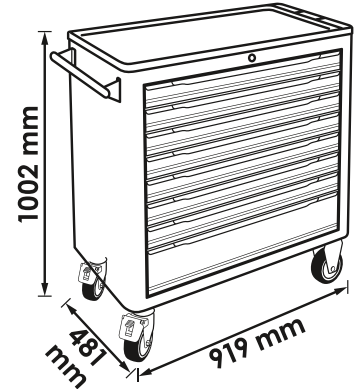

2,694.- €
excl. VAT

+ assortment

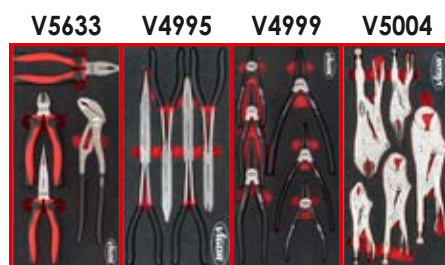
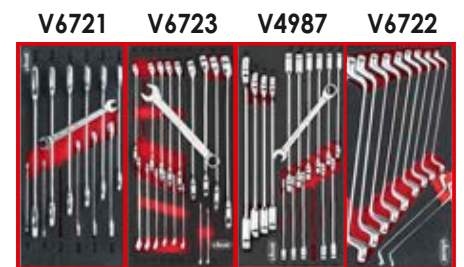
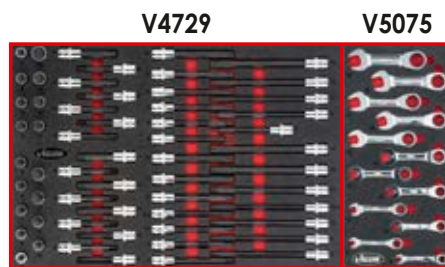
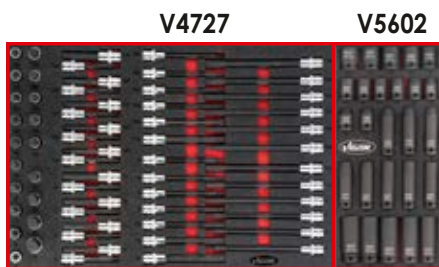

Tool trolleys with assortment



V4481-X/375, EAN 4047728062350



Tool trolley with assortment and stainless steel worktop

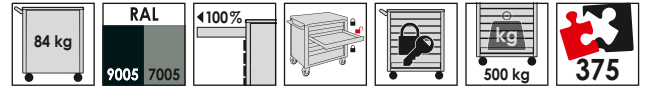

Drawer equipment variants

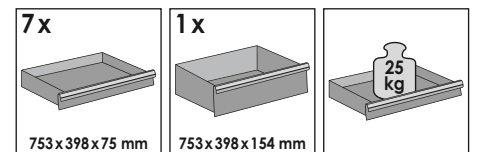
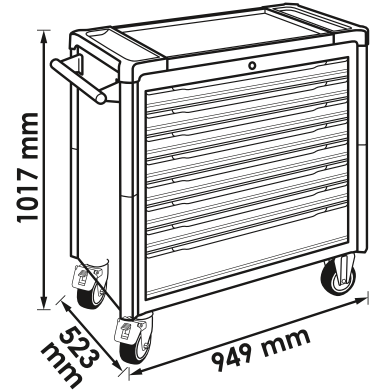

2,155.- € excl. VAT

+ assortment

V4586



V6650



V5170



V5638



V4481-X/466, EAN 4047728074674

VIGOR
SERIES **XL**

Tool trolley with assortment and stainless steel worktop

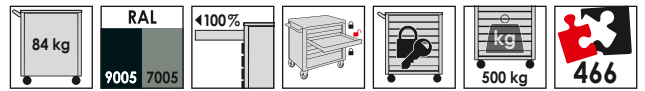

Drawer equipment variants



NEW

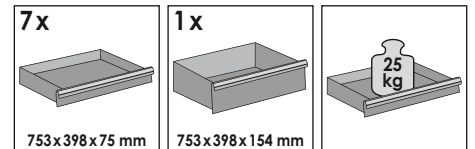
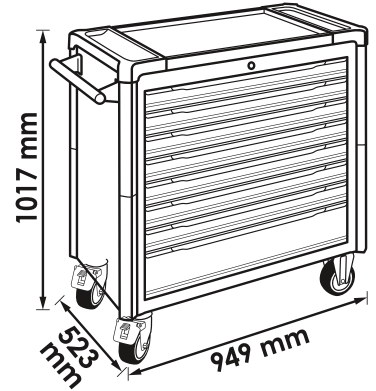

2,424.- €
excl. VAT

V6394



V2393-S



+ assortment

V4586



V5170



V6015



V6650



V7015



Tool trolleys with assortment



V4481-X/499, EAN 4047728062367



Tool trolley with assortment and stainless steel worktop

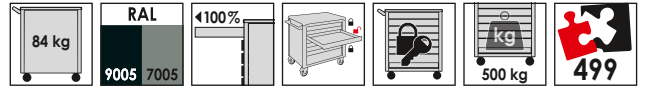

Drawer equipment variants

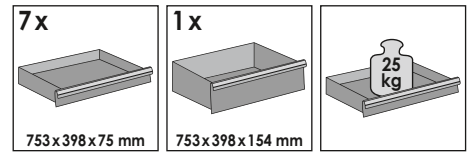
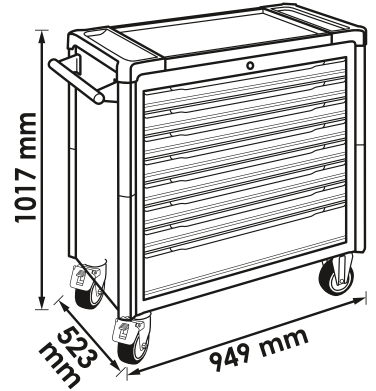

2,802.- € excl. VAT

+ assortment

V4971 V4973 V4975 V7323



V4727

V5602



V4729

V5075



V6721

V6723

V4987

V6722



V5170

V5633

V4995

V4999

V5004



V5006

V5017

V5070

V5072



V4497, EAN 4047728044974

VIGOR
SERIES **XL**

Tool trolley with basic assortment for VW and AUDI and stainless steel worktop

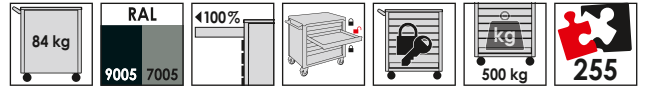

Drawer equipment variants

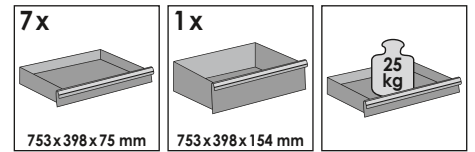
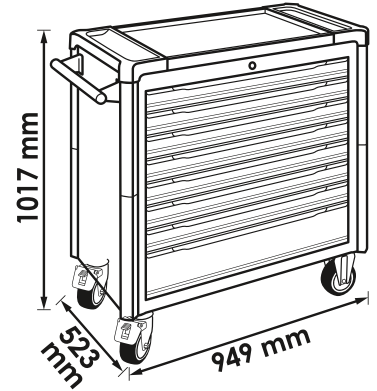

V4587



1,939.- €
excl. VAT

+ assortment

V4588



V5173



V6649



V6820

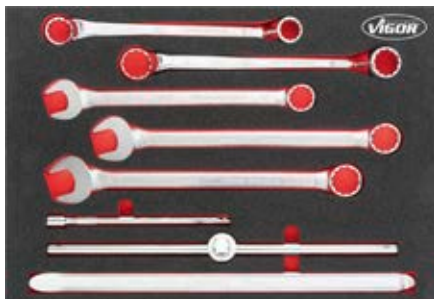

V5635



V4511



Tool trolleys with assortment



V4481-XD/469, EAN 4047728068512



V4481 - EXTRA DEEP

Extra-deep tool trolley with assortment and stainless steel worktop

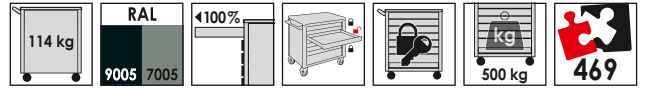

Drawer equipment variants

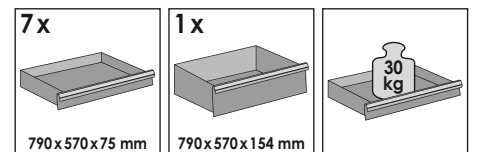
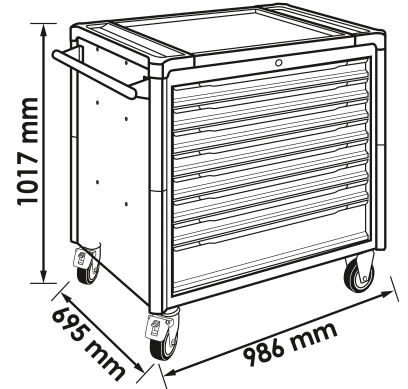

+ assortment

2,965.- € excl. VAT

V6821



V6822



V6807



V6808



V6813



V6814



V6815



V6816



V4481-XD/775, EAN 4047728068529

VIGOR SERIES XD

V4481 - EXTRA DEEP

Extra-deep tool trolley with assortment and stainless steel worktop

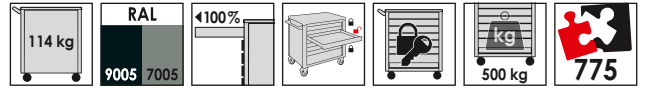

Drawer equipment variants

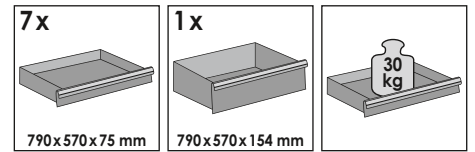
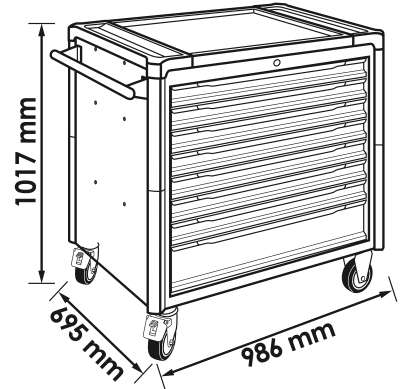

V6821

V6822

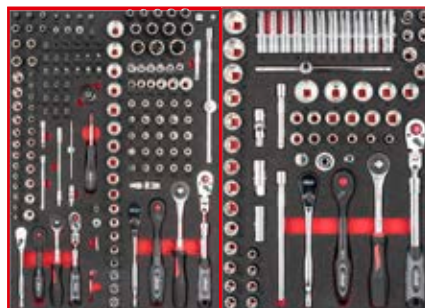

4,742.- €
excl. VAT

+ assortment

V6809

V6810

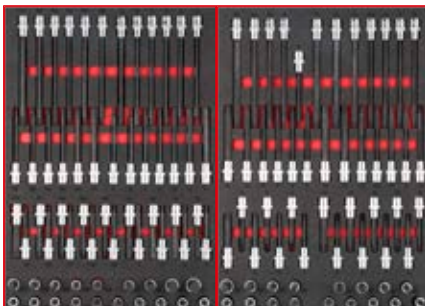

V6807

V6808

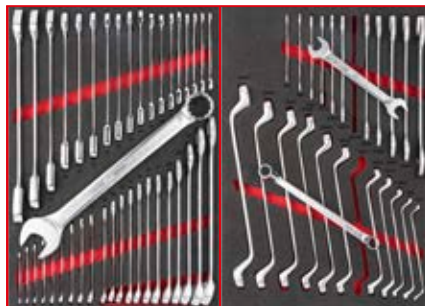

V6813

V6814



V6815

V6816

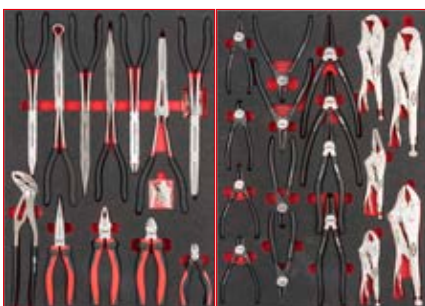

V6817

V6818

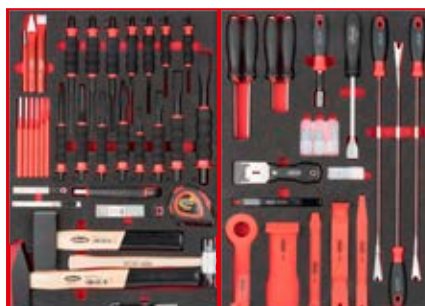

V6811

V6812

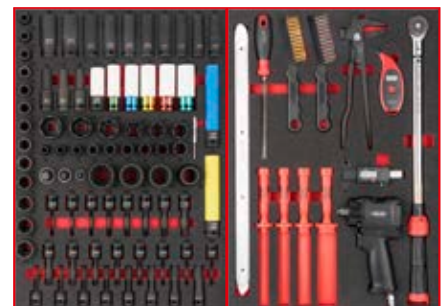

Mobile work benches with assortment



V5156, EAN 4047728051569



Mobile work bench with assortment

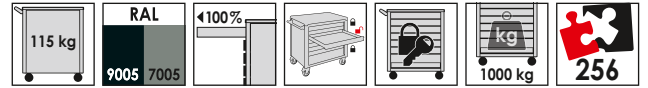

Drawer equipment variants

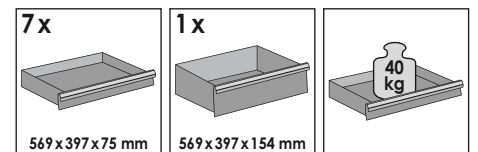
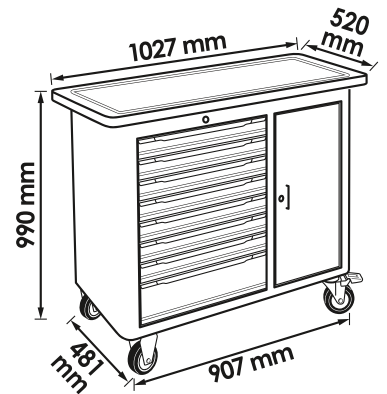

2,047.- € excl. VAT

Delivery without pull-handle

+ assortment

V6643



V4230



V5636



V4188



V5158, EAN 4047728051583



Mobile work bench with assortment

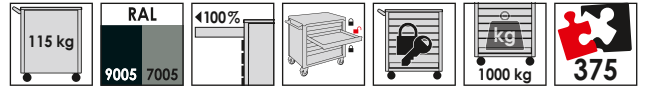

Drawer equipment variants

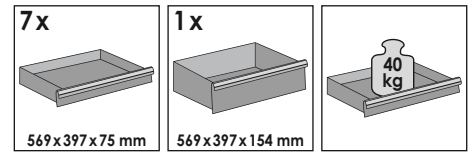
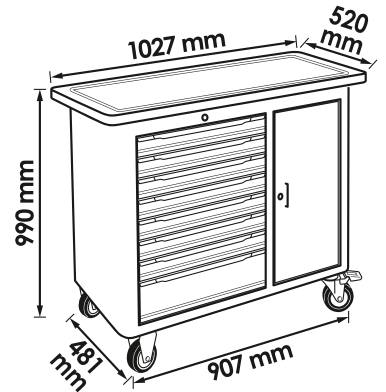

2,318.- €
excl. VAT

Delivery without pull-handle

+ assortment

V4188



V4727

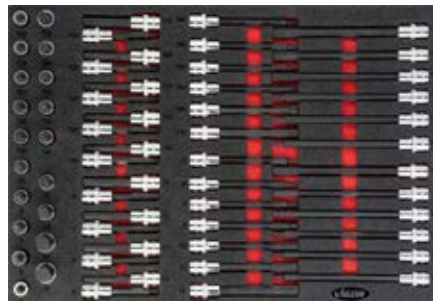

V4729



V6643



V4230



V5636



Tool trolleys without assortment



V5489, EAN 4047728054898



Tool trolley without assortment

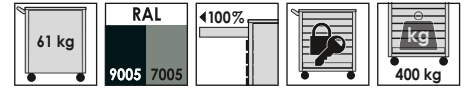

Drawer equipment variants

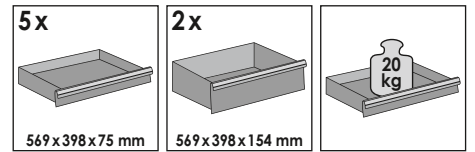
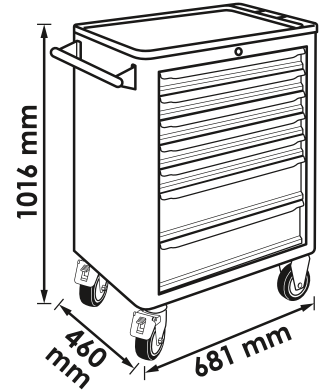

566.- €
excl. VAT

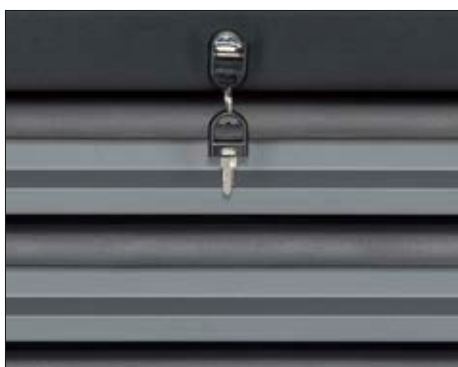
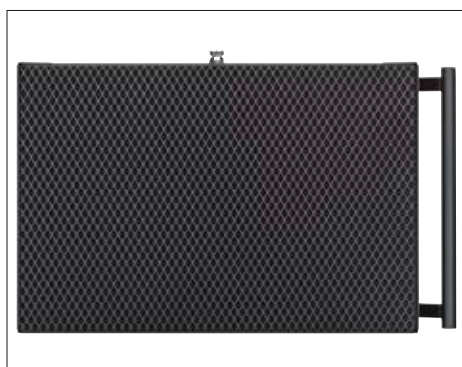

V1901, EAN 4047728019019



Tool trolley without assortment

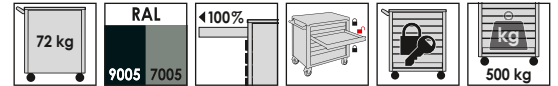

Drawer equipment variants

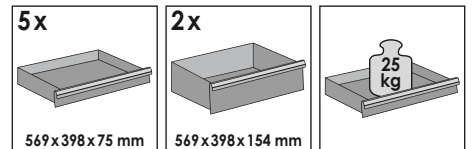
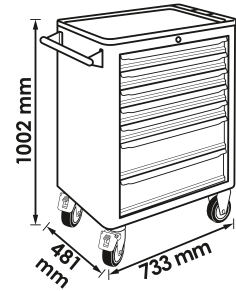

851.50 € excl. VAT

V1902, EAN 4047728019026



Tool chest for tool trolley V1901

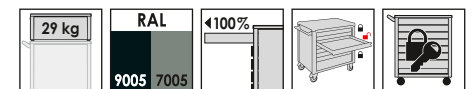

Drawer equipment variants

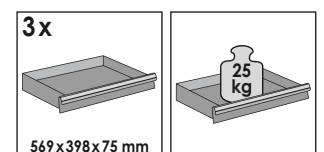
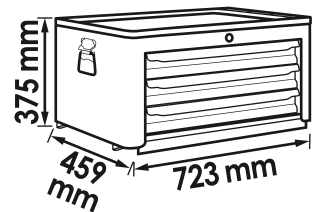

- Delivery without plastic cover, see V1909 -

430.- € excl. VAT

Tool trolleys without assortment



V1970, EAN 4047728019705



Tool trolley with tool chest, without assortment

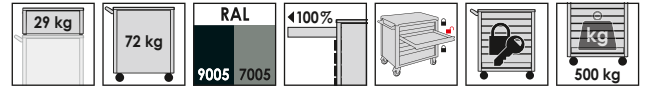

Drawer equipment variants

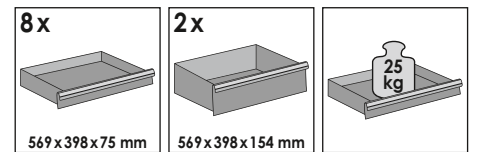
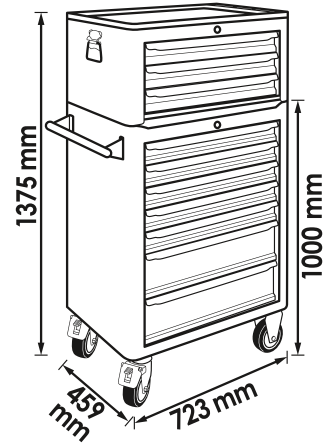

1,240.- € excl. VAT

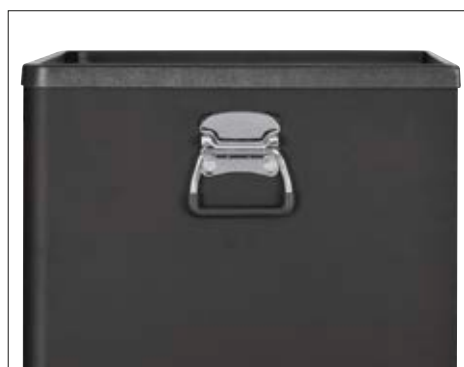

V4481, EAN 4047728044813

VIGOR
SERIES **XL**

Tool trolley without assortment, with plastic worktop

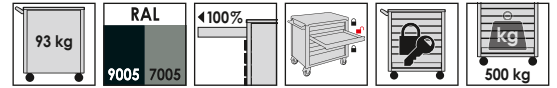

Drawer equipment variants

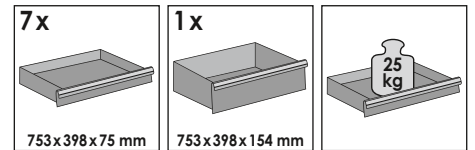
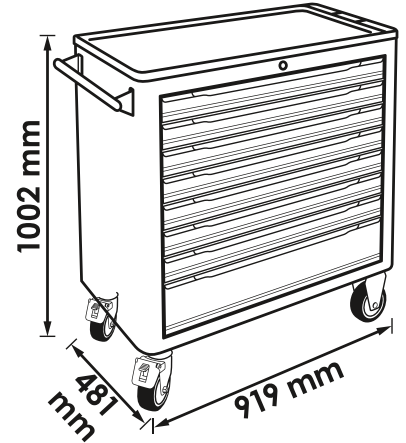

1,024.- €
excl. VAT



Tool trolleys without assortment



V4481-X, EAN 4047728060721



Tool trolley without assortment, with stainless steel worktop

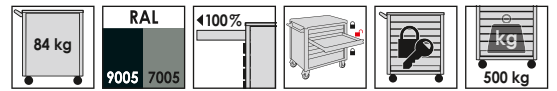

Drawer equipment variants

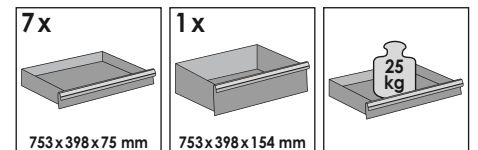
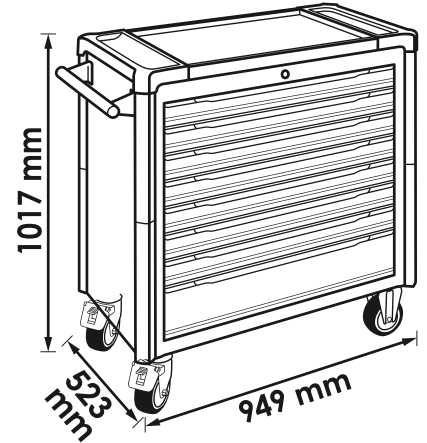

1,131.- € excl. VAT

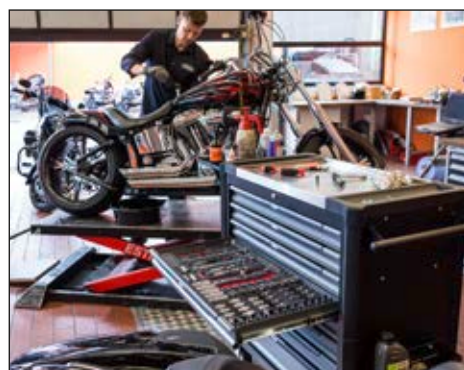

V4481-XD, EAN 4047728066488

VIGOR
SERIES **XD**

V4481 - EXTRA DEEP

Extra-deep tool trolley without assortment, with stainless steel worktop

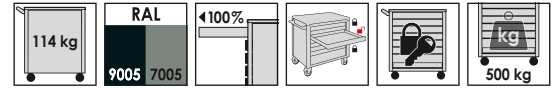

Drawer equipment variants

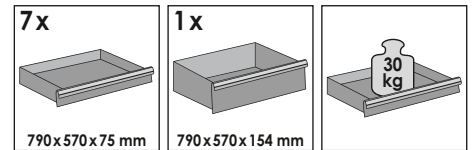
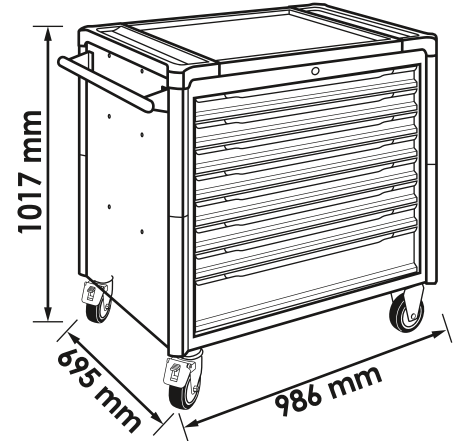

1,153.- €
excl. VAT



EXTRA DEEP

← V4481-XD = 695 mm →
← V4481-X = 523 mm →



Mobile work benches without assortment



V4814, EAN 4047728048149



Mobile work bench without assortment



Delivery without pull-handle

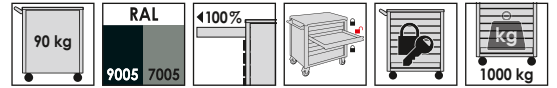

Drawer equipment variants

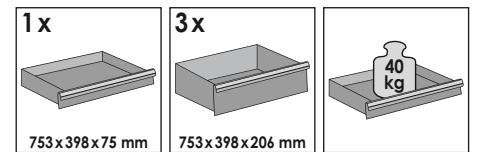
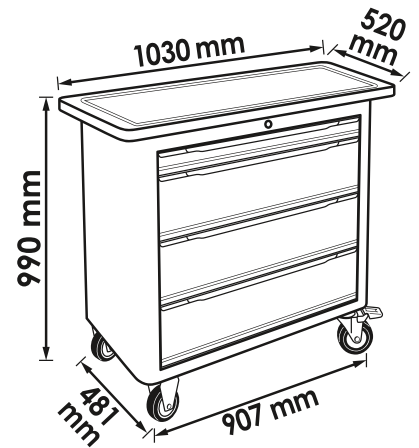

1,317.- € excl. VAT



V4813, EAN 4047728048132



Mobile work bench without assortment

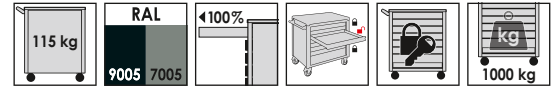

Drawer equipment variants

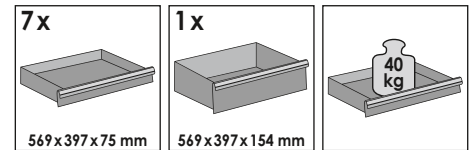
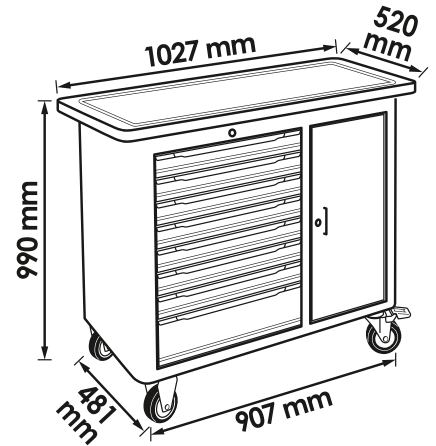

Delivery without pull-handle

1,374.- € excl. VAT



Service trolley Accessories for tool trolleys



V4758, EAN 4047728**047586**

Service trolley

- Robust sheet-steel design (1 mm strong intermediate plates and 1.5 mm strong angle elements)
- Middle level adjustable in height by 30 mm in 7 stages, for containers, for example
- Loading capacity per tray: 40 kg
- Large ball-bearing wheels (Ø 100 mm), 2 swivel castors, 2 fixed castors
- Easy manoeuvrability, even with high dynamic load
- Sturdy handle, firmly attached to the trolley's corpus
- Weight: 19 kg

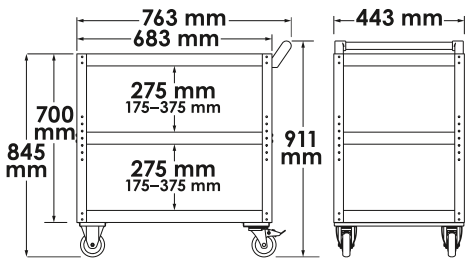

VIGOR No.	Designation	XX	EAN 4047728+	€
V5180	Swivel castor (pair) · for service trolley V4758	2	051804	17.25
V5191	Fixed castor (pair) · for service trolley V4758	2	051910	11.86

226.50 €
excl. VAT

V6398, EAN 4047728**071314**

Laptop holder · rotatable and pivotable

- Suitable for all series since 07/2019 → (with four screw sleeves)
- Pivotable and lockable
- 360° rotation
- Frontal and lateral edging protects the device from falling
- The work surface can be adjusted to the desired inclination
- Four additional holes for passing cables



75.35 €
excl. VAT



V6221, EAN 4047728062213

Laptop table

- Additional storage space for laptops, tablets, tools or motor vehicle components
- Suitable for all series
- Can be expanded and collapsed when installed
- Expansion of the tool trolley surface for better organisation and overview while working
- Locking element prevents unintentional folding of the table
- Maximum permitted loading capacity: 25 kg

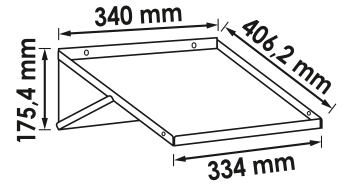

Screwed locking element

66.84 €
excl. VAT

V6395, EAN 4047728070522

Waste bin

- Disposal of waste or cloths
- Suitable for all series
- Also suitable for storing tools
- Capacity: 20 l

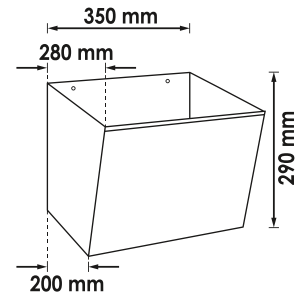

75.35 €
excl. VAT

V6396, EAN 4047728069601

Screwdriver holder

- Quick access to screwdrivers directly on the tool trolley
- Suitable for all series
- For 12 screwdrivers

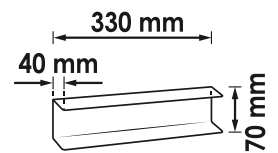

18.22 €
excl. VAT

V6394, EAN 4047728069595

Impact wrench holder

- Putting an impact wrench down directly on the tool trolley
- Suitable for all series since 07/2019→ (with four screw sleeves)
- Plastic edge protection prevents scratches when inserting the impact wrench
- Suitable for impact wrenches

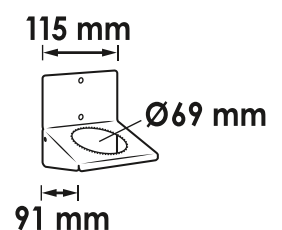

21.45 €
excl. VAT

Accessories for tool trolleys



V2397, EAN 4047728023979

Holder for paper reel

- Paper reels can be hung directly at the workplace
- Suitable for all series
- Paper reel not included
- Maximum width of paper reel: 370 mm

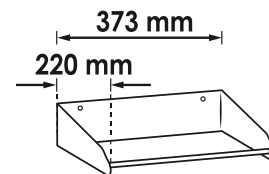

33.42 €
excl. VAT

V6397, EAN 4047728069793

Holder for paper reel · pivotable

- Paper reels can be hung directly at the workplace
- Suitable for all series
- Paper reel not included
- Maximum width of paper reel: 320 mm

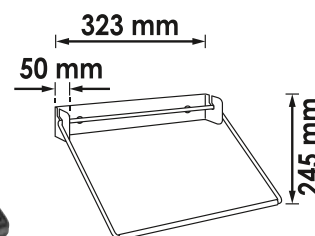

29.- €
excl. VAT

Document holder

- Storing of clipboards or order pockets directly at the workstation
- Suitable for all series
- Optimum storage of documents or workshop documents directly at the workplace

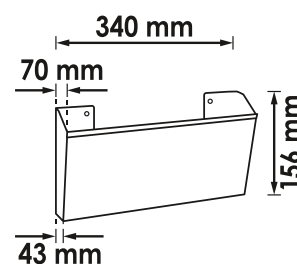

VIGOR No.	Designation	LxWxH mm	EAN 4047728+	€
V6393-S	Document holder · small · floor depth 43 mm	340x70x156	069205	39.78
V6393	Document holder · large · floor depth 100 mm	340x146x176	069519	46.25

Can holder

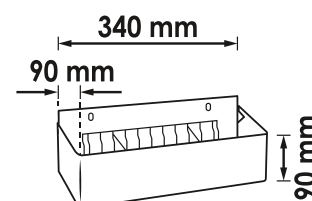

VIGOR No.	Designation	EAN 4047728+	€
V2393-S	Can holder · short · for all series · up to 4 cans	062046	32.23
V2393-XD	Can holder · extra long · for Series XD · up to 6 cans	067614	43.01





Separation sheet set

- Sorting of small parts in tool trolleys or storage system lower cabinets
- All four separation sheet sizes compatible with the separation sheet set
- Separation sheets can be inserted into each other thanks to asymmetrical punching
- Hot-dip galvanized surface prevents rust formation

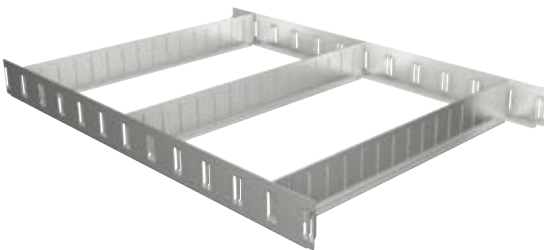

VIGOR No.	Designation		EAN 4047728+	€
V6688	Separation sheet set Series M and Series L	5	070249	25.33
V6688-XL	Separation sheet Series XL	6	070096	32.23
V6688-XD	Separation sheet Series XD	6	070089	35.04

Cross member set

- Hot-dip galvanized surface prevents rust formation



VIGOR No.	Designation		EAN 4047728+	€
V6687/5	Cross member set for Series XD	5	070072	28.57
V6686/5	Cross member set for Series M · Series L and Series XL	5	070065	26.41

Separation sheet set

- Compatible with all separation sheet sets and cross members
- For partitioning within a column

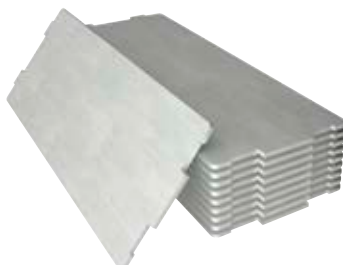

VIGOR No.	Designation		EAN 4047728+	€
V6685-1/20	Separation sheet set · small 45 mm	20	070133	24.69
V6685-2/20	Separation sheet set · medium 91 mm	20	070126	32.23
V6685-3/10	Separation sheet set · large 137 mm	10	070119	21.45
V6685-4/10	Separation sheet set · extra large 183 mm	10	070102	26.41

Accessories for tool trolleys



Compartment for small pieces

NEW



VIGOR No.	Designation	EAN 4047728+	€
V4481-X-4	Compartment for small pieces · V4481-X	073639	19.90
V4481-XD-4	Compartment for small pieces · V4481-XD	073646	24.90

Fixed castor



VIGOR No.	Designation		EAN 4047728+	€
V1907	Fixed castor · for tool trolleys Series M · Series L · Series XL · Series XD	1	019071	28.03
V4814-3	Fixed castor (pair) · for tool trolleys Series XL · Series XL Special and work benches	2	053044	58.21
V5191	Fixed castor (pair) · for service trolley V4758	2	051910	11.86

Swivel castor with locking brake



VIGOR No.	Designation		EAN 4047728+	€
V1908	Swivel castor · for tool trolleys Series M · Series L · Series XL · Series XD	1	019088	35.57
V4814-2	Swivel castor (pair) · for tool trolleys Series XL · Series XL Special and work benches	2	053037	72.23
V5180	Swivel castor (pair) · for service trolley V4758	2	051804	17.25

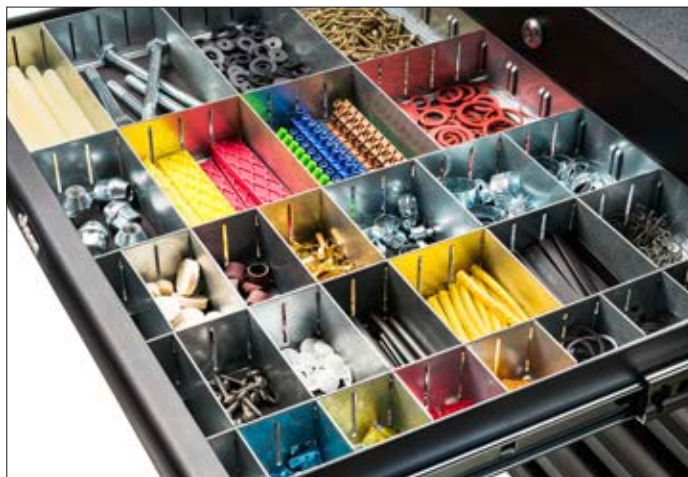

Drawer · flat



VIGOR No.	Designation	LxWxH mm	EAN 4047728+	€
V5489-4	Drawer · flat · 569x398x75 mm · for Series M	589x398x75	055413	55.41
V1905	Drawer · flat · 569x398x75 mm · for Series L · V1901 · V1902 · work bench V4813	589x398x75	019057	77.62
V4112	Drawer · flat · 753x398x75 mm · for Series XL · Series XL Special	753x398x75	041126	87.86
V4481-XD-2	Drawer · flat · for Series XD	790x570x75	067812	135.-

Drawer · high



VIGOR No.	Designation	LxWxH mm	EAN 4047728+	€
V5489-3	Drawer · high · 569x398x154 mm · for Series M	589x398x154	055307	66.51
V1906	Drawer · high · 569x398x154 mm · for Series L · V1901 · work bench V4813	569x398x154	019064	99.82
V4111	Drawer · high · 753x398x154 mm · for Series XL	753x398x154	041119	110.-
V4814-1	Drawer · high · 741x397x206 mm · for Series XL Special	741x397x206	053020	143.50
V4481-XD-3	Drawer · high · for Series XD	790x570x154	067829	160.50

Locking system



VIGOR No.	Designation	EAN 4047728+	€
V2462	Spare lock for all VIGOR tool trolleys and work benches	024624	16.71
V1904	Locking system for all Vigor work trolleys and work benches	019040	22.64

Guiding rails (pair)



VIGOR No.	Designation		EAN 4047728+	€
V1903	Guiding rails (pair) · for Series L · Series XL	2	019033	22.64
V5489-1	Guiding rails (pair) · for Series M	2	055284	14.98
V4481-XD-1	Guiding rails (pair) · for Series XD	2	067805	32.23

Accessories for tool trolleys



Worktop



VIGOR No.	Designation	EAN 4047728+	€
V1909	Worktop 723 x 459 mm · Plastic · for tool trolleys and worktops Series L	019095	48.51
V4122	Worktop 907 x 481 mm · plastic · for tool trolleys Series XL	041225	66.51

Worktop



VIGOR No.	Designation	EAN 4047728+	€
V4814-4	Worktop 1030 x 520 mm · wood · for mobile work benches series XL	053051	176.50
V4813-1	Worktop 1201 x 520 mm · wood · for tool trolleys series L	053013	176.50

V5489-2, EAN 4047728055291

Foam mat

- For tool trolleys Series M
- LxW: 670 x 450 mm



11.32 €
excl. VAT

V4813-2, EAN 4047728059268

Storage shelf

- For work bench VIGOR V4813
- LxW: 400 x 450 mm



33.20 €
excl. VAT



Universal cover

- Cover for tool trolleys, furniture or garden tools (suitable for indoor or outdoor use with roofing)
- Non-woven fabric (not moisture-proof, not suitable for washing machine, spot clean only)

NEW



Protects against dust and dirt when not used for a long time



VIGOR No.	Designation	LxWxH mm	EAN 4047728+	€
V6610-L	Universal cover · for series L	530 x 820 x 880	075732	22.50
V6610-XL	Universal cover · for series XL	720 x 1060 x 880	075749	22.50
V6610-XD	Universal cover · for series XD	540 x 1060 x 880	075756	22.50

Pull-handle

- Easy manoeuvring of tool trolleys and work benches
- Handle · for tool trolleys · series M

NEW



VIGOR No.	EAN 4047728+	€
V5489-5	075626	19.90

Pull-handle

- Easy manoeuvring of tool trolleys and work benches
- Handle · for tool trolleys · series L and series XL



VIGOR No.	EAN 4047728+	€
V4893	048934	25.01

Pull-handle

- Easy manoeuvring of tool trolleys
- Handle · for tool trolleys · series XL · stainless steel

NEW



VIGOR No.	EAN 4047728+	€
V4481-X-5	075619	24.90

Pull-handle

- Easy manoeuvring of tool trolleys
- Handle · for tool trolleys · series XD

NEW



VIGOR No.	EAN 4047728+	€
V4481-XD-5	075602	27.50

Tool hook set

- Hanging of tools
- Use with tool cabinet V2532 and perforated tool panel plates V6000-05 · V6000-015
- Price per set

<table border="1"> <thead> <tr> <th>VIGOR No.</th> <th>mm</th> <th>EAN 4047728+</th> <th>€</th> </tr> </thead> <tbody> <tr> <td>V2517</td> <td>25</td> <td>025171</td> <td>24.79</td> </tr> </tbody> </table>	VIGOR No.	mm	EAN 4047728+	€	V2517	25	025171	24.79	<table border="1"> <thead> <tr> <th>VIGOR No.</th> <th>mm</th> <th>EAN 4047728+</th> <th>€</th> </tr> </thead> <tbody> <tr> <td>V2518</td> <td>100</td> <td>025188</td> <td>26.95</td> </tr> </tbody> </table>	VIGOR No.	mm	EAN 4047728+	€	V2518	100	025188	26.95	<table border="1"> <thead> <tr> <th>VIGOR No.</th> <th>mm</th> <th>EAN 4047728+</th> <th>€</th> </tr> </thead> <tbody> <tr> <td>V2519</td> <td>25</td> <td>025195</td> <td>28.03</td> </tr> </tbody> </table>	VIGOR No.	mm	EAN 4047728+	€	V2519	25	025195	28.03	<table border="1"> <thead> <tr> <th>VIGOR No.</th> <th>mm</th> <th>EAN 4047728+</th> <th>€</th> </tr> </thead> <tbody> <tr> <td>V2520</td> <td>100</td> <td>025201</td> <td>34.50</td> </tr> </tbody> </table>	VIGOR No.	mm	EAN 4047728+	€	V2520	100	025201	34.50
VIGOR No.	mm	EAN 4047728+	€																																
V2517	25	025171	24.79																																
VIGOR No.	mm	EAN 4047728+	€																																
V2518	100	025188	26.95																																
VIGOR No.	mm	EAN 4047728+	€																																
V2519	25	025195	28.03																																
VIGOR No.	mm	EAN 4047728+	€																																
V2520	100	025201	34.50																																

V6150, EAN 4047728060691

Vice

- Rotary disc
- Powder coated
- Jaw length 150 mm (6 inch)
- Thread depth 68 mm
- Clamping force 2.5 tonnes
- ⚖️ 13.5 kg

150 mm

158 mm

23 mm

165 mm

Maximum clamping depth 125 mm

120° pivotable

90 x 90 mm

181 mm

380 mm

135.- € excl. VAT





Technical information



Insert dimensions narrow 563x393 mm

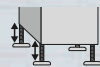

Feet adjustable in height to 50 mm



Insert dimensions wide 750x393 mm



The installation material is included in delivery



RAL colours 9005 · 7005



Central locking

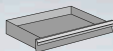

Narrow and flat drawer dimensions: 569x398x75 mm

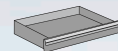

Wide and flat drawer dimensions: 753x398x75 mm

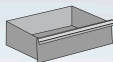

Narrow and high drawer dimensions: 569x398x154 mm

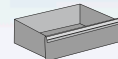

Wide and high drawer dimensions: 753x398x154 mm



Loading capacity of drawer: 25 kg



V6000-3P1

Storage System

- 3-module combination in wide design
- Available with wooden or stainless steel worktop
- Including side veneer

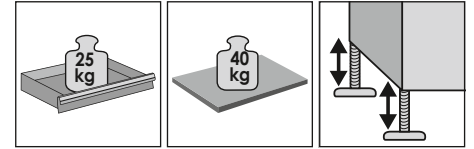
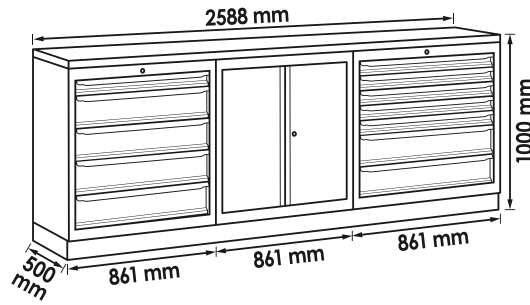

Starter kit



VIGOR No.	Designation	EAN 4047728+	€
V6000-3P1XL	Storage System combination · starter kit · wooden	073318	2,037.-
V6000-3P1XL-X	Storage System combination · starter kit · stainless steel	073271	2,145.-

All kits available with stainless steel or wooden worktops



V6000-3P2

Storage System

- 3-module combination in wide design with perforated panel structure and wall cabinets
- Available with wooden or stainless steel worktop
- Including side veneer

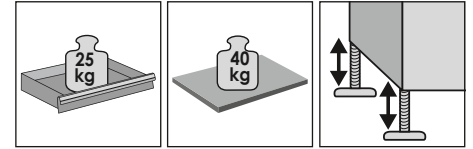
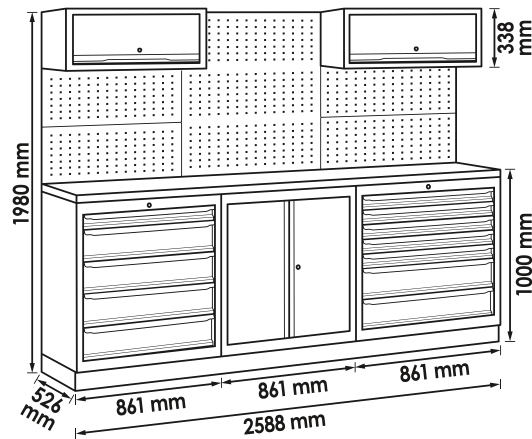

Complete kit



VIGOR No.	Designation	EAN 4047728+	€
V6000-3P2XL	Storage System combination · complete kit · wooden	073301	2,695.-
V6000-3P2XL-X	Storage System combination · complete kit · stainless steel	073295	2,857.-

V6000-3

Wall unit

- Cabinet door can be fitted on the right and left
- Cabinet door with magnetic lock
- Height-adjustable storage compartment
- All doors reinforced in the centre
- Simultaneous locking (equivalent to the Series L locking system)
- Drawer dimensions same as for Series L (569x398x75 mm flat drawer, 569x398x154 mm high drawer)
- Wall cabinets including high-quality shock absorbers
- Perforated tool panel for VIGOR tool hook sets V2517 · V2518 · V2519 · V2520

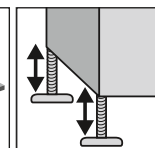
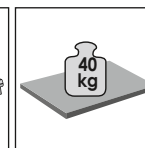
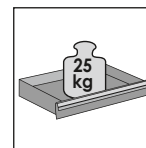
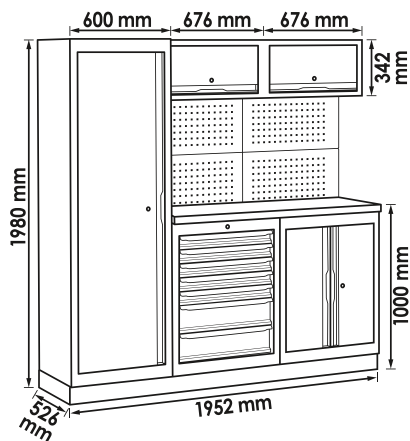

Compact kit



VIGOR No.	Designation	EAN 4047728+	€
V6000-3	Storage System combination · compact kit · wooden	048729	2,155.-
V6000-3-X	Storage System combination · compact kit · stainless steel	073288	2,210.-

V6000-030, EAN 4047728070140

Drawer lower cabinet · 3 drawers

- Setting up a stationary workstation
- Clean storage of tools, small parts or various consumables
- To save space and for tidy organisation, we recommend VIGOR separation sheets or soft foam inserts
- Similar to Series L
- Dimensions (HxWxD)
1st - 3rd drawer: 75 x 569 x 398 mm

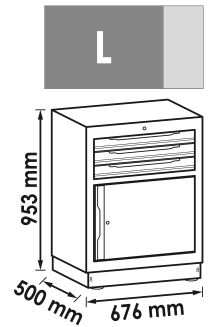

451.50 €
excl. VAT

V6000-030XL, EAN 4047728070294

Drawer lower cabinet · 3 drawers

- Setting up a stationary workstation
- Clean storage of tools, small parts or various consumables
- To save space and for tidy organisation, we recommend VIGOR separation sheets or soft foam inserts
- Similar to Series XL
- Dimensions (HxWxD)
1st - 3rd drawer: 75 x 753 x 398 mm

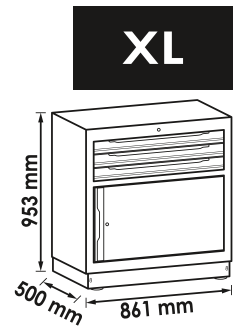

538.- €
excl. VAT

V6000-031, EAN 4047728070157

Drawer lower cabinet · 5 drawers

- Setting up a stationary workstation
- Clean storage of tools, small parts or various consumables
- To save space and for tidy organisation, we recommend VIGOR separation sheets or soft foam inserts
- Similar to Series L
- Dimensions (HxWxD)
1st drawer: 75 x 569 x 398 mm
2nd - 5th drawer: 154 x 569 x 398 mm

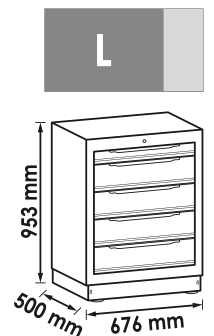

527.- €
excl. VAT

V6000-031XL, EAN 4047728070300

Drawer lower cabinet · 5 drawers

- Setting up a stationary workstation
- Clean storage of tools, small parts or various consumables
- To save space and for tidy organisation, we recommend VIGOR separation sheets or soft foam inserts
- Similar to Series XL
- Dimensions (HxWxD)
1st drawer: 75 x 753 x 398 mm
2nd - 5th drawer: 154 x 753 x 398 mm

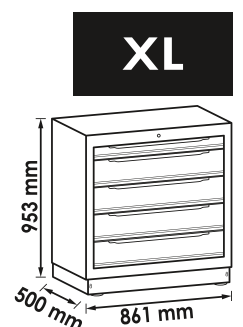

620.- €
excl. VAT

V6000-01, EAN 4047728048248

Drawer lower cabinet · 7 drawers

- Setting up a stationary workstation
- Clean storage of tools, small parts or various consumables
- To save space and for tidy organisation, we recommend VIGOR separation sheets or soft foam inserts
- Similar to Series L
- Dimensions (HxWxD)
1st - 5th drawer: 75x569x398 mm
6th - 7th drawer: 154x569x398 mm

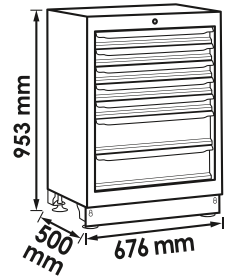

555.- €
excl. VAT

V6000-01XL, EAN 4047728070317

Drawer lower cabinet · 7 drawers

- Setting up a stationary workstation
- Clean storage of tools, small parts or various consumables
- To save space and for tidy organisation, we recommend VIGOR separation sheets or soft foam inserts
- Similar to Series XL
- Dimensions (HxWxD)
1st - 5th drawer: 75x753x398 mm
6th - 7th drawer: 154x753x398 mm

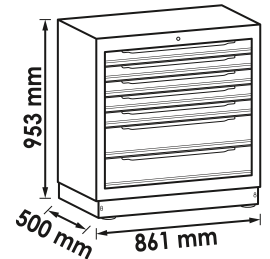

645.50 €
excl. VAT

V6000-019, EAN 4047728063883

Tool trolley for storage system · 7 drawers

- Space-saving storage of a tool trolley under the storage system worktop
- Especially for VIGOR storage system
- 4 swivel castors and special height for space-saving storage of the tool trolley after use under the storage system worktop
- Similar to Series L
- Dimensions (HxWxD)
1st - 5th drawer: 75x569x398 mm
6th - 7th drawer: 154x569x398 mm

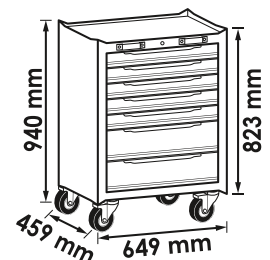

592.- €
excl. VAT

With 4 swivel castors



V6000-019XL, EAN 4047728070683

Tool trolley for storage system · 7 drawers

- Space-saving storage of a tool trolley under the storage system worktop
- Especially for VIGOR storage system
- 4 swivel castors and special height for space-saving storage of the tool trolley after use under the storage system worktop
- Similar to Series XL
- Dimensions (HxWxD)
1st - 5th drawer: 75x753x398 mm
6th - 7th drawer: 154x753x398 mm



XL

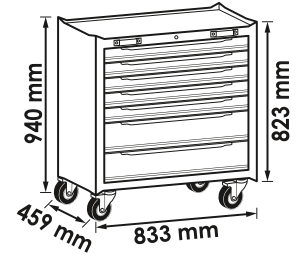

With 4 swivel castors

635.- €
excl. VAT

V6000-032, EAN 4047728070171

Drawer lower cabinet · 8 drawers

- Setting up a stationary workstation
- Clean storage of tools, small parts or various consumables
- To save space and for tidy organisation, we recommend VIGOR separation sheets or soft foam inserts
- Similar to Series L
- Dimensions (HxWxD)
1st - 7th drawer: 75x569x398 mm
8th drawer: 154x569x398 mm



L

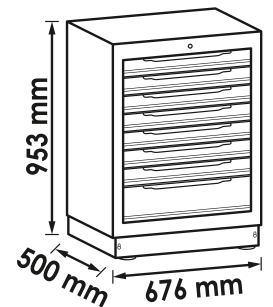

592.- €
excl. VAT

V6000-032XL, EAN 4047728070324

Drawer lower cabinet · 8 drawers

- Setting up a stationary workstation
- Clean storage of tools, small parts or various consumables
- To save space and for tidy organisation, we recommend VIGOR separation sheets or soft foam inserts
- Similar to Series XL
- Dimensions (HxWxD)
1st - 7th drawer: 75x753x398 mm
8th drawer: 154x753x398 mm



XL

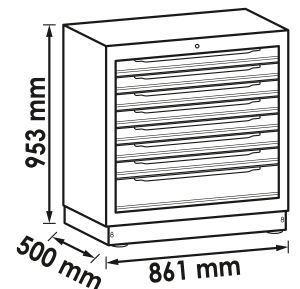

684.50 €
excl. VAT

V6000-033, EAN 4047728070195

Lower cabinet for waste

- Setting up a stationary workstation
- Waste separation directly at the workstation
- Waste bin securely and neatly positioned in the storage system module
- Lower cabinet with flap for rapid waste disposal
- Delivery including two waste bins
- Capacity of the waste bin: 35 l
- Similar to Series L

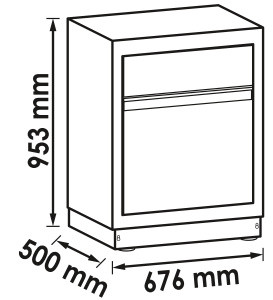

451.50 €
excl. VAT

V6000-033XL, EAN 4047728070331

Lower cabinet for waste

- Setting up a stationary workstation
- Waste separation directly at the workstation
- Waste bin securely and neatly positioned in the storage system module
- Lower cabinet with flap for rapid waste disposal
- Delivery including three waste bins
- Capacity of the waste bin: 1 x25 l · 2x35 l
- Similar to Series L

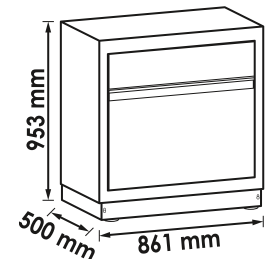

505.50 €
excl. VAT

V6000-02, EAN 4047728048255

Lower cabinet with double-hinged door

- Setting up a stationary workstation
- Storage of tool boxes, work clothes, containers or motor vehicle parts
- Hinged-door with magnetic lock
- Height-adjustable storage compartment
- Inside dimensions (LxWxH): 561 x466.4x561 mm
- Can be extended with additional V6000-018 storage shelves
- Similar to Series L

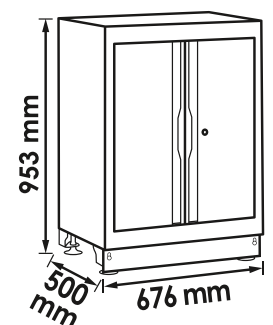
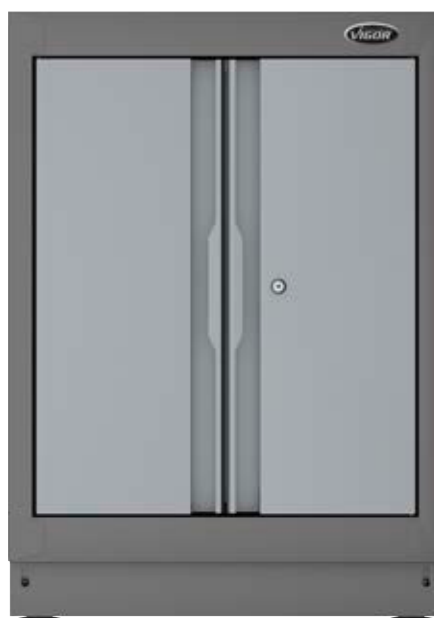

419.50 €
excl. VAT



V6000-02XL, EAN 4047728070355

Lower cabinet with double-hinged door

- Setting up a stationary workstation
- Storage of tool boxes, work clothes, containers or motor vehicle parts
- Hinged-door with magnetic lock
- Height-adjustable storage compartment
- Inside dimensions (LxWxH): 561 x 466.4x561 mm
- Can be extended with additional V6000-018XL storage shelves
- Similar to Series XL

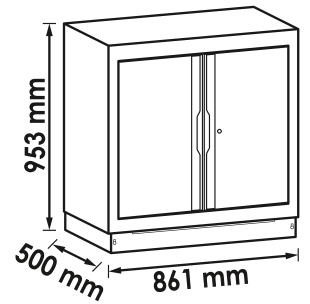

451.50 €
excl. VAT

V6000-011, EAN 4047728054904

Corner base cabinet

- Corner extension for additional lower cabinets
- For corner extension of the storage system line
- Including storage shelf

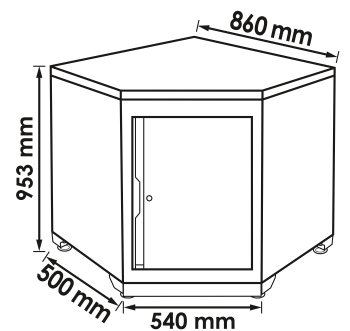

786.- €
excl. VAT



V6000-03, EAN 4047728048262

Cabinet with single-hinged door · high

- Storage of tool boxes, work clothes, containers or motor vehicle parts
- Cabinet door with magnetic lock
- Height-adjustable storage compartment
- Inside dimensions (LxWxH): 484x478x1503.3 / 220.5 mm
- Cabinet door can be fitted on the right and left
- Can be extended with V6000-017 storage shelves

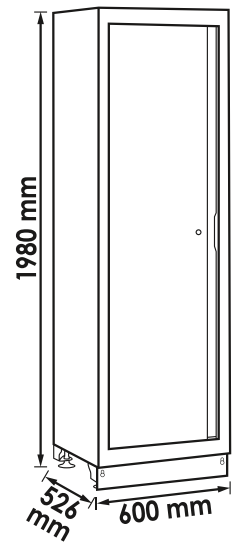

624.- €
excl. VAT

V6000-03XL, EAN 4047728070362

Cabinet with double-hinged door · high

- Storage of tool boxes, work clothes, containers or motor vehicle parts
- Cabinet door with magnetic lock
- Height-adjustable storage compartment
- Inside dimensions (LxWxH): 1119x510x1812 / 220.5 mm
- Cabinet door can be fitted on the right and left
- Can be extended with V6000-017XL storage shelves

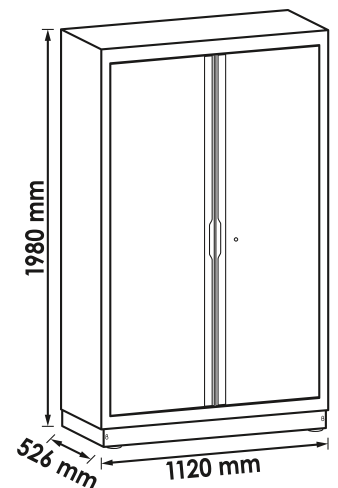

861.50 €
excl. VAT



V6000-037, EAN 4047728075015

Bridge-type lower cabinet

- Easy bridging of worktops – combines optimally with 500 mm deep worktops
- Creates much more workplace seating and more storage space in your workshop
- A high drawer and a large storage compartment for stowing the tools
- Loading capacity of drawer: 25 kg
- 4 feet adjustable in height (up to 50 mm)

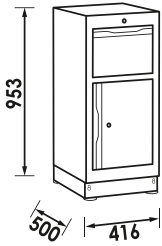

450.- €
excl. VAT

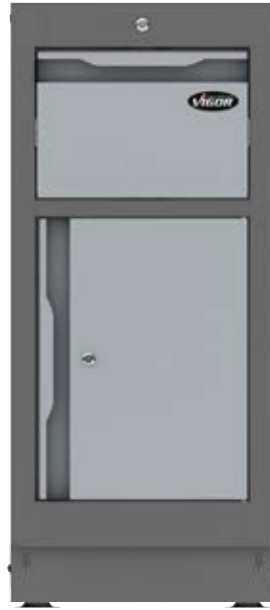

NEW

V6000-036, EAN 4047728073356

Supporting lower cabinets

- Adjustable height
- Base panels including in delivery
- Doors with magnetic lock
- 1 storage shelf included in delivery
- Slim design · 500 mm

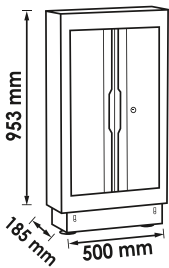

Perforated wall construction with supporting feet also possible

322.50 €
excl. VAT



NEW

V6000-036XL, EAN 4047728073424

Supporting lower cabinets

- Adjustable height
- Base panels including in delivery
- Doors with magnetic lock
- 1 storage shelf included in delivery
- Deep design · 700 mm

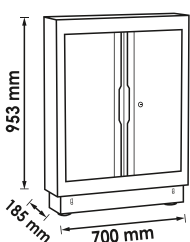

Perforated wall construction with supporting feet also possible

354.50 €
excl. VAT



NEW

V6000-042, EAN 4047728073363

Lower cabinet extension frame

- Extension of lower cabinet to a 700 mm working depth
- Enables installation of perforated tool panel and wall cabinet supports
- Extension frames are screwed to the back of a lower cabinet
- Slim design · 676 mm

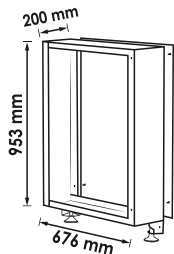

160.50 €
excl. VAT

NEW

V6000-042XL, EAN 4047728073431

Lower cabinet extension frame

- Extension of lower cabinet to a 700 mm working depth
- Enables installation of perforated tool panel and wall cabinet supports
- Extension frames are screwed to the back of a lower cabinet
- Wide design · 861 mm

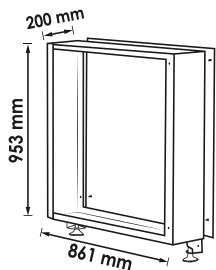

182.- €
excl. VAT

NEW

Screw jacks

- Adjustable height
- Privacy panel included in delivery

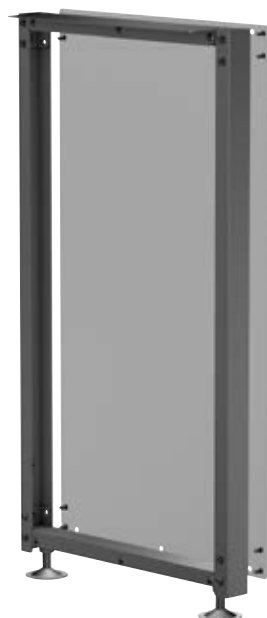

*Perforated wall construction
with supporting feet
also possible*

NEW



VIGOR No.	Designation	EAN 4047728+	€
V6000-044	Screw jacks	073325	139.10
V6000-044XL	Screw jacks	073370	160.70



V6000-046, EAN 4047728073615

Double hinged-door wall cabinet

- Combines optimally with 700 mm deep worktops
- Including 1 storage shelf adjustable in height
- Loading capacity of storage shelf: 15 kg
- Loading capacity of shelf base: 20 kg
- Hinged-door can be rotated to left or right hand stop
- Doors with magnetic lock

NEW

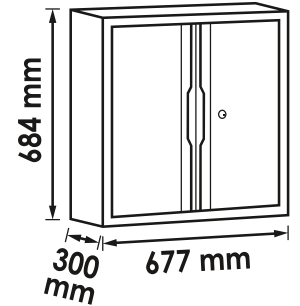

289.- €
excl. VAT

V6000-046XL, EAN 4047728073622

Double hinged-door wall cabinet

- Combines optimally with 700 mm deep worktops
- Including 1 storage shelf adjustable in height
- Loading capacity of storage shelf: 15 kg
- Loading capacity of shelf base: 20 kg
- Hinged-door can be rotated to left or right hand stop
- Doors with magnetic lock

NEW

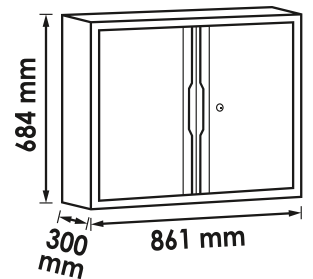

322.- €
excl. VAT

V6000-04, EAN 4047728048279

Wall cabinet

- Storage of tools, containers or motor vehicle parts

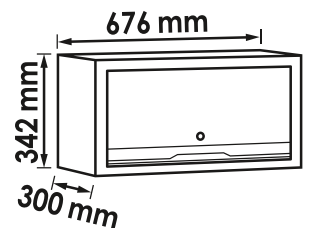

193.- €
excl. VAT

V6000-04XL, EAN 4047728070379

Wall cabinet

- Storage of tools, containers or motor vehicle parts

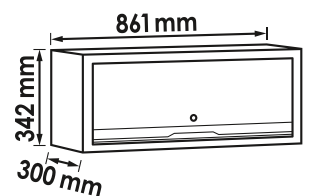

203.50 €
excl. VAT

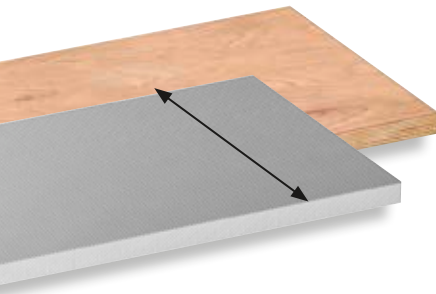

500mm



Worktop, wood

• Fixation on storage system lower cabinets



VIGOR No.	Designation	LxWxH mm	EAN 4047728+	€
V6000-0676	Wooden worktop · small	676 x 500 x 40	073028	167.-
V6000-0861	Wooden worktop · small	861 x 500 x 40	073042	188.50
V6000-01541	Wooden worktop combined · medium	1541 x 500 x 40	073141	344.-
V6000-01357	Wooden worktop · medium	1357 x 500 x 40	073066	275.-
V6000-01725	Wooden worktop · medium	1725 x 500 x 40	073080	333.-
V6000-02036	Wooden worktop · large	2036 x 500 x 40	073103	387.-
V6000-02215	Wooden worktop combined · large	2215 x 500 x 40	073165	441.-
V6000-02404	Wooden worktop combined · large	2404 x 500 x 40	073189	473.-
V6000-02588	Wooden worktop · large	2588 x 500 x 40	073127	473.-

Worktop, wood

VIGOR No.	Designation	LxWxH mm	EAN 4047728+	€
V6000-0860	Wooden worktop · five-cornered	883 x 500 x 40	073202	333.-

Worktop, stainless steel

• Fixation on storage system lower cabinets



VIGOR No.	Designation	LxWxH mm	EAN 4047728+	€
V6000-0676-X	Stainless steel worktop · small	676 x 500 x 40	073035	221.-
V6000-0861-X	Stainless steel worktop · small	861 x 500 x 40	073059	268.50
V6000-01541-X	Stainless steel worktop combined · medium	1541 x 500 x 40	073158	420.50
V6000-01357-X	Stainless steel worktop · medium	1357 x 500 x 40	073073	387.-
V6000-01725-X	Stainless steel worktop · medium	1725 x 500 x 40	073097	441.-
V6000-02215-X	Stainless steel worktop combined · large	2215 x 500 x 40	073172	555.-
V6000-02404-X	Stainless steel worktop combined · large	2404 x 500 x 40	073196	609.-
V6000-02036-X	Stainless steel worktop · large	2036 x 500 x 40	073110	555.-
V6000-02588-X	Stainless steel worktop · large	2588 x 500 x 40	073134	667.50

Worktop, stainless steel

VIGOR No.	Designation	LxWxH mm	EAN 4047728+	€
V6000-0860-X	Stainless steel worktop · five-cornered	883 x 500 x 40	073219	501.50



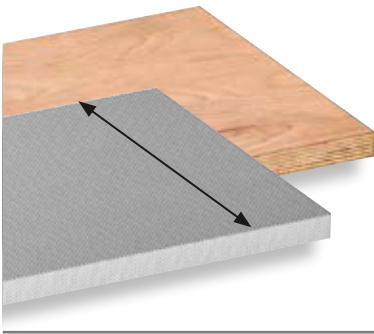

700mm



NEW



Worktop, wood

- Fixation on storage system lower cabinets

VIGOR No.	Designation	LxWxH mm	EAN 4047728+	€
V6000-0676-D	Worktop, wood	676 x 700 x 40	075794	207.-
V6000-0861-D	Worktop, wood	861 x 700 x 40	075787	244.50
V6000-01357-D	Worktop, wood	1357 x 700 x 40	073486	344.-
V6000-01725-D	Worktop, wood	1725 x 700 x 40	073493	408.50
V6000-02036-D	Worktop, wood	2036 x 700 x 40	073509	473.50
V6000-02588-D	Worktop, wood	2588 x 700 x 40	073516	646.-



Worktop, wood

VIGOR No.	Designation	LxWxH mm	EAN 4047728+	€
V6000-01083-D	Wooden worktop · five-cornered	1083 x 700 x 40	075039	530.-



Worktop, stainless steel

- Fixation on storage system lower cabinets

VIGOR No.	Designation	LxWxH mm	EAN 4047728+	€
V6000-0676-XD	Worktop, stainless steel	676 x 700 x 40	075640	365.-
V6000-0861-XD	Worktop, stainless steel	881 x 700 x 40	075657	398.-
V6000-01357-XD	Worktop, stainless steel	1357 x 700 x 40	073448	419.50
V6000-01725-XD	Worktop, stainless steel	1725 x 700 x 40	073455	505.50
V6000-02036-XD	Worktop, stainless steel	2036 x 700 x 40	073462	592.-
V6000-02588-XD	Worktop, stainless steel	2588 x 700 x 40	073479	781.50

NEW



Worktop, stainless steel

VIGOR No.	Designation	LxWxH mm	EAN 4047728+	€
V6000-01083-XD	Stainless steel worktop · five-cornered	1083 x 700 x 40	075022	680.-

Set of perforated tool panel plates

- Compatible with VIGOR tool hook sets

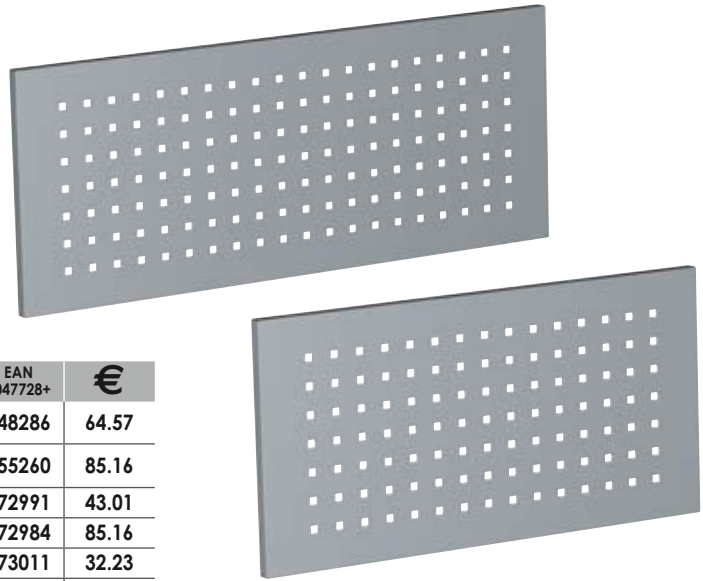

VIGOR No.	Designation		EAN 4047728+	€
V6000-05	Set of perforated tool panel plates · 676 x 342 mm	2	048286	64.57
V6000-015	Set of perforated tool panel plates · 861 x 338 mm	2	055260	85.16
V6000-015S	Perforated panel · 861 x 301 mm	-	072991	43.01
V6000-015SXL	Perforated panel · 861 x 985 mm	-	072984	85.16
V6000-05S	Perforated panel · 676 x 301 mm	-	073011	32.23
V6000-05SXL	Perforated panel · 676 x 985 mm	-	073004	64.57

Perforated tool panel plates with power supply

- Toggle switch for deactivating the power supply
- Only suitable for the lowest level
- Magnetic cover protects against soiling
- Integrated 3-way protective earth socket strip 230 V, 50/60 Hz
- 4 USB ports (4x 2.1 A)

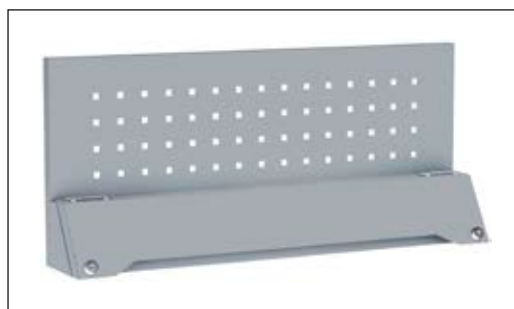

VIGOR No.	Designation	EAN 4047728+	€
V6000-05SP	Perforated tool panel plates with power supply 676 mm	073981	160.50
V6000-015SP	Perforated tool panel plates with power supply 861 mm	073998	182.-

Storage shelf



VIGOR No.	Designation		LxWxH mm	EAN 4047728+	€
V6000-017	Storage shelf set for single-hinged door cabinet V6000-03	2	524 x 476 x 13	055420	48.51
V6000-017XL	Storage shelf set for double-hinged door cabinet for V6000-03XL	2	1045 x 476 x 13	070669	102.50



Storage shelf

- Storage shelf for V6000-02 · V6000-02XL



VIGOR No.	Designation	LxWxH mm	EAN 4047728+	€
V6000-018	Storage shelf for double hinged door lower cabinet V6000-02	601 x 464 x 13	059275	45.17
V6000-018XL	Storage shelf for double hinged door lower cabinet	785 x 464 x 13	070652	64.57

V6000-06, EAN 4047728048293

Bracket for perforated plate · medium

- Attachment of perforated tool panel plates and wall cabinets
- Bracket for perforated plate · medium
- Bracket combines two lower cabinets on the rear
- Including screws
- Length: 1980 mm



37.73 €
excl. VAT

V6000-07, EAN 4047728048309

Perforated tool panel bracket set · left and right

- Attachment of perforated tool panel plates and wall cabinets
- Perforated tool panel bracket set · left and right
- Brackets are fastened to the outer position of the lower cabinets on the rear
- Including screws
- Length: 1980 mm

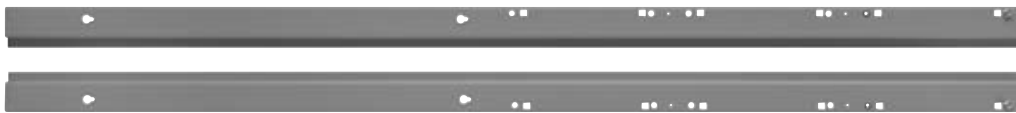

64.57 €
excl. VAT

V6000-010, EAN 4047728048439

Base panel for lower cabinets

- To neatly close off the side walls of all lower cabinets
- Prevents dust and dirt from getting in
- Delivery including screws



14.55 €
excl. VAT

V6000-043, EAN 4047728073813

Base panel for lower cabinet with extension frame

- To neatly close off the side walls of all lower cabinets with extension frame
- Prevents dust and dirt from getting in
- Delivery including screws
- Base panel · 650 mm

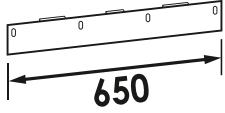

NEW

17.20 €
excl. VAT



V6000-09, EAN 4047728048422

Base panel for high cabinets

- To neatly close off the side walls of all high cabinets
- Prevents dust and dirt from getting in
- Delivery including screws

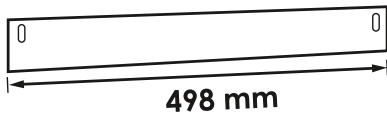

14.98 €
excl. VAT

V6000-040/4, EAN 4047728070645

Set of connection plates

- Rear connection of two lower cabinets
- Contents: 4 connection plates including screws and nuts

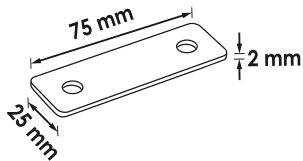

4

11.32 €
excl. VAT

V6000-041/4, EAN 4047728070676

Storage shelf support set

- For securing storage shelves

4



5.93 €
excl. VAT



V6000-053, EAN 4047728074223

Visual storage box set

- For storing small parts
- Combines optimally with V6000-052
- 3 visual storage boxes included in delivery
- Maximum load: 3 kg



10.70 €
excl. VAT

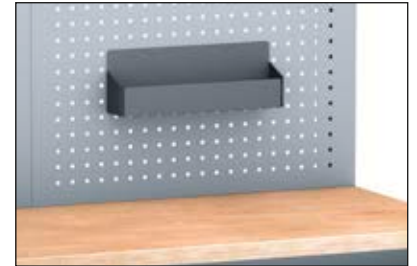
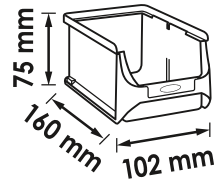

V6000-052, EAN 4047728073653

Hanging rail

- Only together with V6000-053
- For hanging a total of 6 visual storage boxes
- Simple hanging on 9 x 9 mm perforated tool panel grid



21.50 €
excl. VAT

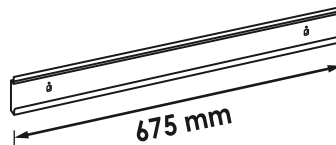

V6000-050, EAN 4047728073417

Storage shelf

- Simple hanging on 9 x 9 mm perforated tool panel grid
- Maximum load: 6 kg



37.70 €
excl. VAT

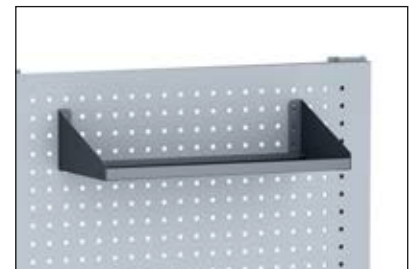
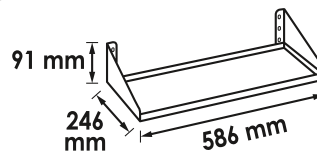

V6000-051, EAN 4047728073349

Can holder

- For storing cans
- Simple hanging on 9 x 9 mm perforated tool panel grid



21.50 €
excl. VAT

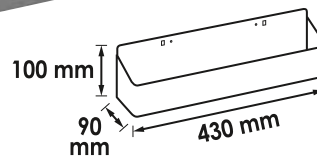

V6000-054, EAN 4047728074001

Monitor holder

- Cable routing on holder
- Holder plate and fixing material included in delivery
- Total outreach:
 - short swivel arm: 175 mm
 - long swivel arm: 265 mm
 - short and long combined: 350 mm
- Simple hanging on 9 x 9 mm perforated tool panel grid
- Maximum load: 5 kg
- 180° swivelling

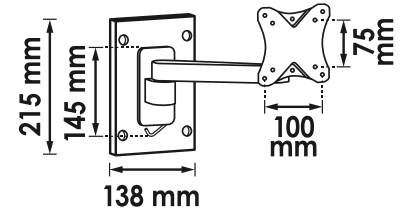
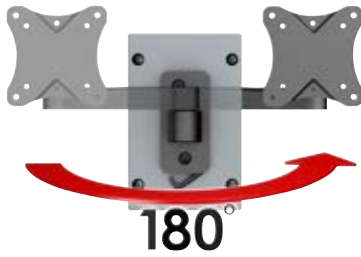

107.-€
excl. VAT

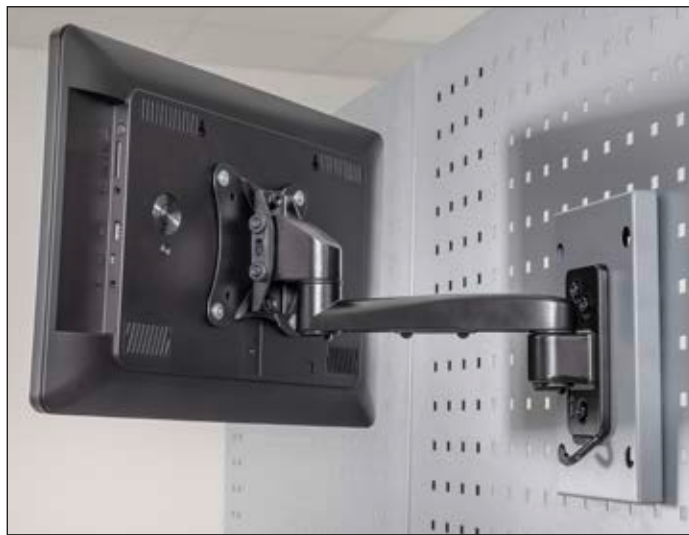

V6000-020, EAN 4047728069588

Spare lock for VIGOR storage system

- Including 2 keys
- For all VIGOR hinged-door cabinets: V6000-030 · V6000-030XL · V6000-02 · V6000-02XL · V6000-03 · V6000-03XL · V6000-011 · V6000-046 · V6000-046XL



16.06 €
excl. VAT



中

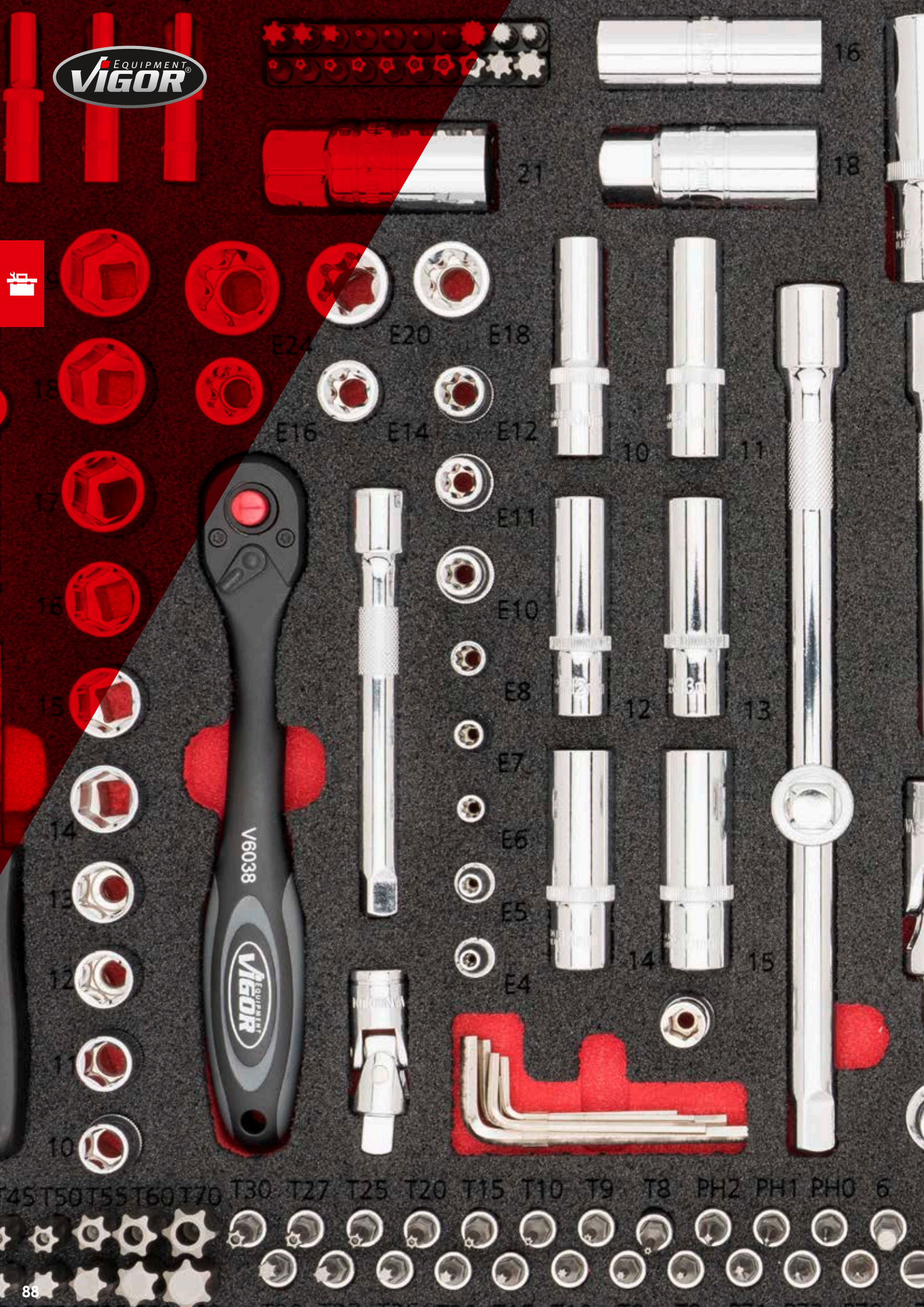

Tool storage

Multiboxes

90-91

Soft foam inserts

92-121

V4700-L, EAN 4047728**046794**

Multibox-L · empty

- Lightweight plastic box
- Maximum loading capacity: 90 kg

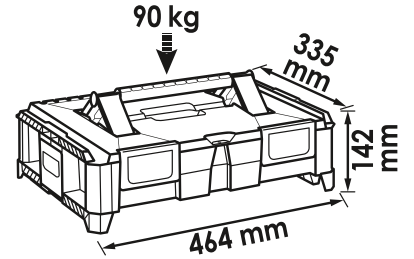

Internal dimensions:
 80 mm / 300 mm
 400 mm



59.29 €
excl. VAT



V4700-XL, EAN 4047728**049269**

Multibox-XL · empty

- Lightweight plastic box
- Maximum loading capacity: 90 kg

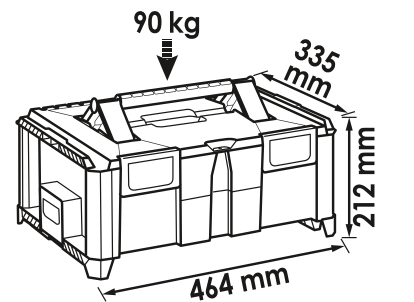

Internal dimensions:
 150 mm / 300 mm
 400 mm



70.07 €
excl. VAT

Multiboxes



V4700-XXL, EAN 4047728**049276**

Multibox-XXL · empty

- Lightweight plastic box
- Maximum loading capacity: 90 kg

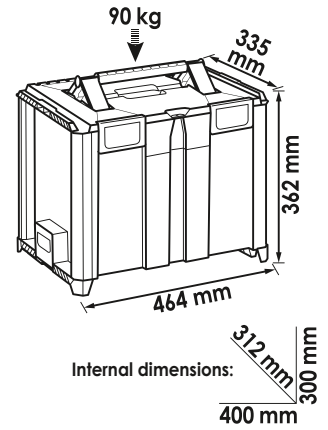

88.40 €
excl. VAT

V4700-A, EAN 4047728**075077**

Multibox expansion set

- For combining VIGOR multiboxes with third-party products
- Simple „click“ system for quick connections
- Multibox expansion set



NEW

12.90 €
excl. VAT

V4700-R, EAN 4047728**049283**

Mechanic's creeper for multibox

- Mechanic's creeper for V4700-L · V4700-XL and V4700-XXL
- Maximum loading capacity: 200 kg

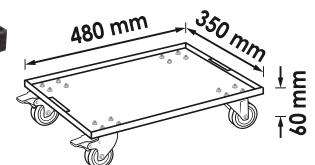

63.60 €
excl. VAT



Illustration of the drawer pictograms

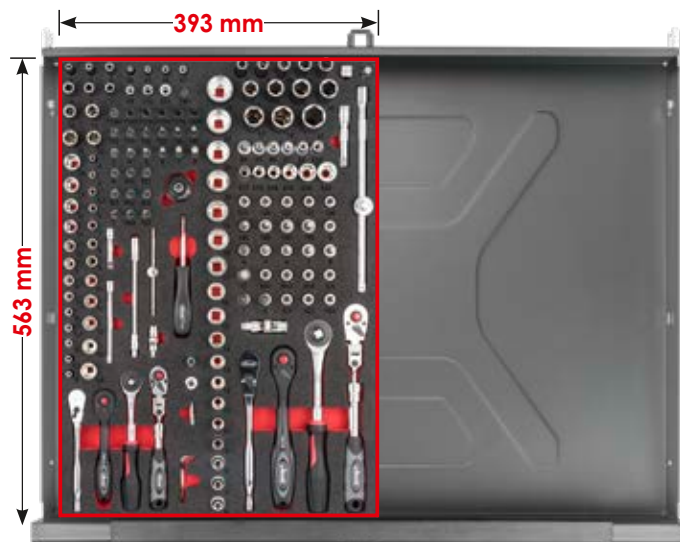
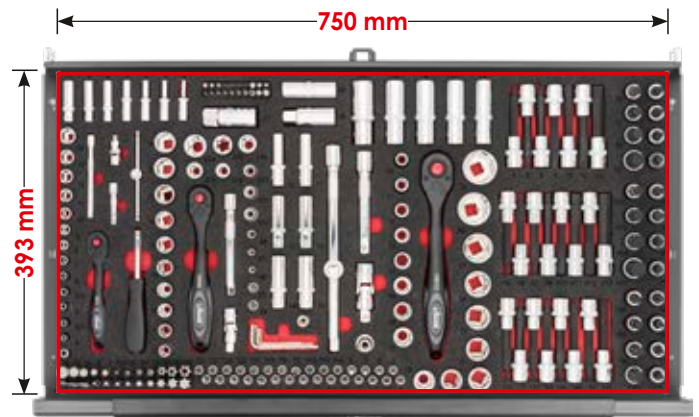
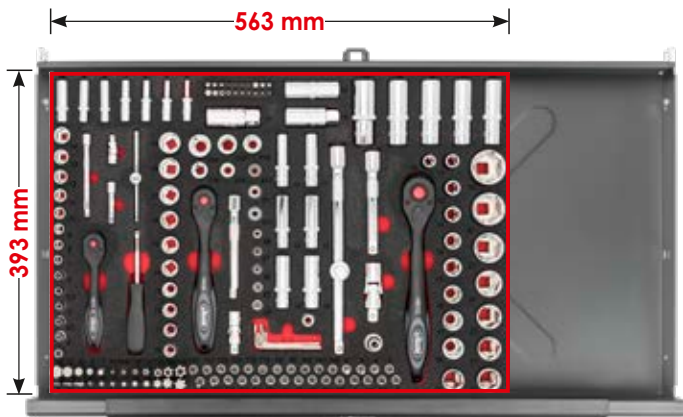
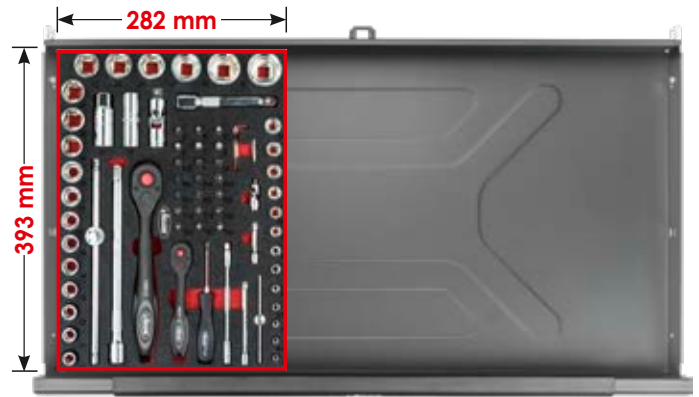

Soft foam inserts



V4971, EAN 4047728**049719**
Socket tool set



106.50 €
excl. VAT

XX	■		Design	Size
13 x	6.3	1/4		4 · 4.5 · 5 · 5.5 · 6 · 7 · 8 · 9 · 10 · 11 · 12 · 13 · 14 mm
7 x	6.3	1/4		4 · 5 · 6 · 7 · 8 · 9 · 10 mm
7 x	6.3	1/4		E4 · E5 · E6 · E7 · E8 · E10 · E11
6 x	6.3	1/4		3 · 4 · 5 · 6 · 7 · 8 mm
3 x	6.3	1/4		PH1 · PH2 · PH3
3 x	6.3	1/4		0.8x4-1x5.5-1.2x7 mm
3 x	6.3	1/4		PZ1 · PZ2 · PZ3
6 x	6.3	1/4		T10 · T15 · T20 · T25 · T30 · T40

XX	■		Design	Size
7 x	6.3	1/4		T9H · T10H · T15H · T20H · T25H · T27H · T30H
1 x	-	6.3		150 mm
1 x	6.3	1/4		40 mm
1 x	10	3/8		27 mm
1 x	6.3	1/4		110 mm
1 x	6.3	1/4		145 mm
1 x	6.3	1/4		50 mm
1 x	6.3	1/4		100 mm
4 x	-			1.3 · 1.5 · 2 · 2.5 mm
1 x	-	6.3		150 mm

V4971-L, EAN 4047728**049702**
Soft foam insert · empty

27.49 €
excl. VAT

V4973, EAN 4047728**049733**
Socket tool set



132.50 €
excl. VAT

XX	■		Design	Size
18 x	10	3/8		6 · 7 · 8 · 9 · 10 · 11 · 12 · 13 · 14 · 15 · 16 · 17 · 18 · 19 · 20 · 21 · 22 · 24 mm
10 x	10	3/8		8 · 9 · 10 · 11 · 12 · 13 · 14 · 15 · 17 · 19 mm
7 x	10	3/8		3 · 4 · 5 · 6 · 7 · 8 · 10 mm
3 x	10	3/8		0.8x5.5-1x7-1.2x8 mm
3 x	10	3/8		PH1 · PH2 · PH3
3 x	10	3/8		PZ1 · PZ2 · PZ3

XX	■		Design	Size
9 x	10	3/8		T15 · T20 · T25 · T27 · T30 · T40 · T45 · T50 · T55
2 x	10	3/8		16 · 21 mm
1 x	10	3/8		28 mm
1 x	12.5	1/2		40 mm
1 x	10	3/8		50 mm
1 x	10	3/8		75 mm
1 x	10	3/8		250 mm
1 x	-	10		198 mm

V4973-L, EAN 4047728**049726**
Soft foam insert · empty

27.49 €
excl. VAT

V4975, EAN 4047728**049757**
Socket tool set



150.- €
excl. VAT

XX	■		Design	Size
18 x	12.5	1/2		10 · 11 · 12 · 13 · 14 · 15 · 16 · 17 · 18 · 19 · 20 · 21 · 22 · 23 · 24 · 27 · 30 · 32 mm
2 x	12.5	1/2		16 · 21 mm

XX	■		Design	Size
1 x	-	12.5		250 mm
1 x	12.5	1/2		75 mm
1 x	12.5	1/2		125 mm
1 x	12.5	1/2		250 mm
1 x	-	12.5		250 mm

V4975-L, EAN 4047728**049740**
Soft foam insert · empty

27.49 €
excl. VAT



V7323, EAN 4047728073240

Socket set



77.62 €
excl. VAT

XX	■	Design	Size
3 x	6.3 1/4		11 · 12 · 13 mm
5 x	10 3/8		E10 · E12 · E14 · E16 · E18
8 x	12.5 1/2		10 · 12 · 14 · 16 · 17 · 18 · 19 · 22 mm

XX	■	Design	Size
5 x	12.5 1/2		E14 · E16 · E18 · E20 · E22
5 x	12.5 1/2		15 · 17 · 19 · 21 · 22 mm

V7323-L, EAN 4047728073233

Soft foam insert · empty

27.49 €
excl. VAT

V5602, EAN 4047728056021

Impact socket set



128.50 €
excl. VAT

XX	■	Design	Size
13 x	12.5 1/2		10 · 11 · 12 · 13 · 14 · 15 · 16 · 17 · 18 · 19 · 21 · 22 · 24 mm

XX	■	Design	Size
13 x	12.5 1/2		10 · 11 · 12 · 13 · 14 · 15 · 16 · 17 · 18 · 19 · 21 · 22 · 24 mm

V5602-L, EAN 4047728056038

Soft foam insert · empty

27.49 €
excl. VAT

V5099, EAN 4047728050999

Screwdriver socket set

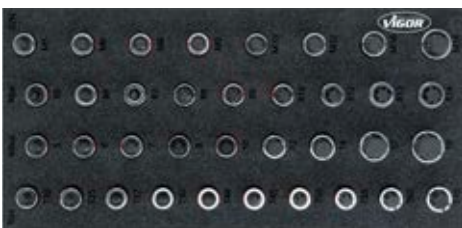

140.- €
excl. VAT

XX	■	Design	Size
10 x	12.5 1/2		T20 · T25 · T27 · T30 · T40 · T45 · T50 · T55 · T60 · T70
9 x	12.5 1/2		M5 · M6 · M7 · M8 · M9 · M10 · M12 · M13 · M14

XX	■	Design	Size
9 x	12.5 1/2		5 · 6 · 7 · 8 · 10 · 12 · 14 · 17 · 19 mm
8 x	12.5 1/2		M5 · M6 · M8 · M9 · M10 · M12 · M14 · M16

V5099-L, EAN 4047728051002

Soft foam insert · empty

27.49 €
excl. VAT

V5095, EAN 4047728050951

TORX® screwdriver socket set



118.50 €
excl. VAT

XX	■	Design	Size
6 x	12.5 1/2		T40 · T45 · T50 · T55 · T60 · T70
10 x	12.5 1/2		T20 · T25 · T27 · T30 · T40 · T45 · T50 · T55 · T60 · T70

XX	■	Design	Size
10 x	12.5 1/2		T20 · T25 · T27 · T30 · T40 · T45 · T50 · T55 · T60 · T70

V5095-L, EAN 4047728050968

Soft foam insert · empty

27.49 €
excl. VAT

Soft foam inserts



V5091, EAN 4047728050913
XZN Serration screwdriver socket set

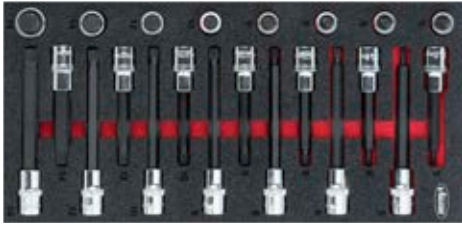

118.50 €
excl. VAT

XX		Design	Size
7 x			M5 · M6 · M8 · M9 · M10 · M12 · M14
7 x			M5 · M6 · M8 · M9 · M10 · M12 · M14

XX		Design	Size
8 x			M5 · M6 · M8 · M9 · M10 · M12 · M14 · M16

V5091-L, EAN 4047728050920
Soft foam insert · empty

27.49 €
excl. VAT

V5097, EAN 4047728050975
Screwdriver socket set for inside hexagon screws



118.50 €
excl. VAT

XX		Design	Size
7 x			5 · 6 · 7 · 8 · 10 · 12 · 14 mm
8 x			5 · 6 · 7 · 8 · 10 · 11 · 12 · 13 mm

XX		Design	Size
9 x			5 · 6 · 7 · 8 · 10 · 12 · 14 · 17 · 19 mm

V5097-L, EAN 4047728050982
Soft foam insert · empty

27.49 €
excl. VAT

V6721, EAN 4047728067461
Double open-end wrench set



80.85 €
excl. VAT

XX		Design	Size
12 x			6x7 · 8x9 · 10x11 · 12x13 · 14x15 · 16x17 · 18x19 · 20x22 · 21x23 · 24x27 · 25x28 · 30x32 mm

V6721-L, EAN 4047728067218
Soft foam insert · empty

27.49 €
excl. VAT

V6723, EAN 4047728067485
Combination wrench set



102.50 €
excl. VAT

XX		Design	Size
18 x			6 · 7 · 8 · 9 · 10 · 11 · 12 · 13 · 14 · 15 · 16 · 17 · 18 · 19 · 21 · 22 · 24 · 27 mm

V6723-L, EAN 4047728067232
Soft foam insert · empty

27.49 €
excl. VAT



V6722, EAN 4047728067478
Double box-end wrench set



XX	Design	Size
11 x		6x7 · 8x9 · 10x11 · 12x13 · 14x15 · 16x17 · 18x19 · 20x22 · 21x23 · 24x27 · 25x28 mm

139.- €
excl. VAT

V6722-L, EAN 4047728067225
Soft foam insert · empty

27.49 €
excl. VAT

V5075, EAN 4047728050753
Ratcheting combination wrench set · short



XX	Design	Size
12 x		8 · 9 · 10 · 11 · 12 · 13 · 14 · 15 · 16 · 17 · 18 · 19 mm

195.- €
excl. VAT

V5075-L, EAN 4047728050760
Soft foam insert · empty

27.49 €
excl. VAT

V4987, EAN 4047728049870
Ratcheting combination wrench set

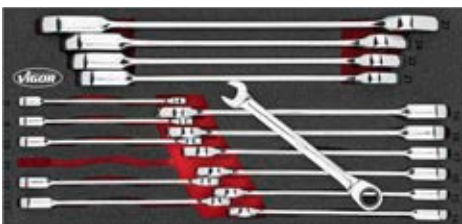

XX	Design	Size
16 x		8 · 9 · 10 · 11 · 12 · 13 · 14 · 15 · 16 · 17 · 18 · 19 · 21 · 22 · 24 · 27 mm

279.- €
excl. VAT

V4987-L, EAN 4047728049863
Soft foam insert · empty

27.49 €
excl. VAT

V5077, EAN 4047728050777
Ratcheting combination wrench set with hinge



XX	Design	Size
12 x		8 · 9 · 10 · 11 · 12 · 13 · 14 · 15 · 16 · 17 · 18 · 19 mm

232.- €
excl. VAT

V5077-L, EAN 4047728050784
Soft foam insert · empty

27.49 €
excl. VAT

Soft foam inserts



V4989, EAN 4047728**049894**
Screwdriver set



61.45 €
excl. VAT

XX	Design	Size
6 x		0.6x3 · 0.8x4 · 1x5.5 · 1.2x6.5 · 1.6x8 · 1.6x10 mm
1 x		PH3
1 x		1x5.5 mm

XX	Design	Size
1 x		PH2
3 x		PH1 · PH2 · PH3

V4989-L, EAN 4047728**049887**
Soft foam insert · empty

27.49 €
excl. VAT

V5068, EAN 4047728**050685**
Screwdriver set with impact cap



89.47 €
excl. VAT

XX	Design	Size
3 x		PH1 · PH2 · PH3

XX	Design	Size
7 x		0.6x3.5-1x4.5-1x5.5- 1.2x6.5 · 1.6x8 · 1.6x10 · 2x12 mm

V5068-L, EAN 4047728**050678**
Soft foam insert · empty

27.49 €
excl. VAT

V4991, EAN 4047728**049917**
TORX® screwdriver set



53.90 €
excl. VAT

XX	Design	Size
11 x		T6 · T7 · T8 · T9 · T10 · T15 · T20 · T25 · T27 · T30 · T40

V4991-L, EAN 4047728**049900**
Soft foam insert · empty

27.49 €
excl. VAT

V5633, EAN 4047728**056335**
Pliers set



99.18 €
excl. VAT

XX	Design	Size
1 x		250 mm
1 x		160 mm

XX	Design	Size
1 x		200 mm
1 x		180 mm

V5633-L, EAN 4047728**056342**
Soft foam insert · empty

27.49 €
excl. VAT



V4995, EAN 4047728049955

Double joint pliers set



193.- €
excl. VAT

XX	Design	Size
1 x		340 mm
1 x		335 mm

XX	Design	Size
1 x		300 mm
1 x		290 mm

V4995-L, EAN 4047728049948

Soft foam insert · empty

27.49 €
excl. VAT

V4999, EAN 4047728049993

Circlip pliers set

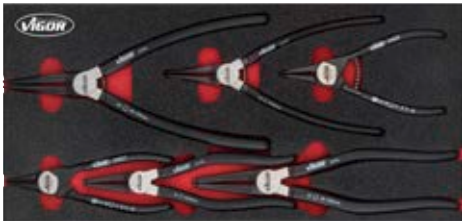

133.50 €
excl. VAT

XX	Design	Size
1 x		180 mm
1 x		180 mm
1 x		180 mm

XX	Design	Size
1 x		180 mm
1 x		140 mm
1 x		140 mm

V4999-L, EAN 4047728049986

Soft foam insert · empty

27.49 €
excl. VAT

V5004, EAN 4047728050043

Grip pliers set



106.50 €
excl. VAT

XX	Design	Size
1 x		16 - 27 mm
1 x		11 - 19 mm
1 x		125 mm

XX	Design	Size
1 x		250 mm
1 x		150 mm

V5004-L, EAN 4047728050005

Soft foam insert · empty

27.49 €
excl. VAT

V6222, EAN 4047728062374

Hammer, chisel and drift pin set



120.50 €
excl. VAT

XX	Design	Size
1 x		∅ 4 mm
1 x		18 mm
1 x		6 mm

XX	Design	Size
1 x		320 mm
7 x		∅ 2 · 3 · 4 · 5 · 6 · 7 · 8 mm

V6222-L, EAN 4047728062633

Soft foam insert · empty

27.49 €
excl. VAT

Soft foam inserts



V5006, EAN 4047728050067
Pliers, hammer and chisel set



95.94 €
excl. VAT

XX	Design	Size
1 x		6 mm
1 x		18 mm
1 x		Ø 4 mm

XX	Design	Size
6 x		Ø 2 · 3 · 4 · 5 · 6 · 8 mm
1 x		Ø 40 mm
1 x		800 g

V5006-L, EAN 4047728050050
Soft foam insert · empty

27.49 €
excl. VAT

V5070, EAN 4047728050708
Hook and scraper set



58.21 €
excl. VAT

XX	Design	Size
1 x		130 mm
1 x		130 mm
1 x		130 mm
1 x		130 mm
1 x		260 mm

XX	Design	Size
1 x		260 mm
1 x		260 mm
1 x		260 mm
1 x		260 mm

V5070-L, EAN 4047728050692
Soft foam insert · empty

27.49 €
excl. VAT

V5017, EAN 4047728050173
Scraper set



86.24 €
excl. VAT

XX	Design	Size
1 x		10 x
1 x		22 mm
1 x		32 mm
1 x		32 mm

XX	Design	Size
1 x		20 mm
1 x		20 mm
1 x		40 mm

V5017-L, EAN 4047728050166
Soft foam insert · empty

27.49 €
excl. VAT

V5072, EAN 4047728050722
File set



65.76 €
excl. VAT

XX	Design	Size
1 x		310 mm
1 x		310 mm
1 x		310 mm

XX	Design	Size
1 x		310 mm
1 x		310 mm

V5072-L, EAN 4047728050715
Soft foam insert · empty

27.49 €
excl. VAT



V5011, EAN 4047728050111

VDE socket set



333.- €
excl. VAT

XX	■	Design	Size	XX	■	Design	Size
9 x	125 1/2		8 · 10 · 12 · 13 · 14 · 17 · 19 · 22 · 24 mm	1 x	125 1/2		125 mm
3 x	125 1/2		5 · 6 · 8 mm	1 x	-		255 mm

V5011-L, EAN 4047728050104

Soft foam insert · empty

27.49 €
excl. VAT

V5013, EAN 4047728050135

VDE screwdriver set



56.06 €
excl. VAT

XX	■	Design	Size	XX	■	Design	Size
3 x	+		PH0 · PH1 · PH2	1 x	-		0.5 x 3 mm
4 x	-		0.5 x 3 · 0.8 x 4 · 1 x 5.5 · 1.2 x 6.5 mm				

V5013-L, EAN 4047728050128

Soft foam insert · empty

27.49 €
excl. VAT

V5015, EAN 4047728050159

VDE pliers set



150.- €
excl. VAT

XX	■	Design	Size	XX	■	Design	Size
1 x			180 mm	1 x			200 mm
1 x			160 mm	1 x			160 mm
1 x			160 mm				

V5015-L, EAN 4047728050142

Soft foam insert · empty

27.49 €
excl. VAT

V7520, EAN 4047728075824

12-point socket set

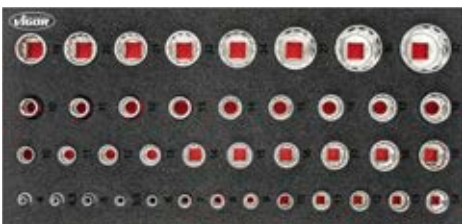

139.- €
excl. VAT

XX	■	Design	Size	XX	■	Design	Size
17 x	125 1/2		10 · 11 · 12 · 13 · 14 · 15 · 16 · 17 · 18 · 19 · 20 · 21 · 22 · 24 · 27 · 30 · 32 mm	10 x	10 3/8		10 · 11 · 12 · 13 · 14 · 15 · 16 · 17 · 18 · 19 mm
				13 x	6.3 1/4		4 · 4.5 · 5 · 5.5 · 6 · 7 · 8 · 9 · 10 · 11 · 12 · 13 · 14 mm

NEW

V7520-L, EAN 4047728075800

Soft foam insert · empty

27.50 €
excl. VAT

Soft foam inserts



V5103, EAN 4047728051033
Socket set



167.-€
excl. VAT

XX			Design	Size	
13 x	6.3	1/4		4 · 4.5 · 5 · 5.5 · 6 · 7 · 8 · 9 · 10 · 11 · 12 · 13 · 14 mm	
6 x	6.3	1/4		3 · 4 · 5 · 6 · 7 · 8 mm	
3 x	6.3	1/4		PH1 · PH2 · PH3	
3 x	6.3	1/4		PZ1 · PZ2 · PZ3	
3 x	6.3	1/4		0.8x4-1x5.5-1.2x7 mm	
6 x	6.3	1/4		T10 · T15 · T20 · T25 · T30 · T40	
1 x	-	6.3	1/4	150 mm	
1 x	6.3	1/4	6.3	1/4	110 mm
1 x	6.3	1/4	6.3	1/4	40 mm
1 x	6.3	1/4	6.3	1/4	145 mm
1 x	6.3	1/4	6.3	1/4	50 mm

XX			Design	Size	
1 x	6.3	1/4	6.3	1/4	100 mm
18 x	12.5	1/2		10 · 11 · 12 · 13 · 14 · 15 · 16 · 17 · 18 · 19 · 20 · 21 · 22 · 23 · 24 · 27 · 30 · 32 mm	
2 x	12.5	1/2		16 · 21 mm	
1 x	-	12.5	1/2	250 mm	
1 x	12.5	1/2	12.5	1/2	75 mm
1 x	12.5	1/2	12.5	1/2	125 mm
1 x	12.5	1/2	12.5	1/2	250 mm
4 x	-	6.3	1/4	1.3 · 1.5 · 2 · 2.5 mm	
1 x	-	6.3	1/4	150 mm	
1 x	-	12.5	1/2	250 mm	
1 x	6.3	1/4	6.3	1/4	25 mm

V5103-L, EAN 4047728051040
Soft foam insert · empty

38.27 €
excl. VAT

V5081, EAN 4047728050814
Screwdriver set



113.-€
excl. VAT

XX			Design	Size
9 x				T10 · T15 · T20 · T25 · T27 · T30 · T40 · T45 · T50
1 x				0.5x3 mm
9 x				1.5 · 2 · 2.5 · 3 · 4 · 5 · 6 · 8 · 10 mm
6 x				0.6x3 · 0.8x4 · 1x5.5 · 1.2x6.5 · 1.6x8 · 1.6x10 mm

XX			Design	Size
4 x				PH0 · PH1 · PH2 · PH3
1 x				1x5.5 mm
1 x				PH2

V5081-L, EAN 4047728050821
Soft foam insert · empty

38.27 €
excl. VAT



V5085, EAN 4047728**050852**

Hammer and chisel set



156.50 €
excl. VAT

XX	Design	Size
1 x		20 mm
1 x		32 mm
1 x		18 mm
1 x		Ø 4 mm
1 x		6 mm

XX	Design	Size
6 x		Ø 2 · 3 · 4 · 5 · 6 · 8 mm
1 x		280 mm · 1500 g
1 x		350 g · 800 g
1 x		Ø 32 mm · 280 mm

V5085-L, EAN 4047728**050869**

Soft foam insert · empty

38.27 €
excl. VAT

V5087, EAN 4047728**050876**

VDE tool set



210.- €
excl. VAT

XX	Design	Size
1 x		0.5x3 mm
1 x		160 mm
1 x		160 mm
1 x		180 mm

XX	Design	Size
1 x		200 mm
1 x		160 mm
4 x		0.5x3 · 0.8x4 · 1x5.5 · 1.2x6.5mm
3 x		PH0 · PH1 · PH2

V5087-L, EAN 4047728**050883**

Soft foam insert · empty

38.27 €
excl. VAT

Soft foam inserts



V4188, EAN 4047728041881

Socket tool set



264.- €
excl. VAT

XX	XX	XX	Design	Size	XX	XX	XX	Design	Size
5 x	6.3 1/4	+		R5 · R6 · R7 · R8 · R9	6 x	10 3/8	+		E10 · E11 · E12 · E14 · E16 · E18
3 x	6.3 1/4	+		T5 · T6 · T7	6 x	10 3/8	●		10 · 11 · 12 · 13 · 14 · 15 mm
3 x	6.3 1/4	○		M5 · M6 · M8	10 x	10 3/8	●		10 · 11 · 12 · 13 · 14 · 15 · 16 · 17 · 18 · 19 mm
9 x	6.3 1/4	+		T7H · T10H · T15H · T20H · T25H · T27H · T30H · T40H · T45H	17 x	12 1/2	●		10 · 11 · 12 · 13 · 14 · 15 · 16 · 17 · 18 · 19 · 20 · 21 · 22 · 24 · 27 · 30 · 32 mm
6 x	8 9/16	+		T40 · T45 · T50 · T55 · T60 · T70	5 x	12 1/2	●		16 · 17 · 18 · 19 · 22 mm
5 x	8 9/16	○		7 · 8 · 10 · 12 · 14 mm	2 x	12 1/2	+		E20 · E24
2 x	8 9/16	+		PH3 · PH4	13 x	6.3 1/4	●		4 · 4.5 · 5 · 5.5 · 6 · 7 · 8 · 9 · 10 · 11 · 12 · 13 · 14 mm
2 x	8 9/16	+		PZ3 · PZ4	7 x	6.3 1/4	●		4 · 5 · 6 · 7 · 8 · 9 · 10 mm
3 x	8 9/16	○		1.6x81.6x10-2x12 mm	5 x	6.3 1/4	+		E4 · E5 · E6 · E7 · E8
6 x	8 9/16	+		T40H · T45H · T50H · T55H · T60H · T70H	1 x	-	6.3 1/4		150 mm
4 x	-	○		1.3 · 1.5 · 2 · 2.5 mm	1 x	-	10 3/8		198 mm
1 x	10 3/8	8 9/16		28 mm	1 x	-	12 1/2		250 mm
1 x	12 1/2	8 9/16		37 mm	1 x	6.3 1/4	6.3 1/4		40 mm
1 x	-	6.3 1/4		150 mm	1 x	10 3/8	10 3/8		50 mm
1 x	6.3 1/4	6.3 1/4		110 mm	1 x	12 1/2	12 1/2		75 mm
1 x	-	12 1/2		43.7 mm	1 x	6.3 1/4	6.3 1/4		50 mm
4 x	6.3 1/4	○		3 · 4 · 5 · 6 mm	1 x	6.3 1/4	6.3 1/4		100 mm
4 x	6.3 1/4	○		0.8 x 4 · 1x5.5 · 1.2x6.5 · 1.2x7 mm	1 x	10 3/8	10 3/8		125 mm
3 x	6.3 1/4	+		PH0 · PH1 · PH2	1 x	12 1/2	12 1/2		125 mm
3 x	6.3 1/4	+		PZ0 · PZ1 · PZ2	1 x	12 1/2	12 1/2		250 mm
7 x	6.3 1/4	+		T9 · T10 · T15 · T20 · T25 · T27 · T30	1 x	10 3/8	●		18 mm
7 x	6.3 1/4	+		T9H · T10H · T15H · T20H · T25H · T27H · T30H	2 x	12 1/2	●		16 · 21 mm

V4130, EAN 4047728041300

Soft foam insert · empty

50.13 €
excl. VAT

V4587, EAN 4047728045872
Socket set for VW and AUDI



355.50 €
excl. VAT

XX	■		Design	Size
4 x	6.3 1/4	⊕		T6 · T7 · T8 · T9
1 x	6.3 1/4	⊕		25 mm
1 x	6.3 1/4	10 3/8		26 mm
1 x	10 3/8	6.3 1/4		27 mm
1 x	10 3/8	12.5 1/2		36 mm
1 x	12.5 1/2	10 3/8		36 mm
1 x	12.5 1/2	20 3/4		46 mm
1 x	20 3/4	12.5 1/2		50 mm
1 x	-	6.3 1/4		150 mm
1 x	-	12.5 1/2		250 mm
8 x	12.5 1/2	⊕		T25 · T27 · T30 · T40 · T45 · T50 · T55 · T60
5 x	6.3 1/4	⊕		T10 · T15 · T20 · T25 · T27
4 x	6.3 1/4	○		3 · 4 · 5 · 6 mm
2 x	6.3 1/4	⊕		PH1 · PH2
1 x	6.3 1/4	⊖		1 x 5.5 mm
2 x	12.5 1/2	●		32 · 36 mm
17 x	12.5 1/2	●		10 · 11 · 12 · 13 · 14 · 15 · 16 · 17 · 18 · 19 · 20 · 21 · 22 · 24 · 27 · 30 · 32 mm

XX	■		Design	Size
6 x	12.5 1/2	⊕		E10 · E12 · E14 · E16 · E18 · E20
15 x	12.5 1/2	●		10 · 12 · 13 · 14 · 15 · 16 · 17 · 18 · 19 · 21 · 22 · 24 · 27 · 30 · 32 mm
12 x	6.3 1/4	●		4 · 5 · 5.5 · 6 · 7 · 8 · 9 · 10 · 11 · 12 · 13 · 14 mm
4 x	6.3 1/4	⊕		E4 · E5 · E6 · E8
2 x	6.3 1/4	●		8 · 9 mm
1 x	-	6.3 1/4		150 mm
1 x	-	12.5 1/2		250 mm
1 x	6.3 1/4	6.3 1/4		40 mm
1 x	12.5 1/2	12.5 1/2		75 mm
1 x	6.3 1/4	6.3 1/4		50 mm
1 x	6.3 1/4	6.3 1/4		100 mm
1 x	12.5 1/2	12.5 1/2		50 mm
1 x	12.5 1/2	12.5 1/2		75 mm
1 x	12.5 1/2	12.5 1/2		250 mm
2 x	12.5 1/2	●		17 · 19 mm

V4514, EAN 4047728045148
Soft foam insert · empty

50.13 €
excl. VAT

V5115, EAN 4047728051293
Socket set



210.- €
excl. VAT

XX	■		Design	Size
12 x	6.3 1/4	●		4 · 5 · 5.5 · 6 · 7 · 8 · 9 · 10 · 11 · 12 · 13 · 14 mm
1 x	6.3 1/4	6.3 1/4		40 mm
1 x	6.3 1/4	6.3 1/4		50 mm
1 x	6.3 1/4	6.3 1/4		100 mm
1 x	-	6.3 1/4		150 mm
1 x	-	6.3 1/4		150 mm
17 x	12.5 1/2	●		10 · 11 · 12 · 13 · 14 · 15 · 17 · 16 · 18 · 19 · 20 · 21 · 22 · 24 · 27 · 30 · 32 mm
2 x	12.5 1/2	●		16 · 21 mm
1 x	12.5 1/2	12.5 1/2		75 mm
1 x	12.5 1/2	12.5 1/2		125 mm

XX	■		Design	Size
1 x	12.5 1/2	12.5 1/2		250 mm
1 x	-	12.5 1/2		250 mm
1 x	-	12.5 1/2		43.7 mm
1 x	6.3 1/4	6.3 1/4		25 mm
1 x	6.3 1/4	10 3/8		26 mm
1 x	10 3/8	6.3 1/4		27 mm
1 x	10 3/8	12.5 1/2		36 mm
1 x	12.5 1/2	10 3/8		36 mm
1 x	12.5 1/2	20 3/4		46 mm
1 x	20 3/4	12.5 1/2		50 mm
5 x	6.3 1/4	⊕ ⊖ ⊕ ⊖		32 x

V5115-L, EAN 4047728051811
Soft foam insert · empty

50.13 €
excl. VAT

Soft foam inserts



V2837, EAN 4047728028370

Socket set

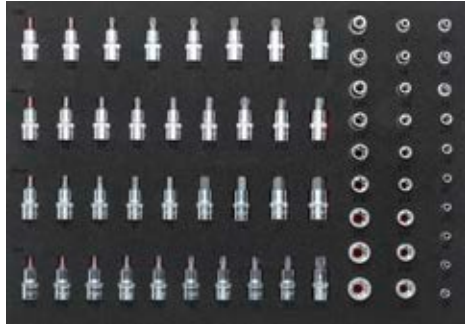

221.-€
excl. VAT

XX	■	Design	Size
7 x	6.3 1/4		E4 · E5 · E6 · E7 · E8 · E10 · E11
12 x	10 3/8		E4 · E5 · E6 · E7 · E8 · E10 · E11 · E12 · E14 · E16 · E18 · E20
9 x	12 1/2		E10 · E11 · E12 · E14 · E20 · E22 · E24
8 x	12 1/2		M5 · M6 · M8 · M9 · M10 · M12 · M14 · M16

XX	■	Design	Size
9 x	12 1/2		5 · 6 · 7 · 8 · 10 · 12 · 14 · 17 · 19 mm
9 x	12 1/2		M5 · M6 · M7 · M8 · M9 · M10 · M12 · M13 · M14
10 x	12 1/2		T20 · T25 · T27 · T30 · T40 · T45 · T50 · T55 · T60 · T70

V2838, EAN 4047728028387

Soft foam insert · empty

50.13 €
excl. VAT

V5109, EAN 4047728051095

Socket set



332.-€
excl. VAT

XX	■	Design	Size
16 x	20 3/4		19 · 21 · 22 · 23 · 24 · 26 · 27 · 28 · 30 · 32 · 34 · 36 · 38 · 41 · 46 · 50 mm
1 x	-		500 mm

XX	■	Design	Size
1 x	20 3/4		200 mm
1 x	20 3/4		100 mm
1 x	20 3/4		400 mm
1 x	-		450 mm

V5109-L, EAN 4047728051101

Soft foam insert · empty

50.13 €
excl. VAT

V4753, EAN 4047728047531

Screwdriver socket set

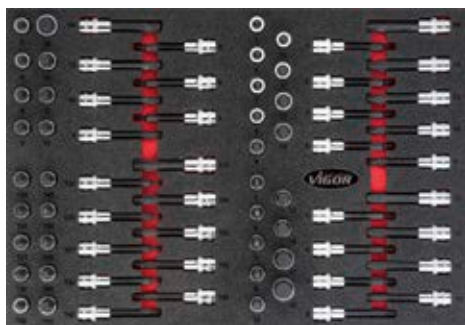

279.-€
excl. VAT

XX	■	Design	Size
9 x	12 1/2		M5 · M6 · M7 · M8 · M9 · M10 · M12 · M13 · M14
9 x	12 1/2		M5 · M6 · M7 · M8 · M9 · M10 · M12 · M13 · M14
10 x	12 1/2		T20 · T25 · T27 · T30 · T40 · T45 · T50 · T55 · T60 · T70
10 x	12 1/2		T20 · T25 · T27 · T30 · T40 · T45 · T50 · T55 · T60 · T70

XX	■	Design	Size
7 x	12 1/2		M5 · M6 · M8 · M9 · M10 · M12 · M14
8 x	12 1/2		M5 · M6 · M8 · M9 · M10 · M14 · M16 · M12
8 x	12 1/2		5 · 6 · 7 · 8 · 10 · 11 · 12 · 13 mm
9 x	12 1/2		5 · 6 · 7 · 8 · 10 · 12 · 14 · 17 · 19 mm

V4752, EAN 4047728047524

Soft foam insert · empty

50.13 €
excl. VAT



V4727, EAN 4047728**047272**

Screwdriver socket set

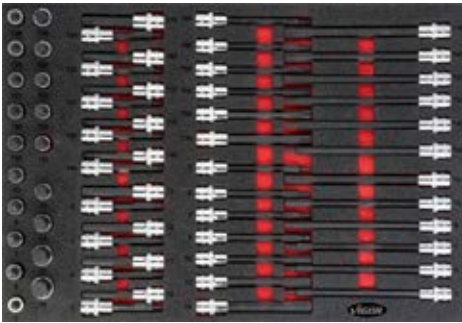

257.50 €
excl. VAT

XX	■	Design	Size	XX	■	Design	Size
10 x	122½	1/2	T20 · T25 · T27 · T30 · T40 · T45 · T50 · T55 · T60 · T70	9 x	122½	1/2	5 · 6 · 7 · 8 · 10 · 12 · 14 · 17 · 19 mm
10 x	122½	1/2	T20 · T25 · T27 · T30 · T40 · T45 · T50 · T55 · T60 · T70	8 x	122½	1/2	5 · 6 · 7 · 8 · 10 · 11 · 12 · 13 mm
6 x	122½	1/2	T40 · T45 · T50 · T55 · T60 · T70	7 x	122½	1/2	5 · 6 · 7 · 8 · 10 · 12 · 14 mm
6 x	122½	1/2	T40 · T45 · T50 · T55 · T60 · T70	6 x	122½	1/2	5 · 6 · 7 · 8 · 10 · 12 mm

V4726, EAN 4047728**047265**

Soft foam insert · empty

50.13 €
excl. VAT

V4729, EAN 4047728**047296**

Screwdriver socket set

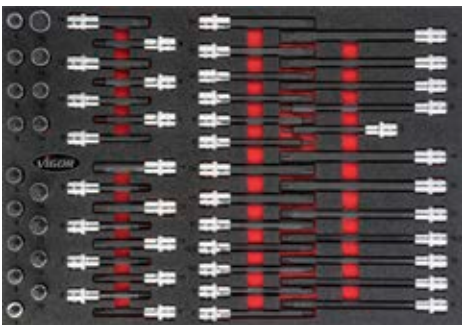

262.- €
excl. VAT

XX	■	Design	Size	XX	■	Design	Size
8 x	122½	1/2	M5 · M6 · M8 · M9 · M10 · M12 · M14 · M16	9 x	122½	1/2	M5 · M6 · M7 · M8 · M9 · M10 · M12 · M13 · M14
7 x	122½	1/2	M5 · M6 · M8 · M9 · M10 · M12 · M14	9 x	122½	1/2	M5 · M6 · M7 · M8 · M9 · M10 · M12 · M13 · M14
7 x	122½	1/2	M5 · M6 · M8 · M9 · M10 · M12 · M14	7 x	122½	1/2	M8 · M9 · M10 · M10.3 · M12 · M13 · M14
4 x	122½	1/2	M8 · M10 · M12 · M14	7 x	122½	1/2	M8 · M9 · M10 · M10.3 · M12 · M13 · M14

V4728, EAN 4047728**047289**

Soft foam insert · empty

50.13 €
excl. VAT

V6649, EAN 4047728**067447**

Combination wrench, double box-end wrench set



182.- €
excl. VAT

XX	■	Design	Size	XX	■	Design	Size
17 x	●	●	6 · 7 · 8 · 9 · 10 · 11 · 12 · 13 · 14 · 15 · 16 · 17 · 18 · 19 · 21 · 22 · 24 mm	8 x	●	●	6x7 · 8x9 · 10x11 · 12x13 · 14x15 · 16x17 · 18x19 · 21x23 mm

V6649-L, EAN 4047728**066495**

Soft foam insert · empty

50.13 €
excl. VAT

Soft foam inserts



V6726, EAN 4047728067515
Double open-end, double box-end
and combination wrench set

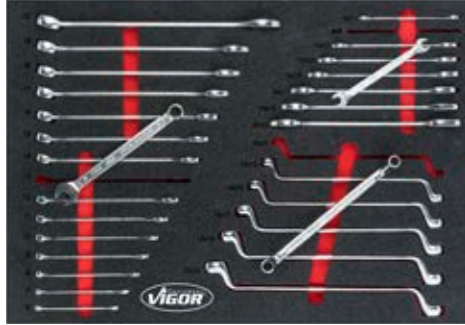

XX	Design	Size
8 x		6x7 · 8x9 · 10x11 · 12x13 · 14x15 · 16x17 · 18x19 · 20x22 mm
15 x		6 · 7 · 8 · 9 · 10 · 11 · 12 · 13 · 14 · 15 · 16 · 17 · 18 · 19 · 22 mm

XX	Design	Size
6 x		10x11 · 12x13 · 14x15 · 16x17 · 18x19 · 20x22 mm

210.- €
excl. VAT

V6726-L, EAN 4047728067263
Soft foam insert · empty

50.13 €
excl. VAT

V6643, EAN 4047728067430
Double box-end wrench,
double open-end wrench,
combination wrench set



XX	Design	Size
9 x		6x7 · 8x9 · 10x11 · 12x13 · 14x15 · 16x17 · 18x19 · 20x22 · 21x23 mm
17 x		6 · 7 · 8 · 9 · 10 · 11 · 12 · 13 · 14 · 15 · 16 · 17 · 18 · 19 · 22 · 24 · 27 mm

XX	Design	Size
10 x		6x7 · 8x9 · 10x11 · 12x13 · 14x15 · 16x17 · 18x19 · 20x22 · 21x23 · 24x27 mm

268.50 €
excl. VAT

V6643-L, EAN 4047728066433
Soft foam insert · empty

50.13 €
excl. VAT

V6724, EAN 4047728067492
Double open-end wrench,
combination wrench,
ratcheting combination wrench set



XX	Design	Size
12 x		8 · 9 · 10 · 11 · 12 · 13 · 14 · 15 · 16 · 17 · 18 · 19 mm
12 x		6x7 · 8x9 · 10x11 · 12x13 · 14x15 · 16x17 · 18x19 · 20x22 · 21x23 · 24x27 · 25x28 · 30x32 mm

XX	Design	Size
21 x		6 · 7 · 8 · 9 · 10 · 11 · 12 · 13 · 14 · 15 · 16 · 17 · 18 · 19 · 20 · 21 · 22 · 24 · 27 · 30 · 32 mm

NEW

346.50 €
excl. VAT

V6724-L, EAN 4047728067249
Soft foam insert · empty

50.13 €
excl. VAT



V6820, EAN 4047728071147

Combination wrench, extension, pry bar set for VW and AUDI

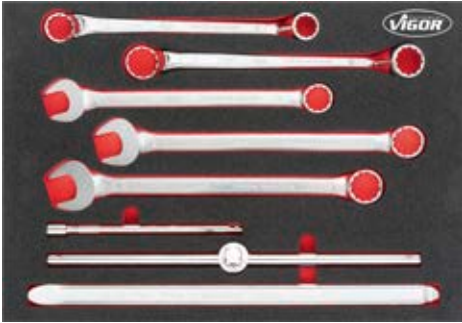

167.-€
excl. VAT

XX	■	●	Design	Size
3 x	-	●●		27 · 30 · 32 mm
2 x	-	●		24x27 · 30x32 mm

XX	■	●	Design	Size
1 x	$\frac{1}{2}$	$\frac{1}{2}$		250 mm
1 x	-	$\frac{3}{4}$		450 mm

V6820-L, EAN 4047728071130

Soft foam insert · empty

50.13€
excl. VAT

V5173, EAN 4047728051736

Socket, offset screwdriver, ratcheting combination wrench set



243.50€
excl. VAT

XX	■	●	Design	Size
9 x	-	○		1.5 · 2 · 2.5 · 3 · 4 · 5 · 6 · 8 · 10
9 x	-	○		T10 · T15 · T20 · T25 · T27 · T30 · T40 · T45 · T50
2 x	$\frac{1}{2}$	○		M8 · M14
2 x	$\frac{1}{2}$	○		M10 · M12

XX	■	●	Design	Size
7 x	$\frac{1}{2}$	○		M5 · M6 · M8 · M10 · M14 · M16 · M12
4 x	$\frac{1}{2}$	○		6 · 7 · 8 · 10 mm
9 x	$\frac{1}{2}$	○		5 · 6 · 7 · 8 · 10 · 12 · 14 · 17 · 19 mm
6 x	-	●●		8 · 10 · 12 · 13 · 17 · 19 mm

V5173-L, EAN 4047728051743

Soft foam insert · empty

50.13€
excl. VAT

V4588, EAN 4047728045889

Screwdriver set for VW and AUDI



161.50€
excl. VAT

XX	●	Design	Size
10 x	●		T6 · T7 · T8 · T9 · T10 · T15 · T20 · T25 · T27 · T30
2 x	●		PH1 · PH2
3 x	●		1x5.5 · 1.2x6.5 · 1x4.5 mm
3 x	●		PH3 · PH1 · PH2

XX	●	Design	Size
6 x	●		0.6x3 · 0.8x4 · 1x5.5 · 1.2x6.5 · 1.6x8 · 1.6x10 mm
1 x	●		1x5.5 mm
1 x	●		PH2

V4501, EAN 4047728045018

Soft foam insert · empty

50.13€
excl. VAT

Soft foam inserts



V4230, EAN 4047728042307
Screwdriver set



XX	Design	Size
6 x		6 · 7 · 8 · 10 · 12 · 13 mm
6 x		0.6x3 · 0.8x4 · 1x5.5 · 1.2x6.5 · 1.6x8 · 1.6x10 mm
4 x		PH0 · PH1 · PH2 · PH3
1 x		1x5.5 mm
1 x		PH2

XX	Design	Size
7 x		T10 · T15 · T20 · T25 · T27 · T30 · T40
1 x		0.5x3 mm
2 x		PH1 · PH2
4 x		0.6x3.5 · 1x4.5 · 1x5.5 · 1.2x6.5 mm



183.50 €
excl. VAT

V4231, EAN 4047728042314
Soft foam insert · empty

50.13 €
excl. VAT

V5175, EAN 4047728051750
T-handle screwdriver and offset screwdriver set



XX	Design	Size
9 x		1.5 · 2 · 2.5 · 3 · 4 · 5 · 6 · 8 · 10
9 x		T10 · T15 · T20 · T25 · T27 · T30 · T40 · T45 · T50

XX	Design	Size
8 x		2 · 2.5 · 3 · 4 · 5 · 6 · 8 · 10 mm
8 x		T9 · T10 · T15 · T20 · T25 · T27 · T30 · T40



143.50 €
excl. VAT

V5175-L, EAN 4047728051767
Soft foam insert · empty

50.13 €
excl. VAT

V5634, EAN 4047728056366
Hammer, pliers and screwdriver set



XX	Design	Size
4 x		0.6x3 · 0.8x4 · 1x5.5 · 1.2x6.5 mm
3 x		PH0 · PH1 · PH2
1 x		250 mm
1 x		300 g
1 x		Ø 32 mm
1 x		160 mm

XX	Design	Size
1 x		200 mm
6 x		Ø 2 · 3 · 4 · 5 · 6 · 8 mm
1 x		Ø 4 mm
1 x		0.05 – 1.00 mm
1 x		-



183.50 €
excl. VAT

V5634-L, EAN 4047728056359
Soft foam insert · empty

50.13 €
excl. VAT



V5636, EAN 4047728055970

Pliers and hammer set



332.-€
excl. VAT

XX	Design	Size
1 x		250 mm
1 x		140 mm
1 x		140 mm
1 x		180 mm
1 x		180 mm
1 x		180 mm
1 x		180 mm
1 x		180 mm
1 x		800 g

XX	Design	Size
1 x		∅ 40 mm
1 x		200 mm
1 x		180 mm
1 x		160 mm
1 x		340 mm
1 x		22 mm
1 x		10 x
1 x		40 mm

V5636-L, EAN 4047728055963

Soft foam insert · empty

50.13€
excl. VAT

V5111, EAN 4047728051118

Screwdriver and pliers set



188.50€
excl. VAT

XX	Design	Size
1 x		300 g
5 x		∅ 2 · 3 · 4 · 6 · 8 mm
1 x		∅ 4 mm
1 x		250 mm
1 x		160 mm
1 x		200 mm

XX	Design	Size
4 x		0.6 x 3 · 0.8 x 4 · 1 x 5.5 · 1.2 x 6.5 mm
3 x		PH0 · PH1 · PH2
1 x		0.05 – 1.00 mm
9 x		T10 · T15 · T20 · T25 · T27 · T30 · T40 · T45 · T50
9 x		1.5 · 2 · 2.5 · 3 · 4 · 5 · 6 · 8 · 10

V5111-L, EAN 4047728051125

Soft foam insert · empty

50.13€
excl. VAT

V5635, EAN 4047728055956

Pliers set for VW and AUDI



218.-€
excl. VAT

XX	Design	Size
1 x		250 mm
1 x		160 mm
1 x		200 mm
1 x		180 mm
1 x		180 mm

XX	Design	Size
1 x		180 mm
1 x		180 mm
1 x		250 mm
1 x		180 mm

V5635-L, EAN 4047728055925

Soft foam insert · empty

50.13€
excl. VAT

Soft foam inserts



V5637, EAN 4047728055994
Pliers, hammer and chisel set



277.-€
excl. VAT

XX	Design	Size
1 x		300 g
1 x		Ø 32 mm
1 x		250 mm
1 x		160 mm
1 x		180 mm
1 x		180 mm
1 x		180 mm
1 x		180 mm

XX	Design	Size
6 x		Ø 2 · 3 · 4 · 5 · 6 · 8 mm
1 x		18 mm
1 x		6 mm
1 x		Ø 4 mm
1 x		0.05 – 1.00 mm
1 x		22 mm
1 x		180 mm
1 x		-

V5637-L, EAN 4047728055987
Soft foam insert · empty

50.13€
excl. VAT

V4511, EAN 4047728045117
Hammer, chisel, drift pin set for VW and AUDI



218.-€
excl. VAT

XX	Design	Size
1 x		0.05 – 1.00 mm
1 x		-
1 x		22 mm
1 x		Ø 4 mm
1 x		18 mm
5 x		Ø 3 · 4 · 5 · 6 · 8 mm
1 x		Ø 32 mm

XX	Design	Size
1 x		500 g
1 x		170 mm
1 x		110 mm
1 x		10x11 mm
1 x		-
1 x		-
1 x		700 mm

V4510, EAN 4047728045100
Soft foam insert · empty

50.13€
excl. VAT



V6821, EAN 4047728068222

Socket set

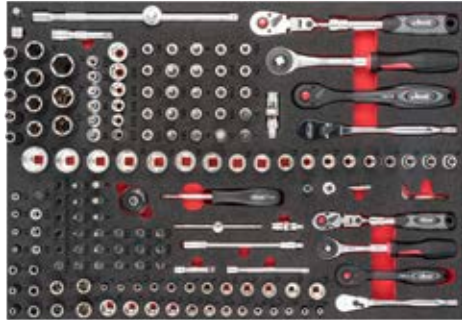

505.50 €
excl. VAT

XX	■		Design	Size	XX	■		Design	Size	
12 x	10	3/8		E4 · E5 · E6 · E7 · E8 · E10 · E11 · E12 · E14 · E16 · E18 · E20	13 x	6.3	1/4		4 · 4.5 · 5 · 5.5 · 6 · 7 · 8 · 9 · 10 · 11 · 12 · 13 · 14 mm	
18 x	10	3/8		6 · 7 · 8 · 9 · 10 · 11 · 12 · 13 · 14 · 15 · 16 · 17 · 18 · 19 · 20 · 21 · 22 · 24 mm	6 x	6.3	1/4		T10 · T15 · T20 · T25 · T30 · T40	
10 x	10	3/8		8 · 9 · 10 · 11 · 12 · 13 · 14 · 15 · 17 · 19 mm	7 x	6.3	1/4		T19H · T10H · T15H · T20H · T25H · T27H · T30H	
2 x	10	3/8		16 · 21 mm	6 x	6.3	1/4		3 · 4 · 5 · 6 · 7 · 8 mm	
9 x	10	3/8		T15 · T20 · T25 · T27 · T30 · T40 · T45 · T50 · T55	3 x	6.3	1/4		PH1 · PH2 · PH3	
7 x	10	3/8		3 · 4 · 5 · 6 · 7 · 8 · 10 mm	3 x	6.3	1/4		PZ1 · PZ2 · PZ3	
3 x	10	3/8		PH1 · PH2 · PH3	3 x	6.3	1/4		0.8x4 · 1x5.5 · 1.2x6.5 mm	
3 x	10	3/8		PZ1 · PZ2 · PZ3	1 x	6.3	1/4		26 mm	
3 x	10	3/8		0.8x5.5-1x7 · 1.2x8 mm	1 x	-	10	3/8		198 mm
1 x	10	3/8		250 mm	1 x	-	10	3/8		198 mm
1 x	10	3/8		50 mm	1 x	-	10	3/8		237 mm
1 x	10	3/8		75 mm	1 x	-	6.3	1/4		150 mm
1 x	10	3/8		36 mm	1 x	6.3	1/4		110 mm	
1 x	10	3/8		27 mm	1 x	6.3	1/4		40 mm	
1 x	12.5	1/2		40 mm	1 x	6.3	1/4		145 mm	
7 x	6.3	1/4		E4 · E5 · E6 · E7 · E8 · E10 · E11	1 x	6.3	1/4		50 mm	
11 x	6.3	1/4		4 · 5 · 6 · 7 · 8 · 9 · 10 · 11 · 12 · 13 · 14 mm	1 x	6.3	1/4		100 mm	
10 x	6.3	1/4		4 · 5 · 6 · 7 · 8 · 9 · 10 · 11 · 12 · 13 mm	1 x	-	6.3	1/4		150 mm
					1 x	-	6.3	1/4		150 mm
					1 x	-	6.3	1/4		176 mm
					1 x	-	6.3	1/4		225 mm
					1 x	-	6.3	1/4		29 mm
					1 x	8	3/8		30 mm	
					1 x	6.3	1/4		25 mm	

V6821-L, EAN 4047728068055

Soft foam insert · empty

50.13 €
excl. VAT

V6822, EAN 4047728068284

Socket set

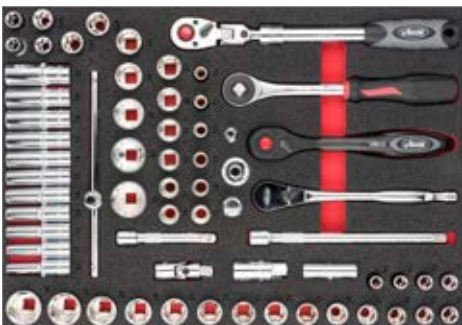

430.- €
excl. VAT

XX	■		Design	Size	XX	■		Design	Size	
6 x	12.5	1/2		E14 · E16 · E18 · E20 · E22 · E24	1 x	12.5	1/2		36 mm	
18 x	12.5	1/2		10 · 11 · 12 · 13 · 14 · 15 · 16 · 17 · 18 · 19 · 20 · 21 · 22 · 23 · 24 · 27 · 30 · 32 mm	1 x	12.5	1/2		75 mm	
11 x	12.5	1/2		10 · 11 · 12 · 13 · 14 · 15 · 16 · 17 · 18 · 19 · 22 mm	1 x	12.5	1/2		125 mm	
2 x	12.5	1/2		16 · 21 mm	1 x	12.5	1/2		250 mm	
17 x	12.5	1/2		10 · 11 · 12 · 13 · 14 · 15 · 16 · 17 · 18 · 19 · 20 · 21 · 22 · 24 · 27 · 30 · 32 mm	1 x	12.5	1/2		46 mm	
					1 x	20	3/4		50 mm	
					1 x	-	12.5	1/2		288 mm
					1 x	-	12.5	1/2		250 mm
					1 x	-	12.5	1/2		250 mm
					1 x	-	12.5	1/2		250 mm
					1 x	-	12.5	1/2		-

V6822-L, EAN 4047728068062

Soft foam insert · empty

50.13 €
excl. VAT

Soft foam inserts



V6809, EAN 4047728068307
Screwdriver socket set

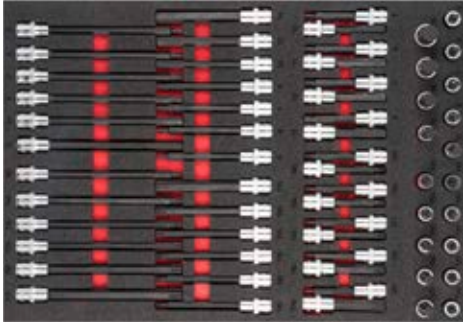

257.50 €
excl. VAT

XX	■	Design	Size
10 x	$\frac{12.9}{16}$ 1/2		T20 · T25 · T27 · T30 · T40 · T45 · T50 · T55 · T60 · T70
10 x	$\frac{12.9}{16}$ 1/2		T20 · T25 · T27 · T30 · T40 · T45 · T50 · T55 · T60 · T70
6 x	$\frac{12.9}{16}$ 1/2		T40 · T45 · T50 · T55 · T60 · T70

XX	■	Design	Size
6 x	$\frac{12.9}{16}$ 1/2		T40 · T45 · T50 · T55 · T60 · T70
9 x	$\frac{12.9}{16}$ 1/2		5 · 6 · 7 · 8 · 10 · 12 · 14 · 17 · 19 mm
8 x	$\frac{12.9}{16}$ 1/2		5 · 6 · 7 · 8 · 10 · 11 · 12 · 13 mm
7 x	$\frac{12.9}{16}$ 1/2		5 · 6 · 7 · 8 · 10 · 12 · 14 mm
6 x	$\frac{12.9}{16}$ 1/2		5 · 6 · 7 · 8 · 10 · 12 mm

V6809-L, EAN 4047728068093
Soft foam insert · empty

50.13 €
excl. VAT

V6810, EAN 4047728068413
Screwdriver socket set

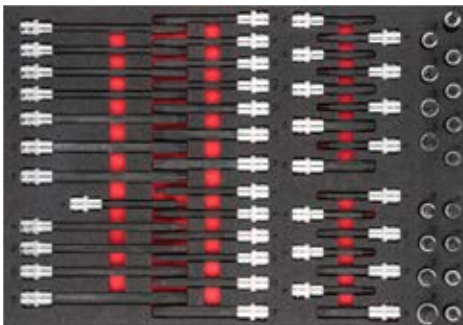

262.- €
excl. VAT

XX	■	Design	Size
9 x	$\frac{12.9}{16}$ 1/2		M5 · M6 · M7 · M8 · M9 · M10 · M12 · M13 · M14
9 x	$\frac{12.9}{16}$ 1/2		M5 · M6 · M7 · M8 · M9 · M10 · M12 · M13 · M14
7 x	$\frac{12.9}{16}$ 1/2		M8 · M9 · M10 · 10.3 · M12 · M13 · M14
7 x	$\frac{12.9}{16}$ 1/2		M8 · M9 · M10 · M10.3 · M12 · M13 · M14

XX	■	Design	Size
8 x	$\frac{12.9}{16}$ 1/2		M5 · M6 · M8 · M9 · M10 · M12 · M14 · M16
7 x	$\frac{12.9}{16}$ 1/2		M5 · M6 · M8 · M9 · M10 · M12 · M14
7 x	$\frac{12.9}{16}$ 1/2		M5 · M6 · M8 · M10 · M12 · M14 · M9
4 x	$\frac{12.9}{16}$ 1/2		M8 · M10 · M12 · M14

V6810-L, EAN 4047728068109
Soft foam insert · empty

50.13 €
excl. VAT

V6807, EAN 4047728068277
Ratcheting combination wrench set



576.50 €
excl. VAT

XX	Design	Size
18 x		8 · 9 · 10 · 11 · 12 · 13 · 14 · 15 · 16 · 17 · 18 · 19 · 21 · 22 · 24 · 27 · 30 · 32 mm

XX	Design	Size
22 x		6 · 7 · 8 · 9 · 10 · 11 · 12 · 14 · 13 · 15 · 16 · 17 · 18 · 19 · 20 · 21 · 22 · 24 · 27 · 30 · 32 · 36 mm

V6807-L, EAN 4047728068079
Soft foam insert · empty

50.13 €
excl. VAT



V6808, EAN 4047728068291

Double box-end and open-end wrench set

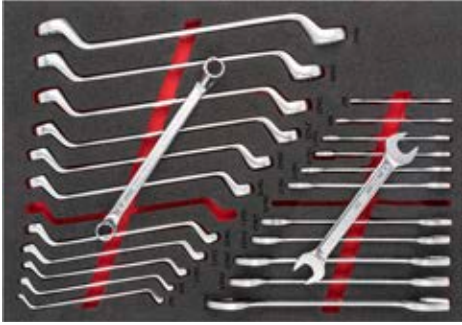

214.50 €
excl. VAT

XX	Design	Size
12 x		6x7 · 8x9 · 10x11 · 12x13 · 14x15 · 16x17 · 18x19 · 20x22 · 21x23 · 24x27 · 25x28 · 30x32 mm

XX	Design	Size
12 x		6x7 · 8x9 · 10x11 · 12x13 · 14x15 · 16x17 · 18x19 · 20x22 · 21x23 · 24x27 · 25x28 · 30x32 mm

V6808-L, EAN 4047728068086

Soft foam insert · empty

50.13 €
excl. VAT

V6813, EAN 4047728068444

Screwdriver set

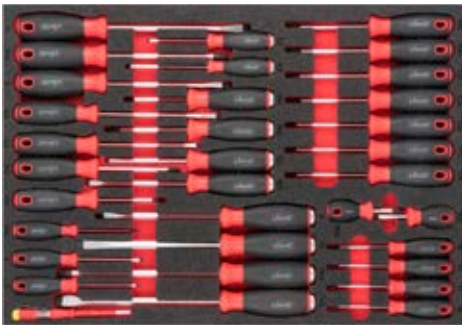

182.- €
excl. VAT

XX	Design	Size
6 x		0.6x3 · 0.8x4 · 1x5.5 · 1.2x6.5 · 1.6x8 · 1.6x10 mm
4 x		PH0 · PH1 · PH2 · PH3
1 x		1x5.5 mm
1 x		PH2

XX	Design	Size
7 x		0.6x3.5 · 1x4.5 · 1x5.5 · 1.2x6.5 · 1.6x8 · 1.6x10 · 2x12 mm
3 x		PH1 · PH2 · PH3
11 x		T6 · T7 · T8 · T9 · T10 · T15 · T20 · T25 · T27 · T30 · T40
1 x		0.5x3 mm

V6813-L, EAN 4047728068130

Soft foam insert · empty

50.13 €
excl. VAT

V6814, EAN 4047728068451

Screwdriver and screwdriver bit set



247.- €
excl. VAT

XX	Design	Size
4 x		1.6 · 2 · 2.4 · 3
2 x		PH0 · PH00
1 x		260 mm
1 x		260 mm
1 x		260 mm
1 x		260 mm
1 x		260 mm
1 x		260 mm
1 x		130 mm
1 x		130 mm
1 x		130 mm
1 x		130 mm

XX	Design	Size
5 x		32 x
5 x		22 x
1 x		200 mm
3 x		6 · 7 · 8 mm
9 x		T10 · T15 · T20 · T25 · T27 · T30 · T40 · T45 · T50
9 x		1.5 · 2 · 2.5 · 3 · 4 · 5 · 6 · 8 · 10
6 x		6 · 7 · 8 · 10 · 12 · 13 mm

V6814-L, EAN 4047728068147

Soft foam insert · empty

50.13 €
excl. VAT

Soft foam inserts



V6815, EAN 4047728068468
Pliers set



376.- €
excl. VAT

XX	Design	Size
1 x		345 mm
1 x		345 mm
1 x		335 mm
1 x		340 mm
1 x		340 mm
1 x		300 mm
1 x		290 mm

XX	Design	Size
1 x		250 mm
1 x		200 mm
1 x		160 mm
1 x		115 mm
1 x		180 mm
1 x		11 x

V6815-L, EAN 4047728068154
Soft foam insert · empty

50.13 €
excl. VAT

V6816, EAN 4047728068475
Pliers set



387.- €
excl. VAT

XX	Design	Size
1 x		16 - 27 mm
1 x		11 - 19 mm
1 x		150 mm
1 x		250 mm
1 x		125 mm
1 x		180 mm
1 x		180 mm
1 x		180 mm
1 x		180 mm
1 x		180 mm

XX	Design	Size
1 x		140 mm
1 x		140 mm
1 x		140 mm
1 x		140 mm
1 x		180 mm
1 x		180 mm
1 x		180 mm
1 x		180 mm

V6816-L, EAN 4047728068161
Soft foam insert · empty

50.13 €
excl. VAT

V6817, EAN 4047728068499
Hammer, chisel and drift pin set



311.50 €
excl. VAT

XX	Design	Size
1 x		800 g
1 x		1500 g
1 x		∅ 32 mm
1 x		645 mm
1 x		10 x
1 x		210 mm
1 x		10 x

XX	Design	Size
1 x		90 mm
1 x		-
6 x		∅ 3 · 4 · 5 · 6 · 8 · 2 mm
1 x		6 mm
1 x		18 mm
1 x		∅ 4 mm
2 x		190 · 170 mm
2 x		∅ 4 · 40 mm
4 x		10 · 16 · 20 · 29 mm
7 x		∅ 2 · 3 · 4 · 5 · 6 · 7 · 8 mm

V6817-L, EAN 4047728068178
Soft foam insert · empty

50.13 €
excl. VAT



V6818, EAN 4047728**068482**
Scraper and release lever set



182.- €
excl. VAT

XX	Design	Size
1 x		165 mm
1 x		5 x
1 x		490 mm
1 x		16 x

XX	Design	Size
1 x		22 mm
1 x		10 x
1 x		4 x
1 x		40 mm

V6818-L, EAN 4047728**068185**
Soft foam insert · empty

50.13 €
excl. VAT

V6811, EAN 4047728**068420**
Impact socket set



721.- €
excl. VAT

XX	Design	Size
15 x		21 · 22 · 24 · 27 · 30 · 32 · 10 · 11 · 12 · 13 · 14 · 15 · 16 · 17 · 19 mm
1 x		-
1 x		-
13 x		10 · 11 · 12 · 13 · 14 · 15 · 16 · 17 · 18 · 19 · 21 · 22 · 24 mm
13 x		10 · 11 · 12 · 13 · 14 · 15 · 16 · 17 · 18 · 19 · 21 · 22 · 24 mm
4 x		24 · 30 · 32 · 36 mm
1 x		-

XX	Design	Size
8 x		T30 · T40 · T45 · T50 · T55 · T60 · T70 · T80
8 x		M5 · M6 · M8 · M10 · M12 · M14 · M16 · M18
8 x		5 · 6 · 8 · 10 · 12 · 14 · 17 · 19 mm
5 x		15 · 17 · 19 · 21 · 22 mm
1 x		17 mm
1 x		19 mm
1 x		78 mm

V6811-L, EAN 4047728**068116**
Soft foam insert · empty

50.13 €
excl. VAT

V6812, EAN 4047728**068437**
Specialty tools for wheels / tyres



430.- €
excl. VAT

XX	Design	Size
1 x		-
1 x		-
1 x		9 mm
1 x		500 mm
1 x		-

XX	Design	Size
1 x		128 mm
1 x		4 x
1 x		118 mm
1 x		250 mm
1 x		540 mm

V6812-L, EAN 4047728**068123**
Soft foam insert · empty

50.13 €
excl. VAT

Soft foam inserts



V4586, EAN 4047728**045865**
Socket tool set for Series XL



409.50 €
excl. VAT

XX	Size	Design	Size
5 x	6.3 1/4		R5 · R6 · R7 · R8 · R9
3 x	6.3 1/4		T5 · T6 · T7
3 x	6.3 1/4		M5 · M6 · M8
9 x	6.3 1/4		T7H · T10H · T15H · T20H · T25H · T27H · T30H · T40H · T45H
6 x	8 9/16		T40 · T45 · T50 · T55 · T60 · T70
5 x	8 9/16		7 · 8 · 10 · 12 · 14 mm
2 x	8 9/16		PH3 · PH4
2 x	8 9/16		PZ3 · PZ4
3 x	8 9/16		1.6x81.6x10-2x12 mm
6 x	8 9/16		T40H · T45H · T50H · T55H · T60H · T70H
4 x	-		1.3 · 1.5 · 2 · 2.5 mm
1 x	10 3/8		28 mm
1 x	6.3 1/4		25 mm
1 x	12 1/2		37 mm
1 x	6.3 1/4		25 mm
1 x	6.3 1/4		110 mm
1 x	-		150 mm
1 x	-		43.7 mm
8 x	12 1/2		T20 · T25 · T27 · T30 · T40 · T45 · T50 · T55
8 x	12 1/2		T27 · T30 · T40 · T45 · T50 · T55 · T60 · T70
8 x	12 1/2		M5 · M6 · M8 · M9 · M10 · M14 · M16 · M12
7 x	12 1/2		M5 · M6 · M8 · M9 · M10 · M12 · M14
8 x	12 1/2		5 · 6 · 7 · 8 · 10 · 12 · 14 · 17 mm
8 x	12 1/2		5 · 6 · 7 · 8 · 10 · 11 · 12 · 13 mm
7 x	6.3 1/4		T9 · T10 · T15 · T20 · T25 · T27 · T30
4 x	6.3 1/4		3 · 4 · 5 · 6 mm
3 x	6.3 1/4		PH0 · PH1 · PH2

XX	Size	Design	Size
3 x	6.3 1/4		PZ0 · PZ1 · PZ2
4 x	6.3 1/4		0.8x4 · 1x5.5 · 1.2x6.5 · 1.2x7 mm
7 x	6.3 1/4		T9H · T10H · T15H · T20H · T25H · T27H · T30H
10 x	10 3/8		10 · 11 · 12 · 13 · 14 · 15 · 16 · 17 · 18 · 19 mm
6 x	10 3/8		10 · 11 · 12 · 13 · 14 · 15 mm
6 x	10 3/8		E10 · E11 · E12 · E14 · E16 · E18
17 x	12 1/2		10 · 11 · 12 · 13 · 14 · 15 · 16 · 17 · 18 · 19 · 20 · 21 · 22 · 24 · 27 · 30 · 32 mm
5 x	12 1/2		16 · 17 · 18 · 19 · 22 mm
2 x	12 1/2		E20 · E24
13 x	6.3 1/4		4 · 4.5 · 5 · 5.5 · 6 · 7 · 8 · 9 · 10 · 11 · 12 · 13 · 14 mm
7 x	6.3 1/4		4 · 5 · 6 · 7 · 8 · 9 · 10 mm
5 x	6.3 1/4		E4 · E5 · E6 · E7 · E8
1 x	-		150 mm
1 x	-		198 mm
1 x	-		250 mm
1 x	6.3 1/4		40 mm
1 x	10 3/8		50 mm
1 x	12 1/2		75 mm
1 x	6.3 1/4		50 mm
1 x	6.3 1/4		100 mm
1 x	10 3/8		125 mm
1 x	12 1/2		125 mm
1 x	12 1/2		250 mm
1 x	10 3/8		18 mm
2 x	12 1/2		16 · 21 mm

V4521, EAN 4047728**045216**
Soft foam insert · empty

61.99 €
excl. VAT



V6650, EAN 4047728067454

Combination, double box-end, double open-end wrench set for Series XL



430.- €
excl. VAT

XX	Design	Size
12 x		6x7 · 8x9 · 10x11 · 12x13 · 14x15 · 16x17 · 18x19 · 20x22 · 21x23 · 24x27 · 25x28 · 30x32 mm
12 x		6x7 · 8x9 · 10x11 · 12x13 · 14x15 · 16x17 · 18x19 · 20x22 · 21x23 · 24x27 · 25x28 · 30x32 mm

XX	Design	Size
12 x		8 · 9 · 10 · 11 · 12 · 13 · 14 · 15 · 16 · 17 · 18 · 19 mm
22 x		6 · 7 · 8 · 9 · 10 · 11 · 12 · 13 · 14 · 15 · 16 · 17 · 18 · 19 · 20 · 21 · 22 · 24 · 27 · 30 · 32 · 36 mm

V6650-L, EAN 4047728066501

Soft foam insert · empty

61.99 €
excl. VAT

V5170, EAN 4047728051712

Screwdriver set for Series XL



221.- €
excl. VAT

XX	Design	Size
4 x		1.6 · 2 · 2.4 · 3
2 x		PH0 · PH00
11 x		T6 · T7 · T8 · T9 · T10 · T15 · T20 · T25 · T27 · T30 · T40
4 x		PH0 · PH1 · PH2 · PH3
3 x		PH1 · PH2 · PH3
1 x		PH2
5 x		0.6x3 · 0.8x4 · 1x5.5 · 1.6x8 · 1.6x10 mm

XX	Design	Size
4 x		0.6x3.5 · 1x4.5 · 1x5.5 · 1.2x6.5 mm
1 x		1x5.5 mm
9 x		T10 · T15 · T20 · T25 · T27 · T30 · T40 · T45 · T50
9 x		1.5 · 2 · 2.5 · 3 · 4 · 5 · 6 · 8 · 10
6 x		6 · 7 · 8 · 10 · 12 · 13 mm
1 x		0.5x3 mm

V5170-L, EAN 4047728051729

Soft foam insert · empty

61.99 €
excl. VAT

V5638, EAN 4047728056410

Pliers, hammer and chisel set for Series XL



430.- €
excl. VAT

XX	Design	Size
1 x		250 mm
1 x		335 mm
1 x		340 mm
1 x		200 mm
1 x		180 mm
1 x		160 mm
1 x		180 mm
1 x		180 mm
1 x		140 mm
1 x		140 mm
1 x		180 mm
1 x		180 mm

XX	Design	Size
1 x		150 mm
1 x		22 mm
6 x		Ø 2 · 3 · 4 · 5 · 6 · 8 mm
1 x		18 mm
1 x		6 mm
1 x		Ø 4 mm
1 x		10 x
1 x		1500 g
1 x		1000 g
1 x		Ø 32 mm
1 x		165 mm
1 x		40 mm

V5638-L, EAN 4047728056007

Soft foam insert · empty

61.99 €
excl. VAT

Soft foam inserts



V6015, EAN 4047728074667
Impact socket set



749.- €
excl. VAT

XX	■	Design	Size	XX	■	Design	Size
1 x	12.5 1/2		19 mm	9 x	12.5 1/2		10 · 11 · 12 · 13 · 14 · 15 · 16 · 17 · 19 mm
1 x	12.5 1/2		17 mm	5 x	12.5 1/2		15 · 17 · 19 · 21 · 22 mm
1 x	-	12.5 1/2	540 mm	8 x	12.5 1/2		5 · 6 · 8 · 10 · 12 · 14 · 17 · 19 mm
1 x	-	12.5 1/2	118 mm	8 x	12.5 1/2		M5 · M6 · M8 · M10 · M12 · M14 · M16 · M18
13 x	12.5 1/2		10 · 11 · 12 · 13 · 14 · 15 · 16 · 17 · 18 · 19 · 21 · 22 · 24 mm	8 x	12.5 1/2		T30 · T40 · T45 · T50 · T55 · T60 · T70 · T80
13 x	12.5 1/2		10 · 11 · 12 · 13 · 14 · 15 · 16 · 17 · 18 · 19 · 21 · 22 · 24 mm				

V6015-L, EAN 4047728074056
Soft foam insert · empty

61,99 €
excl. VAT

V7015, EAN 4047728074636
Hammer, pliers and scraper set for Series XL



430.- €
excl. VAT

XX	Design	Size	XX	Design	Size
1 x		335 mm	1 x		250 mm
1 x		340 mm	1 x		200 mm
1 x		300 mm	1 x		160 mm
1 x		290 mm	1 x		180 mm
1 x		350 mm	2 x		190 · 170 mm
1 x		10 x	1 x		4 x
1 x		90 mm	2 x		∅ 40 · 4 mm
1 x		165 mm	1 x		7 x
1 x		16 x			

V7015-L, EAN 4047728074049
Soft foam insert · empty

61,99 €
excl. VAT



V5009, EAN 4047728**050098**

2-component soft foam insert ·
with empty compartment



27.49 €
excl. VAT

V4631, EAN 4047728**046312**

2-component soft foam insert ·
without cut-out



13.91 €
excl. VAT

V5018, EAN 4047728**050180**

2-component soft foam insert ·
with empty compartment



38.27 €
excl. VAT

V4632, EAN 4047728**046329**

2-component soft foam insert ·
without cut-out



27.92 €
excl. VAT

V4633, EAN 4047728**064347**

2-component soft foam insert ·
without cut-out



32.23 €
excl. VAT

Soft foam inserts

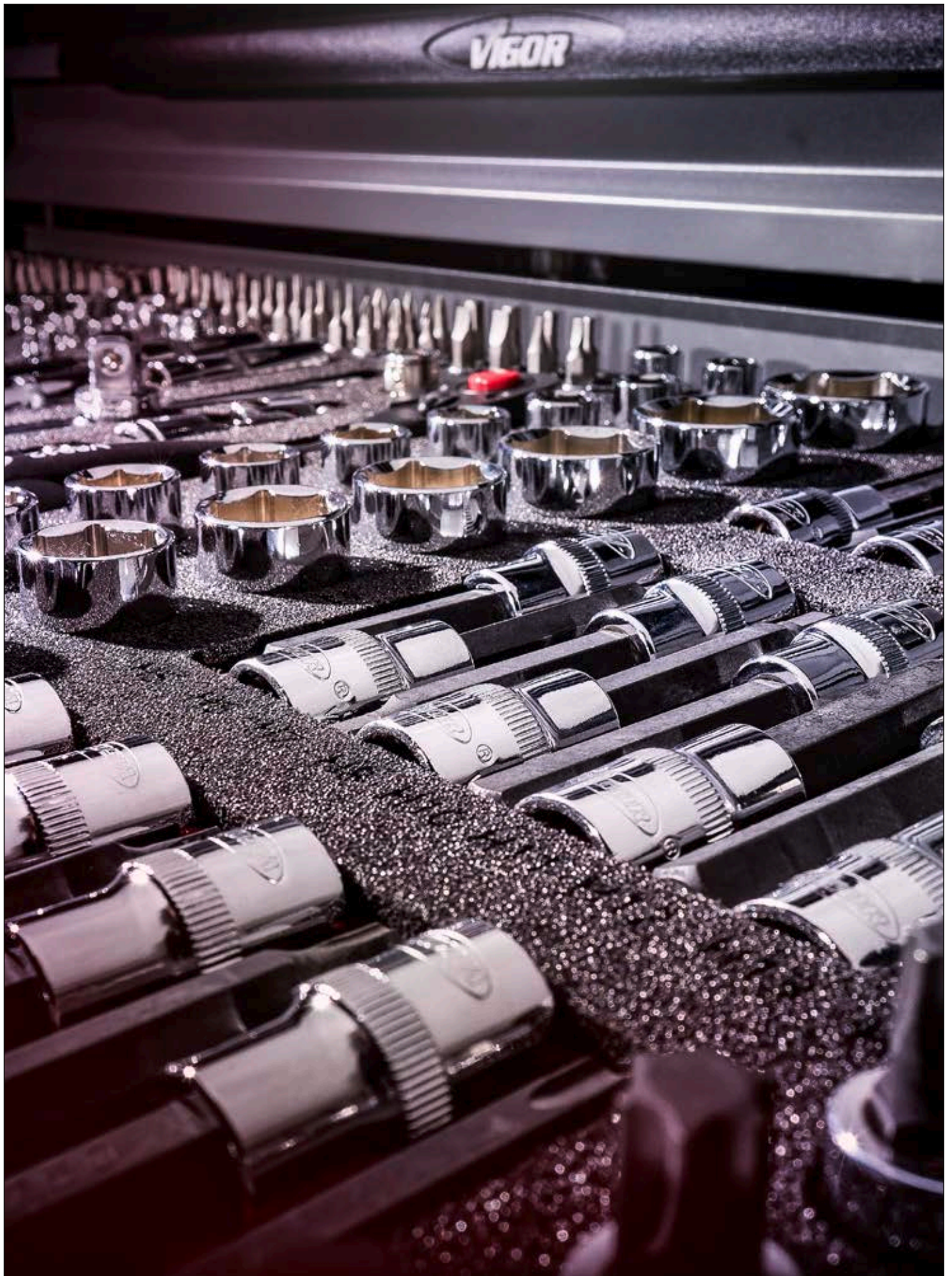



Hand tools

Sockets	124–177
Universal tool cases	178–179
Wrenches	180–190
Screwdrivers and bits	191–202
Pliers	203–212
VDE tools	213–216
Impact and releasing tools, scrapers	217–224
Various hand tools	224–225
Cutting and sawing	225–233



V5202, EAN 4047728**068987**

Socket set · super flat

- Thanks to insert profile – Direct attachment to the nut/screw connection
- Robust solid steel reversible ratchet
- Right and left-hand operation
- Ergonomic handle
- Sockets without chamfered edge
- Super short sockets make it possible to work in very tight spaces
- Throughhole nut-drivers make it possible to work on stud bolts
- Sockets with outside hexagon size 11 mm for operation with box-end wrench or open-end wrench



Single parts from page 128

XX	■	□	Design	Size
3 x	6.3 1/4"	⊖		0.8x4 · 1x5 · 1x6 mm
2 x	6.3 1/4"	⊕		PH1 · PH2
5 x	6.3 1/4"	⊗		T15 · T20 · T25 · T27 · T30
1 x	-	6.3 1/4"		-
1 x	6.3 1/4"	6.3 1/4"		-
13 x	6.3 1/4"	⊙		4 · 4.5 · 5 · 5.5 · 6 · 7 · 8 · 9 · 10 · 11 · 12 · 13 · 14 mm



Including bit holder and bits

80.85 €
excl. VAT

V3734N, EAN 4047728**056427**

Socket set

- For manual operation



Single parts from page 126

XX	■	□	Design	Size
2 x	6.3 1/4"	⊕		PH1 · PH2
2 x	6.3 1/4"	⊕		PZ1 · PZ2
4 x	6.3 1/4"	⊗		T15 · T20 · T25 · T30
1 x	6.3 1/4"	6.3 1/4"		25 mm
12 x	6.3 1/4"	⊙		4 · 4.5 · 5 · 5.5 · 6 · 7 · 8 · 9 · 10 · 11 · 12 · 13 mm
1 x	-	6.3 1/4"		150 mm
1 x	6.3 1/4"	6.3 1/4"		100 mm

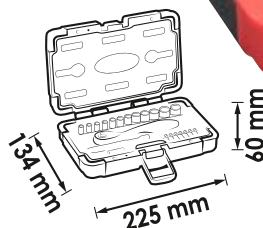

43.01 €
excl. VAT

Sockets



V2414N, EAN 4047728056434

Socket set

• For manual operation



Single parts from page 126

XX	■	●	Design	Size
13 x	6.3 1/4	●		4 · 4.5 · 5 · 5.5 · 6 · 7 · 8 · 9 · 10 · 11 · 12 · 13 · 14 mm
3 x	6.3 1/4	●		0.8x4 · 1x5.5 · 1.2x7 mm
6 x	6.3 1/4	○		3 · 4 · 5 · 6 · 7 · 8 mm
3 x	6.3 1/4	+		PH1 · PH2 · PH3
3 x	6.3 1/4	✦		PZ1 · PZ2 · PZ3
6 x	6.3 1/4	✦		T10 · T15 · T20 · T25 · T30 · T40
4 x	-	○		1.3 · 1.5 · 2 · 2.5 mm
1 x	10 3/8	6.3 1/4		27 mm
1 x	6.3 1/4	6.3 1/4		110 mm
1 x	6.3 1/4	6.3 1/4		50 mm
1 x	6.3 1/4	6.3 1/4		100 mm
1 x	6.3 1/4	6.3 1/4		145 mm
1 x	6.3 1/4	6.3 1/4		40 mm
1 x	-	6.3 1/4		150 mm
1 x	-	6.3 1/4		150 mm

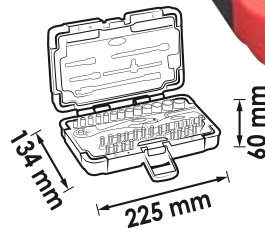

61.12 €

excl. VAT

V7514/13, EAN 4047728074063

12-point socket set



NEW



Single parts see page 129

XX	■	●	Design	Size
13 x	6.3 1/4	●		4 · 4.5 · 5 · 5.5 · 6 · 7 · 8 · 9 · 10 · 11 · 12 · 13 · 14 mm

16.10 €

excl. VAT

V1897, EAN 4047728**018975**

Socket with multi-purpose profile, set

- For manual operation

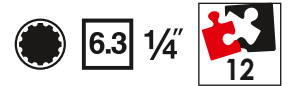

Multi-purpose screw profiles

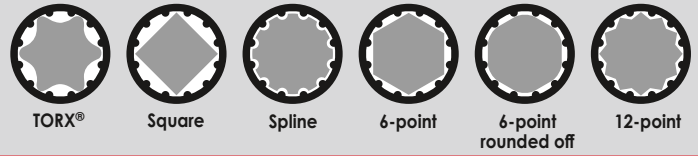

All sockets suitable for 6 different profiles

31.26 €
excl. VAT

Single parts see page 130

XX	Size	Design	Size
12 x	6.3 1/4"		4 · 5.5 · 5 · 6 · 7 · 8 · 9 · 10 · 11 · 12 · 13 · 14 mm

V6014, EAN 4047728**055833**

Fine-tooth reversible ratchet

- Offset design
- Plastic coating
- Quick-release press-button
- 72 teeth
- 5° Opening angle
- For manual operation



30.72 €
excl. VAT

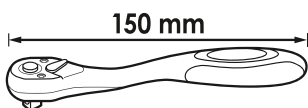

6.3 1/4"

V6014-REP, EAN 4047728**056519**

Repair set

- Repair set for fine-tooth reversible ratchet V6014



11.43 €
excl. VAT

V6614, EAN 4047728**066440**

Telescopic reversible ratchet with hinge joint

- Telescopic range 175 – 225 mm
- 180° swivel head with locking mechanism
- Quick-release press-button
- 72 teeth
- 5° Opening angle
- For manual operation

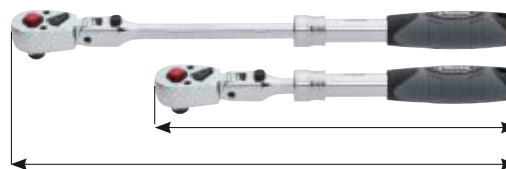

38.48 €
excl. VAT

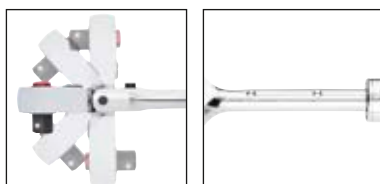

Latches in 5 positions

Can be adjusted to various fixing points

V6614-REP, EAN 4047728**067980**

Repair set

- Repair set for telescopic reversible ratchet with hinge joint V6614



11.- €
excl. VAT

Sockets



V4944-S, EAN 4047728055345

Fine-tooth reversible ratchet · standard

- Robust and service-friendly
- Closed system
- Easy to clean
- 72 teeth
- 5° Opening angle
- For manual operation



37.62 €
excl. VAT

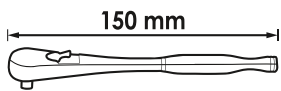

6.3 1/4

V4944-REP, EAN 4047728049474

Repair set

- Repair set for fine-tooth reversible ratchets V4944 · V4944-S · V4944-XS



22.10 €
excl. VAT

V4944-XS, EAN 4047728069557

Fine-tooth reversible ratchet · extra-short design

- Robust and service-friendly
- Closed system
- Easy to clean
- 72 teeth
- 5° Opening angle
- For manual operation

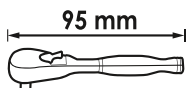

6.3 1/4



35.47 €
excl. VAT

V5436, EAN 4047728054362

360° rotary handle reversible ratchet

- Use in areas with restricted access
- Sliding square for clockwise/anti-clockwise operation
- Standard operation possible through locking function
- Only clockwise operation
- 72 teeth
- 5° Opening angle
- For manual operation



Loosening and tightening of screw connections only in locked mode



Actuator mechanism in the 360° rotary handle

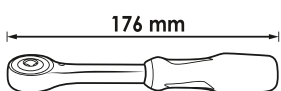

6.3 1/4

44.74 €
excl. VAT



V2941, EAN 4047728029414

Finger ratchet

- 1/4" 6.3 Finger ratchet, individual, for screwdriver bits
- 72 teeth
- 5° Opening angle
- For manual operation

6.3 1/4"

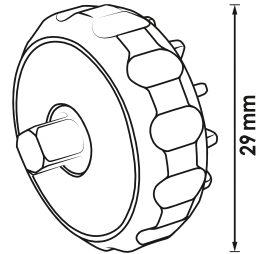

16.71 €
excl. VAT

V5202-1, EAN 4047728069366

Reversible ratchet

- Thanks to insert profile – Direct attachment to the nut/screw connection
- Robust solid steel reversible ratchet
- Right and left-hand operation
- Ergonomic handle

6.3 1/4" 6.3 1/4"

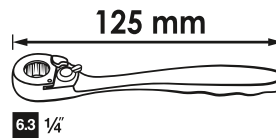

32.23 €
excl. VAT

Spin type speeder

6.3 1/4"



VIGOR No.	mm	EAN 4047728+	€
V2458N	150	058179	7.65

Sliding T-handle

6.3 1/4" 6.3 1/4"



VIGOR No.	mm	EAN 4047728+	€
V2453N	110	058124	4.31

Sockets



Socket



VIGOR No.	Size	l mm	EAN 4047728+	€
V2413N	4 mm	25	057738	2.26
V2415N	4.5 mm	25	057745	2.26
V2416N	5 mm	25	057752	2.26
V2417N	5.5 mm	25	057769	2.26
V2418N	6 mm	25	057776	2.26
V2419N	7 mm	25	057783	2.26
V2420N	8 mm	25	057790	2.26

VIGOR No.	Size	l mm	EAN 4047728+	€
V2421N	9 mm	25	057806	2.26
V2422N	10 mm	25	057813	2.26
V2423N	11 mm	25	057820	2.26
V2424N	12 mm	25	057837	2.26
V2425N	13 mm	25	057844	2.48
V2426N	14 mm	25	057851	2.80

12-point socket



VIGOR No.	Size	l mm	EAN 4047728+	€
V7514-4	4 mm	25	074070	2.26
V7514-4.5	4.5 mm	25	074087	2.26
V7514-5	5 mm	25	074094	2.26
V7514-5.5	5.5 mm	25	074100	2.26
V7514-6	6 mm	25	074117	2.26
V7514-7	7 mm	25	074124	2.26
V7514-8	8 mm	25	074131	2.26

VIGOR No.	Size	l mm	EAN 4047728+	€
V7514-9	9 mm	25	074148	2.26
V7514-10	10 mm	25	074155	2.26
V7514-11	11 mm	25	074162	2.26
V7514-12	12 mm	25	074179	2.26
V7514-13	13 mm	25	074186	2.48
V7514-14	14 mm	25	074193	2.80

Socket · long



VIGOR No.	Size	l mm	EAN 4047728+	€
V2533N	4 mm	50	058193	3.23
V2534N	5 mm	50	058209	3.23
V2535N	6 mm	50	058216	3.23
V2536N	7 mm	50	058223	3.23
V2537N	8 mm	50	058230	3.23

VIGOR No.	Size	l mm	EAN 4047728+	€
V2538N	9 mm	50	058247	3.23
V2539N	10 mm	50	058254	3.23
V2699N	11 mm	50	058735	3.23
V2700N	12 mm	50	058742	3.23
V2701N	13 mm	50	058759	3.23

Socket · super flat



VIGOR No.	Size	EAN 4047728+	€
V5202-4	4 mm	069380	3.77
V5202-4.5	4.5 mm	069397	3.77
V5202-5	5 mm	069403	3.77
V5202-5.5	5.5 mm	069410	3.77
V5202-6	6 mm	069427	3.77
V5202-7	7 mm	069434	3.77
V5202-8	8 mm	069441	3.77

VIGOR No.	Size	EAN 4047728+	€
V5202-9	9 mm	069458	3.77
V5202-10	10 mm	069465	3.77
V5202-11	11 mm	069472	3.77
V5202-12	12 mm	069489	3.77
V5202-13	13 mm	069496	3.77
V5202-14	14 mm	069502	4.20

TORX® socket



VIGOR No.	Size	l mm	EAN 4047728+	€
V2185	E4	24.8	021852	3.45
V2186	E5	24.8	021869	3.45
V2187	E6	24.8	021876	3.45
V2188	E7	24.8	021883	3.45
V2189	E8	24.8	021890	3.45
V2722	E10	24.8	027229	4.10
V2723	E11	24.8	027236	4.10

Socket with multi-purpose profile



VIGOR No.	Size	L mm	EAN 4047728+	€
V1976	4 mm	25	019767	2.91
V1977	5 mm	25	019774	2.91
V1979	6 mm	25	019798	2.91
V1980	7 mm	25	019804	2.91
V1981	8 mm	25	019811	2.91
V1982	9 mm	25	019828	2.91

VIGOR No.	Size	L mm	EAN 4047728+	€
V1983	10 mm	25	019835	2.91
V1984	11 mm	25	019842	2.91
V1985	12 mm	25	019859	2.91
V1986	13 mm	25	019866	2.91
V1987	14 mm	25	019873	2.91

TORX® screwdriver socket



VIGOR No.	Size	L mm	EAN 4047728+	€
V2595N	T9	38	058599	2.26
V2442N	T10	38	058018	2.26
V2443N	T15	38	058025	2.26
V2444N	T20	38	058032	2.26

VIGOR No.	Size	L mm	EAN 4047728+	€
V2445N	T25	38	058049	2.26
V2130N	T27	38	057042	2.26
V2446N	T30	38	058056	2.26
V2447N	T40	38	058063	2.26

Screwdriver socket



VIGOR No.	Size	L mm	EAN 4047728+	€
V2596N	T9H	38	058605	2.91
V2136	T10H	37	021364	2.26
V2138	T15H	37	021388	2.26
V2139	T20H	37	021395	2.26
V2140	T25H	37	021401	2.26
V2141	T27H	37	021418	2.26
V2142	T30H	37	021425	2.26

Screwdriver socket



VIGOR No.	Size	L mm	EAN 4047728+	€
V2593N	PH0	38	058575	2.48
V2436N	PH1	38	057950	2.48
V2437N	PH2	38	057967	2.48
V2438N	PH3	38	057974	2.48

Screwdriver socket



VIGOR No.	Size	L mm	EAN 4047728+	€
V2594N	PZ0	38	058582	2.48
V2439N	PZ1	38	057981	2.48
V2440N	PZ2	38	057998	2.48
V2441N	PZ3	38	058001	2.48

Sockets



Screwdriver socket

6.3 1/4"



VIGOR No.	Size	mm	EAN 4047728+	€
V2427N	0.8x4 mm	38	057868	2.48
V2428N	1x5.5 mm	38	057875	2.48
V2597N	1.2x6.5 mm	38	058612	2.48
V2429N	1.2x7 mm	38	057882	2.48

Screwdriver socket

6.3 1/4"



VIGOR No.	Size	mm	EAN 4047728+	€
V2430N	3 mm	38	057899	2.48
V2431N	4 mm	38	057905	2.48
V2432N	5 mm	38	057912	2.48
V2433N	6 mm	38	057929	2.48
V2434N	7 mm	38	057936	2.48
V2435N	8 mm	38	057943	2.48

Universal joint

6.3 1/4" 6.3 1/4"



VIGOR No.	mm	EAN 4047728+	€
V2454N	40	058131	6.14

Flexible extension

6.3 1/4" 6.3 1/4"



VIGOR No.	mm	EAN 4047728+	€
V2457N	145	058162	6.14

Wobble extension

- Operating screw connections in confined spaces and working in areas with restricted access
- Spherical, tapered outside square



6.3 1/4" 6.3 1/4"

VIGOR No.	mm	EAN 4047728+	€
V4311	36	043113	4.42
V4312	75	043120	5.61
V4313	250	043137	11.10



Extension

6.3 1/4" 6.3 1/4"



VIGOR No.	mm	EAN 4047728+	€
V2455N	50	058148	3.23
V2456N	100	058155	4.31

Adapter

10 3/8" 6.3 1/4"



VIGOR No.	mm	EAN 4047728+	€
V2014	26	020145	1.94

Adapter

6.3 1/4" 6.3 1/4"



VIGOR No.	mm	EAN 4047728+	€
V2452N	25	058117	2.26

Bit adapter

6.3 1/4" 6.3 1/4"



VIGOR No.	mm	EAN 4047728+	€
V3651N	25	058872	2.26

Bit adapter

6.3 1/4" 6.3 1/4"

- Thanks to insert profile – Direct attachment to the nut/screw connection
- Optional drive outside hexagon 11 mm or inside square 6.3 mm (1/4 inches)
- Drive inside hexagon 6.3 mm (1/4 inches) for bits
- For manual operation



VIGOR No.	EAN 4047728+	€
V5202-2	069373	5.28

Sockets



V6202, EAN 4047728062022

Socket set · super flat

- Thanks to insert profile – direct attachment to the nut/screw connection
- Robust solid steel reversible ratchet
- Right and left-hand operation
- Ergonomic handle
- Sockets without chamfered edge
- Super short sockets make it possible to work in very tight spaces
- Sockets with outside hexagon size 17 mm for operation with box-end wrench or open-end wrench

Your problem solver for flat screw connections and tight spaces

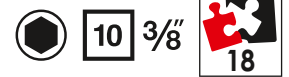

Without chamfered edge!
For low screw head heights



122.-€
excl. VAT

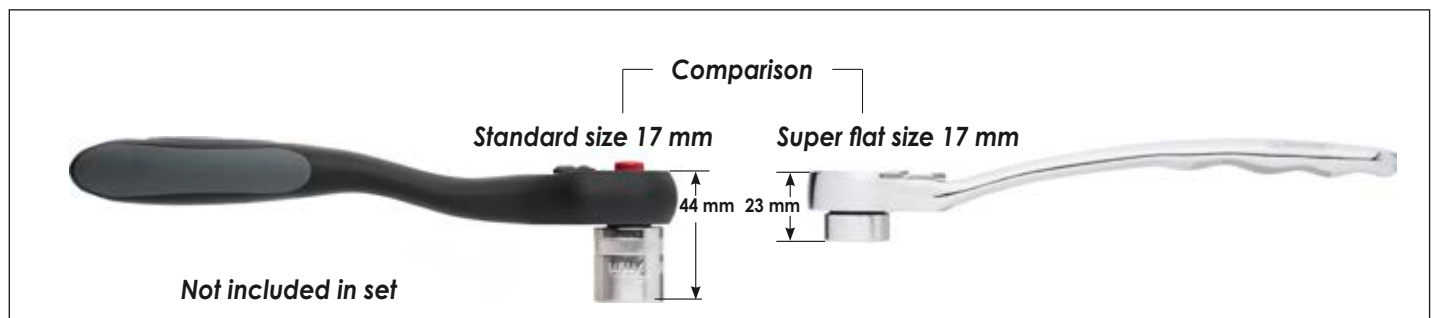

Single parts from page 137

xx	■	Design	Size
1 x	-		200 mm
1 x	17 mm		30 mm
1 x	10 3/8		60 mm
1 x	10 3/8		75 mm
1 x	10 3/8		150 mm
13 x	10 3/8		8 · 9 · 10 · 11 · 12 · 13 · 14 · 15 · 16 · 17 · 19 · 21 · 22 mm



V2305N, EAN 4047728**056441**

Socket set

• For manual operation

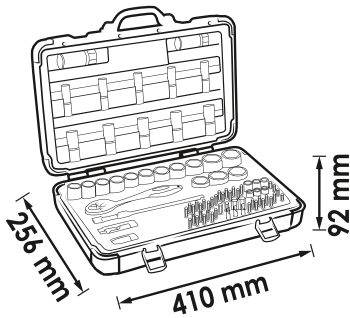

106.50 €
excl. VAT

Single parts from page 136

XX	■	●	Design	Size
18 x	10 3/8	●		6 · 7 · 8 · 9 · 10 · 11 · 12 · 13 · 14 · 15 · 16 · 17 · 18 · 19 · 20 · 21 · 22 · 24 mm
10 x	10 3/8	●		8 · 9 · 10 · 11 · 12 · 13 · 14 · 15 · 17 · 19 mm
2 x	10 3/8	●		16 · 21 mm
7 x	10 3/8	○		3 · 4 · 5 · 6 · 7 · 8 · 10 mm
3 x	10 3/8	◐		0.8x5.5 · 1x7 · 1.2x8 mm
3 x	10 3/8	+		PH1 · PH2 · PH3
3 x	10 3/8	✦		PZ1 · PZ2 · PZ3
9 x	10 3/8	✦		T15 · T20 · T25 · T27 · T30 · T40 · T45 · T50 · T55
1 x	10 3/8	⊕		28 mm
1 x	12 3/8	10 3/8		40 mm
1 x	10 3/8	10 3/8		75 mm
1 x	10 3/8	10 3/8		250 mm
1 x	10 3/8	10 3/8		50 mm
1 x	-	10 3/8		198 mm



Sockets



V7538/10, EAN 4047728074209

12-point socket set

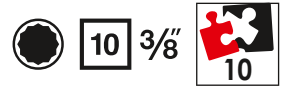

NEW

16.10 €
excl. VAT

Single parts see page 137

XX	■	●	Design	Size
10 x	10 3/8	●		10 · 11 · 12 · 13 · 14 · 15 · 16 · 17 · 18 · 19 mm

V6017, EAN 4047728064361

TORX® screwdriver socket set

- Phosphatized blades
- Chrome-vanadium steel
- Knurling
- For manual operation

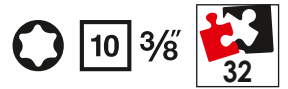

86.13 €
excl. VAT

Single parts from page 139

XX	■	●	Design	Size
8 x	10 3/8	●		T20 · T25 · T27 · T30 · T40 · T45 · T50 · T55
2 x	10 3/8	●		T60 · T70
10 x	10 3/8	●		T20 · T25 · T27 · T30 · T40 · T45 · T50 · T55 · T60 · T70
6 x	10 3/8	●		T40 · T45 · T50 · T55 · T60 · T70
6 x	10 3/8	●		T40 · T45 · T50 · T55 · T60 · T70

V6018, EAN 4047728065894

Screwdriver socket set for screws with internal serration (XZN)

- Phosphatized blades
- Chrome-vanadium steel
- Knurling
- For manual operation

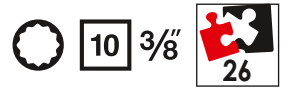

86.13 €
excl. VAT

Single parts from page 141

XX	■	●	Design	Size
8 x	10 3/8	●		M5 · M6 · M8 · M9 · M10 · M12 · M14 · M16
7 x	10 3/8	●		M5 · M6 · M8 · M9 · M10 · M12 · M14
7 x	10 3/8	●		M5 · M6 · M8 · M9 · M10 · M12 · M14
4 x	10 3/8	●		M8 · M10 · M12 · M14

V6019, EAN 4047728065900

Screwdriver socket for inside hexagon screws

- Phosphatized blades
- Chrome-vanadium steel
- Knurling
- For manual operation

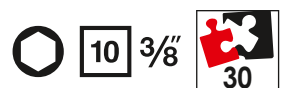

86.13 €
excl. VAT

Single parts from page 142

XX	■	●	Design	Size
5 x	10 3/8	●		5 · 6 · 7 · 8 · 10 mm
4 x	10 3/8	●		12 · 14 · 17 · 19 mm
8 x	10 3/8	●		5 · 6 · 7 · 8 · 10 · 11 · 12 · 13 mm
7 x	10 3/8	●		5 · 6 · 7 · 8 · 10 · 12 · 14 mm
6 x	10 3/8	●		5 · 6 · 7 · 8 · 10 · 12 mm



V6038, EAN 4047728055840

Fine-tooth reversible ratchet

- Offset design
- Plastic coating
- Quick-release press-button
- DIN 3122, ISO 3315
- 72 teeth
- 5° Opening angle
- For manual operation

10 3/8

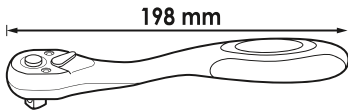

10 3/8

31.15 €
excl. VAT

V6038-REP, EAN 4047728056526

Repair set

- Repair set for fine-tooth reversible ratchet V6038 · V6638



11.43 €
excl. VAT

V6638, EAN 4047728066457

Telescopic reversible ratchet with hinge joint

- Telescopic range 250 – 350 mm
- 180° swivel head with locking mechanism
- Quick-release press-button
- 72 teeth
- 5° Opening angle
- For manual operation

10 3/8

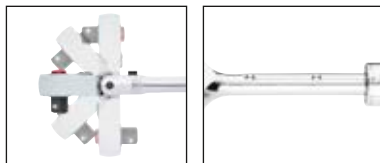

Latches in 5 positions

Can be adjusted to various fixing points

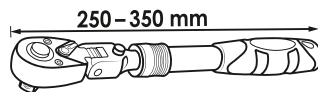

46.35 €
excl. VAT

V4945-S, EAN 4047728055352

Fine-tooth reversible ratchet · standard

- Robust and service-friendly
- Closed system
- Easy to clean
- 72 teeth
- 5° Opening angle
- For manual operation

10 3/8

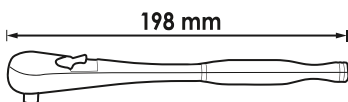
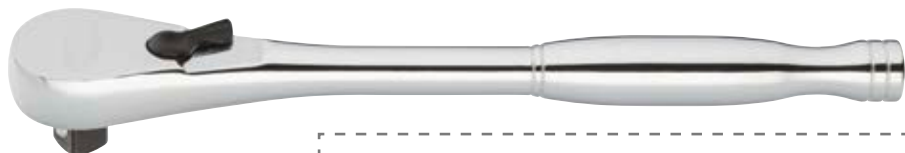

10 3/8

40.96 €
excl. VAT

V4945-REP, EAN 4047728049481

Repair set

- Repair set for fine-tooth reversible ratchets V4945 · V4945-S



22.96 €
excl. VAT

V6008, EAN 4047728060080

360° Rotary handle reversible ratchet

- Use in areas with restricted access
- Sliding square for clockwise/anti-clockwise operation
- Standard operation possible through locking function
- Only clockwise operation
- 72 teeth
- 5° Opening angle
- For manual operation

Loosening and tightening of screw connections only in locked mode

10 3/8



Actuator mechanism in the 360° rotary handle

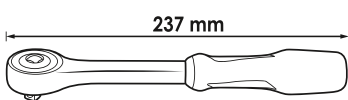

10 3/8

48.40 €
excl. VAT

Sockets



V6202-1, EAN 4047728062640

Reversible ratchet

- Robust solid steel reversible ratchet
- Right and left-hand operation
- Ergonomic handle

10 3/8"



10 3/8"

38.92 €
excl. VAT

Socket

10 3/8"



VIGOR No.	Size	L mm	EAN 4047728+	€
V2278N	6 mm	28	057219	3.13
V2277N	7 mm	28	056908	3.13
V2276N	8 mm	28	056892	3.13
V2275N	9 mm	28	056885	3.13
V2274N	10 mm	28	056878	3.13
V2273N	11 mm	28	056861	3.13
V2272N	12 mm	28	056854	3.13
V2271N	13 mm	28	056847	3.13
V2270N	14 mm	28	056830	3.13

VIGOR No.	Size	L mm	EAN 4047728+	€
V2269N	15 mm	28	057141	3.13
V2268N	16 mm	28	057134	3.13
V2267N	17 mm	30	057127	3.13
V2266N	18 mm	30	057110	3.13
V2265N	19 mm	30	057103	3.13
V2264N	20 mm	30	057097	3.34
V2263N	21 mm	30	057080	3.34
V2262N	22 mm	30	057073	3.34
V2261N	24 mm	30	057066	4.20

12-point socket

NEW

10 3/8"



VIGOR No.	Size	L mm	EAN 4047728+	€
V7538-10	10 mm	28	074230	3.13
V7538-11	11 mm	28	074247	3.13
V7538-12	12 mm	28	074254	3.13
V7538-13	13 mm	28	074261	3.13
V7538-14	14 mm	28	074278	3.13
V7538-15	15 mm	28	074285	3.13
V7538-16	16 mm	28	074292	3.13
V7538-17	17 mm	30	074308	3.13
V7538-18	18 mm	30	074315	3.13
V7538-19	19 mm	30	074322	3.13

Socket · long

10 3/8"



VIGOR No.	Size	L mm	EAN 4047728+	€
V2016N	8 mm	63	056922	4.20
V2017N	9 mm	63	056939	4.20
V2018N	10 mm	63	056946	4.20
V2019N	11 mm	63	056953	4.20
V2020N	12 mm	63	056960	4.20
V2311N	13 mm	63	057509	4.20
V2312N	14 mm	63	057516	5.07
V2313N	15 mm	63	057523	5.07
V2314N	17 mm	63	057530	5.50
V2315N	19 mm	63	057547	6.04

Socket · super flat

10 3/8"



VIGOR No.	Size	L mm	EAN 4047728+	€
V6202-8	8 mm	23	062053	4.20
V6202-9	9 mm	23	062077	4.20
V6202-10	10 mm	23	062091	4.20
V6202-11	11 mm	23	062107	4.20
V6202-12	12 mm	23	062510	4.20
V6202-13	13 mm	23	062534	4.20
V6202-14	14 mm	23	062572	4.85

VIGOR No.	Size	L mm	EAN 4047728+	€
V6202-15	15 mm	23	062589	4.85
V6202-16	16 mm	23	062596	4.85
V6202-17	17 mm	23	062602	5.39
V6202-19	19 mm	23	062220	5.39
V6202-21	21 mm	23	062619	5.39
V6202-22	22 mm	23	062626	5.82

TORX® socket

10 3/8"



VIGOR No.	Size	L mm	EAN 4047728+	€
V2724	E4	28	027243	4.20
V2725	E5	28	027250	4.20
V2726	E6	28	027267	4.20
V2727	E7	28	027274	4.20
V2728	E8	28	027281	4.20
V2143	E10	28	021432	4.20

VIGOR No.	Size	L mm	EAN 4047728+	€
V2614N	E11	28	058674	4.20
V2144	E12	28	021449	4.20
V2145	E14	28	021456	4.20
V2146	E16	28	021463	5.17
V2615N	E18	28	058681	5.17
V2729	E20	28	027298	5.17

Spark Plug Socket

10 3/8"



VIGOR No.	Size	L mm	EAN 4047728+	€
V2119N	16 mm	66	057028	4.20
V2613N	18 mm	66	058667	4.20
V2120N	21 mm	66	057035	4.85

Screwdriver socket

10 3/8"



VIGOR No.	Size	L mm	EAN 4047728+	€
V2288N	0.8x5.5 mm	49	057318	3.45
V2287N	1x7 mm	49	057301	4.20
V2286N	1.2x8 mm	49	057295	4.20

Sockets



Screwdriver socket



VIGOR No.	Size	← L → mm	EAN 4047728+	€
V2291N	PZ1	49	057349	3.45
V2290N	PZ2	49	057332	3.45
V2289N	PZ3	49	057325	3.45

Screwdriver socket



VIGOR No.	Size	← L → mm	EAN 4047728+	€
V2294N	PH1	49	057370	3.45
V2293N	PH2	49	057363	3.45
V2292N	PH3	49	057356	3.45

TORX® screwdriver socket



VIGOR No.	Size	← L → mm	EAN 4047728+	€
V2194	T45H	48	021944	5.17
V2195	T50H	48	021951	5.17

TORX® screwdriver socket



VIGOR No.	Size	← L → mm	EAN 4047728+	€
V6082	T60	48	060820	5.39
V6083	T70	48	060837	5.61



TORX® screwdriver socket



VIGOR No.	Size	L mm	EAN 4047728+	€
V2303N	T15	49	057493	3.45
V2302N	T20	49	057486	3.45
V2301N	T25	49	057479	3.45
V2300N	T27	49	057462	3.45
V2299N	T30	49	057455	3.45
V2298N	T40	49	057448	3.45
V2297N	T45	49	057431	4.20
V2149	T47	49	021494	5.17
V2296N	T50	49	057394	5.17
V2295N	T55	49	057387	5.17

TORX® screwdriver socket



VIGOR No.	Size	L mm	EAN 4047728+	€
V6084	T20	93	060844	5.93
V6085	T25	93	060851	5.93
V6086	T27	93	060868	5.93
V6087	T30	93	060875	5.93
V6088	T40	93	060882	5.93
V6089	T45	93	060899	5.93
V6090	T50	93	060905	5.93
V6091	T55	93	060912	6.04
V6092	T60	93	060929	6.04
V6093	T70	93	060936	6.68

TORX® screwdriver socket



VIGOR No.	Size	L mm	EAN 4047728+	€
V6094	T40	133	060943	6.58
V6095	T45	133	060950	6.58
V6096	T50	133	060967	6.58
V6097	T55	133	060974	6.68
V6098	T60	133	060981	6.68
V6099	T70	133	060998	7.65

TORX® screwdriver socket



VIGOR No.	Size	L mm	EAN 4047728+	€
V6100	T40	193	061001	7.22
V6101	T45	193	061018	7.22
V6102	T50	193	061025	7.22
V6103	T55	193	061032	7.33
V6104	T60	193	061049	8.52
V6105	T70	193	061056	9.81

Sockets



Screwdriver socket



VIGOR No.	Size	mm	EAN 4047728+	€
V6106	M5	48	061063	5.28
V6107	M6	48	061070	5.28
V6108	M8	48	061087	5.28
V6109	M9	48	061094	5.28
V6110	M10	48	061100	5.28
V6111	M12	48	061117	5.28
V6112	M14	48	061124	5.28
V6113	M16	48	061131	5.93

Screwdriver socket



VIGOR No.	Size	mm	EAN 4047728+	€
V6114	M5	93	061148	5.93
V6115	M6	93	061155	5.93
V6116	M8	93	061162	5.93
V6117	M9	93	061179	5.93
V6118	M10	93	061186	5.93
V6119	M12	93	061193	5.93
V6120	M14	93	061209	6.36

Screwdriver socket



VIGOR No.	Size	mm	EAN 4047728+	€
V6121	M5	133	061216	6.58
V6122	M6	133	061223	6.58
V6123	M8	133	061230	6.58
V6124	M9	133	061247	6.68
V6125	M10	133	061254	6.68
V6126	M12	133	061261	7.65
V6127	M14	133	061278	7.76

Screwdriver socket



VIGOR No.	Size	mm	EAN 4047728+	€
V6128	M8	193	061285	7.22
V6129	M10	193	061292	7.44
V6130	M12	193	061308	8.52
V6131	M14	193	061315	9.70



Screwdriver socket

10 3/8"

VIGOR No.	Size	mm	EAN 4047728+	€
V6137	12 mm	48	061377	5.28
V6138	14 mm	48	061384	5.28
V6139	17 mm	48	061391	6.04
V6140	19 mm	48	061407	6.04

Screwdriver socket

10 3/8"

VIGOR No.	Size	mm	EAN 4047728+	€
V2285N	3 mm	49	057288	3.45
V2284N	4 mm	49	057271	3.45
V2283N	5 mm	49	057264	3.45
V2282N	6 mm	49	057257	3.45
V2281N	7 mm	49	057240	4.20
V2280N	8 mm	49	057233	4.20
V2279N	10 mm	49	057226	5.07

Screwdriver socket

10 3/8"

VIGOR No.	Size	mm	EAN 4047728+	€
V6141	5 mm	93	061414	5.50
V6142	6 mm	93	061421	5.50
V6143	7 mm	93	061438	5.50
V6144	8 mm	93	061445	5.50
V6145	10 mm	93	061452	5.50
V6146	11 mm	93	061469	5.50
V6147	12 mm	93	061476	5.50
V6148	13 mm	93	061483	6.14

Screwdriver socket

10 3/8"

VIGOR No.	Size	mm	EAN 4047728+	€
V6149	5 mm	133	061490	6.14
V6194	6 mm	133	062466	6.14
V6151	7 mm	133	061513	6.14
V6152	8 mm	133	061520	6.14
V6153	10 mm	133	061537	6.14
V6154	12 mm	133	061544	6.14
V6155	14 mm	133	061551	7.44

Sockets



Screwdriver socket

10 3/8"



VIGOR No.	Size	mm	EAN 4047728+	€
V6156	5 mm	193	061568	6.90
V6157	6 mm	193	061575	6.90
V6158	7 mm	193	061582	6.90
V6159	8 mm	193	061599	6.90
V6160	10 mm	193	061605	8.19
V6161	12 mm	193	061612	7.65

Universal joint

10 3/8" 10 3/8"



VIGOR No.	mm	EAN 4047728+	€
V2118N	50	057011	6.90

Universal joint

10 3/8" 10 3/8"



VIGOR No.	mm	EAN 4047728+	€
V6202-3	60	062664	8.41

Extension

10 3/8" 10 3/8"



VIGOR No.	mm	EAN 4047728+	€
V2115N	75	056984	4.31
V2616N	125	058698	5.28
V2117N	250	057004	8.95



Wobble extension

- Operating screw connections in confined spaces and working in areas with restricted access
- Spherical, tapered outside square
- Angular movement to each side 8°

10 3/8" 10 3/8"



VIGOR No.	mm	EAN 4047728+	€
V4314	36	043144	5.50
V4315	75	043151	5.82
V4316	250	043168	10.03

Extension

10 3/8" 10 3/8"



VIGOR No.	mm	EAN 4047728+	€
V6202-4	75	062671	6.68
V6202-5	150	062688	7.76

Sliding head / adapter

10 3/8" 12 1/2"



VIGOR No.	mm	EAN 4047728+	€
V2116N	40	056991	4.85

Bit adapter

8 5/16" 10 3/8"



VIGOR No.	mm	EAN 4047728+	€
V2114N	28	056977	3.67

Sockets



Adapter

6.3 1/4 10 3/8



VIGOR No.	mm	EAN 4047728+	€
V2071	27	020718	2.91

Adapter

12.5 1/2 10 3/8



VIGOR No.	mm	EAN 4047728+	€
V2108	36	021081	4.53

Bit adapter

10 3/8 8 5/16



VIGOR No.	mm	EAN 4047728+	€
V3652N	30	058889	2.59

Square adapter

10 3/8

17 mm



VIGOR No.	mm	EAN 4047728+	€
V6202-2	30	062657	11.64



V7202, EAN 4047728**068888**

Socket set · super flat

- Thanks to insert profile – Direct attachment to the nut/screw connection
- Robust solid steel reversible ratchet
- Right and left-hand operation
- Ergonomic handle
- Sockets without chamfered edge
- Super short sockets make it possible to work in very tight spaces
- Throughhole nut-drivers make it possible to work on stud bolts
- Sockets with outside hexagon size 22 mm for operation with box-end wrench or open-end wrench

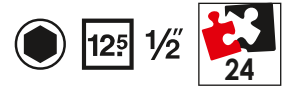

Single parts from page 155

XX	■		Design	Size
1 x	-	12.5 1/2		-
1 x	● 22 mm	12.5 1/2		-
1 x	12.5 1/2	12.5 1/2		-
1 x	12.5 1/2	12.5 1/2		125 mm
1 x	12.5 1/2	12.5 1/2		250 mm
19 x	12.5 1/2	●		8 · 9 · 10 · 11 · 12 · 13 · 14 · 15 · 16 · 17 · 18 · 19 · 20 · 21 · 22 · 24 · 27 · 30 · 32 mm

215.50 €
excl. VAT

V2460N, EAN 4047728**056458**

Socket set

- For manual operation

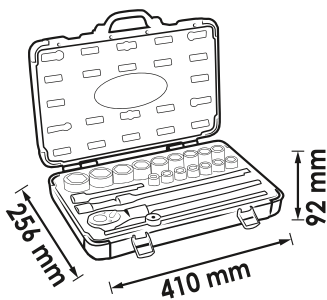
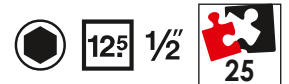

Single parts from page 154

XX	■		Design	Size
18 x	12.5 1/2	●		10 · 11 · 12 · 13 · 14 · 15 · 16 · 17 · 18 · 19 · 20 · 21 · 22 · 23 · 24 · 27 · 30 · 32 mm
2 x	12.5 1/2	●		16 · 21 mm
1 x	-	12.5 1/2		250 mm
1 x	12.5 1/2	12.5 1/2		125 mm
1 x	12.5 1/2	12.5 1/2		250 mm
1 x	12.5 1/2	12.5 1/2		75 mm
1 x	-	12.5 1/2		250 mm

110.- €
excl. VAT

Sockets



V7512/17, EAN 4047728074216
12-point socket set

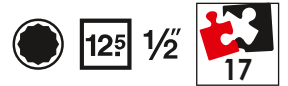

NEW



Single parts see page 156

XX	■	●	Design	Size
17 x	12 5/8	●		10 · 11 · 12 · 13 · 14 · 15 · 16 · 17 · 18 · 19 · 20 · 21 · 22 · 24 · 27 · 30 · 32 mm

43.10 €
excl. VAT

V2496, EAN 4047728024969
Screwdriver socket set
• For manual operation



Single parts from page 157

XX	■	●	Design	Size
8 x	12 5/8	○		M5 · M6 · M8 · M9 · M10 · M12 · M14 · M16
9 x	12 5/8	○		5 · 6 · 7 · 8 · 10 · 12 · 14 · 17 · 19 mm
9 x	12 5/8	●		M5 · M6 · M7 · M8 · M9 · M10 · M12 · M13 · M14
10 x	12 5/8	●		T20 · T25 · T27 · T30 · T40 · T45 · T50 · T55 · T60 · T70

124.- €
excl. VAT



V1917, EAN 4047728019170
TORX® screwdriver socket set

• For manual operation

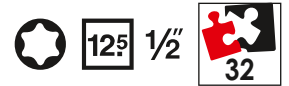

Single parts from page 159

XX	■		Design	Size
10 x	12.5 1/2			T20 · T25 · T27 · T30 · T40 · T45 · T50 · T55 · T60 · T70
10 x	12.5 1/2			T20 · T25 · T27 · T30 · T40 · T45 · T50 · T55 · T60 · T70
6 x	12.5 1/2			T40 · T45 · T50 · T55 · T60 · T70
6 x	12.5 1/2			T40 · T45 · T50 · T55 · T60 · T70

111.-€
excl. VAT

V1918, EAN 4047728019187
Screwdriver socket set for screws with internal serration (XZN)

• For manual operation

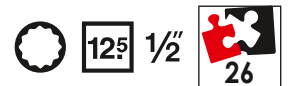

Single parts from page 158

XX	■		Design	Size
8 x	12.5 1/2			M5 · M6 · M8 · M9 · M10 · M12 · M14 · M16
7 x	12.5 1/2			M5 · M6 · M8 · M9 · M10 · M12 · M14
6 x	12.5 1/2			M5 · M6 · M8 · M10 · M12 · M14
4 x	12.5 1/2			M8 · M10 · M12 · M14
1 x	6.3 1/4			T27

111.-€
excl. VAT

Sockets



V1919, EAN 4047728019194

Screwdriver socket set for inside hexagon screws

• For manual operation

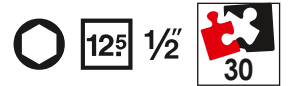

Single parts from page 157

XX	■	○	Design	Size
9 x	12.5 1/2	○		5 · 6 · 7 · 8 · 10 · 12 · 14 · 17 · 19 mm
8 x	12.5 1/2	○		5 · 6 · 7 · 8 · 10 · 11 · 12 · 13 mm
7 x	12.5 1/2	○		5 · 6 · 7 · 8 · 10 · 12 · 14 mm
6 x	12.5 1/2	○		5 · 6 · 7 · 8 · 10 · 12 mm

111.-€
excl. VAT

V2201, EAN 4047728022019

RIBE screwdriver socket set

• For manual operation

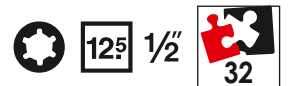

Single parts from page 160

XX	■	⊛	Design	Size
9 x	12.5 1/2	⊛		M5 · M6 · M7 · M8 · M9 · M10 · M12 · M13 · M14
9 x	12.5 1/2	⊛		M5 · M6 · M7 · M8 · M9 · M10 · M12 · M13 · M14
7 x	12.5 1/2	⊛		M8 · M9 · M10 · M10.3 · M12 · M13 · M14
7 x	12.5 1/2	⊛		M8 · M9 · M10 · M10.3 · M12 · M13 · M14

122.-€
excl. VAT



V1898, EAN 4047728018982

Socket with multi-purpose profile, set

• For manual operation

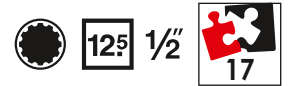

Multi-purpose screw profiles

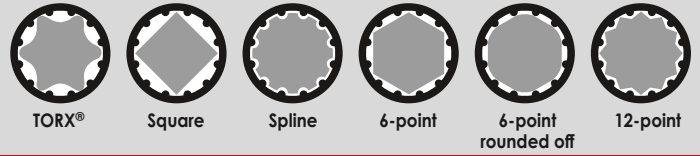

All sockets suitable for 6 different profiles

Single parts see page 157

XX	■	●	Design	Size
17 x	12.5 1/2	●		10 · 11 · 12 · 13 · 14 · 15 · 16 · 17 · 18 · 19 · 20 · 21 · 22 · 24 · 27 · 30 · 32 mm

89.47 €
excl. VAT

V2404, EAN 4047728024044

Extractor socket with spiral profile set

• Operation of nuts with damaged heads (special profile)
• For manual operation

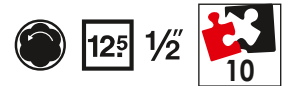

Single parts see page 163

XX	■	●	Design	Size
9 x	12.5 1/2	●		10 · 11 · 12 · 13 · 14 · 15 · 16 · 17 · 19 mm

113.- €
excl. VAT

Sockets



V3741, EAN 4047728037419

Extractor socket with spiral profile set

- Operation of nuts with damaged heads (special profile)
- For manual operation

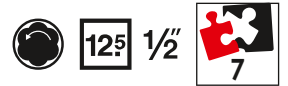

Single parts see page 163

XX	■	●	Design	Size
6 x	12.5	1/2"		21 · 22 · 24 · 27 · 30 · 32 mm

122.- €
excl. VAT

V5550S, EAN 4047728055819

Impact socket set · short

- Surface: phosphatized
- For impact operation

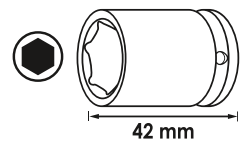
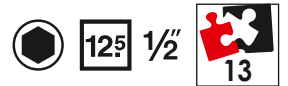

Single parts see page 163

XX	■	●	Design	Size
13 x	12.5	1/2"		10 · 11 · 12 · 13 · 14 · 15 · 16 · 17 · 18 · 19 · 21 · 22 · 24 mm

56.06 €
excl. VAT



V5550L, EAN 4047728055505

Impact socket set · long

- Surface: phosphatized
- For impact operation

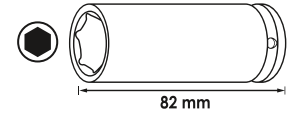
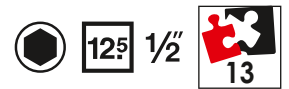

Single parts see page 163

XX	■	●	Design	Size
13 x	12.5 1/2	●		10 · 11 · 12 · 13 · 14 · 15 · 16 · 17 · 18 · 19 · 21 · 22 · 24 mm

84.08 €
excl. VAT

V7017, EAN 4047728064705

Impact screwdriver socket set for internal TORX® profile

- Surface: phosphatized
- For impact operation

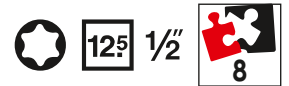

Single parts see page 165

XX	■	●	Design	Size
8 x	12.5 1/2	●		T30 · T40 · T45 · T50 · T55 · T60 · T70 · T80

86.24 €
excl. VAT

Sockets



V7018, EAN 4047728**066846**

Impact screwdriver socket set for internal serration profile (XZN)

- Surface: phosphatized
- For impact operation

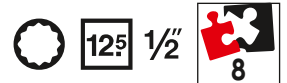

Single parts see page 165

XX	■	○	Design	Size
8 x	12.5 1/2	○		M5 · M6 · M8 · M10 · M12 · M14 · M16 · M18

87.32 €
excl. VAT

V7019, EAN 4047728**066372**

Impact screwdriver socket set for inside hexagon profile

- Surface: phosphatized
- For impact operation

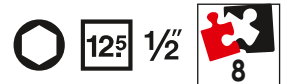

Single parts see page 165

XX	■	○	Design	Size
8 x	12.5 1/2	○		5 · 6 · 8 · 10 · 12 · 14 · 17 · 19 mm

87.32 €
excl. VAT



V6012, EAN 4047728055826

Fine-tooth reversible ratchet

- Offset design
- Plastic coating
- Quick-release press-button
- DIN 3122, ISO 3315
- 72 teeth
- 5° Opening angle
- For manual operation



12⁵ 1/2"

44.74 €
excl. VAT

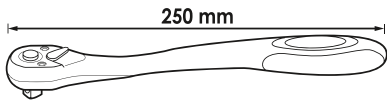

12⁵ 1/2"

V6612, EAN 4047728066464

Telescopic reversible ratchet with hinge joint

- Telescopic range 350 – 490 mm
- 180° swivel head with locking mechanism
- Quick-release press-button
- 72 teeth
- 5° Opening angle
- For manual operation

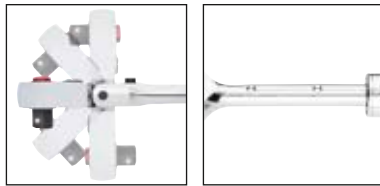

Latches in 5 positions

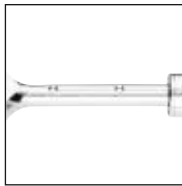

Can be adjusted to various fixing points

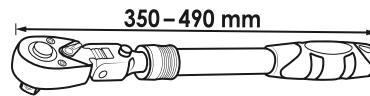

12⁵ 1/2"

64.68 €
excl. VAT

V6012-REP, EAN 4047728056533

Repair set

- Repair set for fine-tooth reversible ratchet V6012 · V6612



11.43 €
excl. VAT

V4946-S, EAN 4047728055369

Fine-tooth reversible ratchet · standard

- Robust and service-friendly
- Closed system
- Easy to clean
- DIN 3122, ISO 3315
- 72 teeth
- 5° Opening angle
- For manual operation



12⁵ 1/2"

63.60 €
excl. VAT

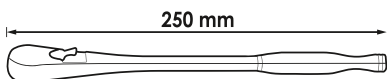

12⁵ 1/2"

Closed system



Sturdy solid steel design



V5437, EAN 4047728054379

360° rotary handle reversible ratchet

- Use in areas with restricted access
- Sliding square for clockwise/anti-clockwise operation
- Standard operation possible through locking function
- Only clockwise operation
- 72 teeth
- 5° Opening angle
- For manual operation

Loosening and tightening of screw connections only in locked mode



Actuator mechanism in the handle

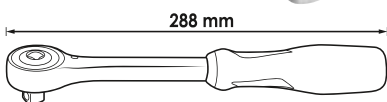

12⁵ 1/2"

65.54 €
excl. VAT

Sockets



V4884, EAN 4047728048842

Flexible handle with reversible ratchet

- Square drive with ball locking device
- DIN 3122
- 24 teeth
- 15° Opening angle
- For manual operation



Robust 24-tooth ratchet mechanism

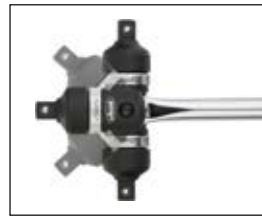

180°

12⁵ 1/2"

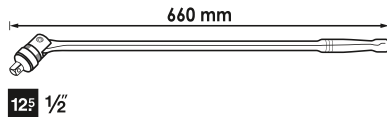

12⁵ 1/2"

V4884-01, EAN 4047728073226

Ratchet head



29.90 €

77.62 €
excl. VAT

V7202-1, EAN 4047728069113

Reversible ratchet

- Thanks to insert profile – Direct attachment to the nut/screw connection
- Robust solid steel reversible ratchet
- Right and left-hand operation
- Ergonomic handle



22 mm



12⁵ 1/2"

12⁵ 1/2"

59.29 €
excl. VAT



Sliding T-handle



12⁵ 1/2"

VIGOR No.	mm	EAN 4047728+	€
V2573N	250	058391	9.49

Sliding piece



12⁵ 1/2"

VIGOR No.	mm	EAN 4047728+	€
V2667N	43.7	058728	6.14

Socket



VIGOR No.	Size	L mm	EAN 4047728+	€
V4709N	8 mm	38	058902	3.45
V2465N	10 mm	38	058186	3.45
V2598N	11 mm	38	058629	3.45
V2603N	12 mm	38	058650	3.45
V2599N	13 mm	38	058636	3.45
V2600N	14 mm	38	058643	3.45
V2561N	15 mm	38	058261	3.45
V2562N	16 mm	38	058278	3.45
V2563N	17 mm	38	058285	3.67
V2564N	18 mm	38	058292	3.67

VIGOR No.	Size	L mm	EAN 4047728+	€
V2565N	19 mm	38	058308	3.88
V2566N	20 mm	38	058315	4.20
V2567N	21 mm	38	058322	4.42
V2568N	22 mm	38	058339	4.64
V2569N	23 mm	38	058346	4.96
V2570N	24 mm	38	058353	5.28
V2571N	27 mm	42	058360	6.79
V2572N	30 mm	44	058377	7.76
V2574N	32 mm	44	058384	8.09

12-point socket



VIGOR No.	Size	L mm	EAN 4047728+	€
V7512-8	8 mm	38	074339	3.45
V7512-10	10 mm	38	074346	3.45
V7512-11	11 mm	38	074353	3.45
V7512-12	12 mm	38	074360	3.45
V7512-13	13 mm	38	074377	3.45
V7512-14	14 mm	38	074384	3.45
V7512-15	15 mm	38	074391	3.45
V7512-16	16 mm	38	074407	3.45
V7512-17	17 mm	38	074414	3.67
V7512-18	18 mm	38	074421	3.67

VIGOR No.	Size	L mm	EAN 4047728+	€
V7512-19	19 mm	38	074438	3.88
V7512-20	20 mm	38	074445	4.20
V7512-21	21 mm	38	074452	4.42
V7512-22	22 mm	38	074469	4.64
V7512-23	23 mm	38	074476	4.96
V7512-24	24 mm	38	074483	5.28
V7512-27	27 mm	42	074490	6.79
V7512-30	30 mm	44	074506	7.76
V7512-32	32 mm	44	074513	8.09

Socket · long



VIGOR No.	Size	L mm	EAN 4047728+	€
V2579N	10 mm	77	058445	6.14
V2580N	11 mm	77	058452	6.14
V2581N	12 mm	77	058469	5.50
V2584N	13 mm	77	058483	5.50
V2585N	14 mm	77	058490	5.39
V2586N	15 mm	77	058506	5.39
V2587N	16 mm	77	058513	5.71
V2588N	17 mm	77	058520	6.14
V2589N	18 mm	77	058537	6.25
V2590N	19 mm	77	058544	6.47
V2591N	22 mm	77	058551	7.11

Socket · super flat

• Thanks to insert profile – Direct attachment to the nut/screw connection



VIGOR No.	Size	EAN 4047728+	€
V7202-8	8 mm	069168	6.14
V7202-9	9 mm	069083	6.04
V7202-10	10 mm	069090	6.04
V7202-11	11 mm	069106	6.04
V7202-12	12 mm	069212	6.04
V7202-13	13 mm	069229	6.04
V7202-14	14 mm	069236	6.04
V7202-15	15 mm	069243	6.04
V7202-16	16 mm	069250	6.04
V7202-17	17 mm	069267	6.04

VIGOR No.	Size	EAN 4047728+	€
V7202-18	18 mm	069274	6.04
V7202-19	19 mm	069281	6.04
V7202-20	20 mm	069298	6.47
V7202-21	21 mm	069304	7.11
V7202-22	22 mm	069311	7.11
V7202-24	24 mm	069328	7.11
V7202-27	27 mm	069335	7.55
V7202-30	30 mm	069342	8.19
V7202-32	32 mm	069359	8.73

Sockets



TORX® socket



VIGOR No.	Size	mm	EAN 4047728+	€
V2730	E10	38	027304	5.71
V2731	E11	38	027311	5.71
V2732	E12	38	027328	5.71
V2733	E14	38	027335	6.04
V2734	E16	38	027342	6.04

VIGOR No.	Size	mm	EAN 4047728+	€
V2196	E18	38.2	021968	6.47
V2197	E20	38.2	021975	6.47
V2735	E22	38	027359	6.47
V2592N	E24	38	058568	7.11

Spark Plug Socket



VIGOR No.	Size	mm	EAN 4047728+	€
V2578N	16 mm	66	058438	5.71
V2582N	21 mm	66	058476	6.79

Socket with multi-purpose profile



VIGOR No.	Size	mm	EAN 4047728+	€
V1988	10 mm	38.1	019880	4.20
V1989	11 mm	38.1	019897	4.20
V1990	12 mm	38.1	019903	4.20
V1991	13 mm	38.1	019910	4.20
V1992	14 mm	38.1	019927	4.20
V1993	15 mm	38.1	019934	4.20
V1994	16 mm	38.1	019941	5.28
V1995	17 mm	38.1	019958	5.28
V1996	18 mm	38.1	019965	5.28

VIGOR No.	Size	mm	EAN 4047728+	€
V1997	19 mm	38.1	019972	5.28
V1998	20 mm	38.1	019989	5.39
V1999	21 mm	38.1	019996	5.82
V2000	22 mm	38.1	020008	5.82
V2001	24 mm	40	020015	6.68
V2002	27 mm	42	020022	8.95
V2003	30 mm	45	020039	9.49
V2004	32 mm	45	020046	9.49

Screwdriver sockets for inside hexagon screws



VIGOR No.	Size	mm	EAN 4047728+	€
V2101	5 mm	55	021012	6.36
V2102	6 mm	55	021029	6.36
V2103	7 mm	55	021036	6.36
V2104	8 mm	55	021043	6.36
V2105	10 mm	55	021050	6.36

VIGOR No.	Size	mm	EAN 4047728+	€
V2106	12 mm	55	021067	6.36
V2107	14 mm	55	021074	6.36
V2069	17 mm	55	020695	7.87
V2070	19 mm	55	020701	7.87

Screwdriver sockets for inside hexagon screws



VIGOR No.	Size	mm	EAN 4047728+	€
V2072	5 mm	100	020725	7.11
V2073	6 mm	100	020732	7.11
V2074	7 mm	100	020749	7.11
V2075	8 mm	100	020756	7.11

VIGOR No.	Size	mm	EAN 4047728+	€
V2076	10 mm	100	020763	7.11
V2077	11 mm	100	020770	7.11
V2078	12 mm	100	020787	7.11
V2079	13 mm	100	020794	7.87

Screwdriver sockets for inside hexagon screws



VIGOR No.	Size	mm	EAN 4047728+	€
V2080	5 mm	140	020800	7.87
V2081	6 mm	140	020817	7.87
V2082	7 mm	140	020824	7.87
V2083	8 mm	140	020831	7.87
V2084	10 mm	140	020848	7.87
V2085	12 mm	140	020855	7.87
V2086	14 mm	140	020862	8.62

Screwdriver sockets for inside hexagon screws



VIGOR No.	Size	mm	EAN 4047728+	€
V2087	5 mm	200	020879	8.62
V2088	6 mm	200	020886	8.62
V2089	7 mm	200	020893	8.62
V2090	8 mm	200	020909	8.62
V2091	10 mm	200	020916	8.62
V2092	12 mm	200	020923	8.62

Screwdriver socket for screws with internal serration (XZN)



VIGOR No.	Size	mm	EAN 4047728+	€
V2094	M5	55	020947	6.36
V2095	M6	55	020954	6.36
V2096	M8	55	020961	6.36
V2097	M9	55	020978	6.36

VIGOR No.	Size	mm	EAN 4047728+	€
V2098	M10	55	020985	6.36
V2099	M12	55	020992	6.90
V2065	M14	55	020657	7.11
V2100	M16	55	021005	7.87

Screwdriver socket for screws with internal serration (XZN)



VIGOR No.	Size	mm	EAN 4047728+	€
V2066	M5	100	020664	7.11
V2068	M6	100	020688	7.11
V2067	M8	100	020671	7.11
V2113	M9	100	021135	7.11
V2059	M10	100	020596	7.11
V2060	M12	100	020602	7.11
V2121	M14	100	021210	7.87

Screwdriver socket for screws with internal serration (XZN)



VIGOR No.	Size	mm	EAN 4047728+	€
V2122	M5	140	021227	7.87
V2124	M6	140	021241	7.87
V2123	M8	140	021234	7.87
V2126	M9	140	021265	7.87
V2128	M10	140	021289	7.87
V2129	M12	140	021296	7.87
V2132	M14	140	021326	8.62

Sockets



Screwdriver socket for screws with internal serration (XZN)



VIGOR No.	Size	Length mm	EAN 4047728+	€
V2133	M8	200	021333	8.62
V2134	M10	200	021340	8.62
V2135	M12	200	021357	8.62
V2137	M14	200	021371	9.59

TORX® screwdriver socket



VIGOR No.	Size	Length mm	EAN 4047728+	€	VIGOR No.	Size	Length mm	EAN 4047728+	€
V2151	T20	55	021517	6.36	V2156	T45	55	021562	6.36
V2152	T25	55	021524	6.36	V2157	T50	55	021579	6.36
V2153	T27	55	021531	6.36	V2158	T55	55	021586	6.36
V2154	T30	55	021548	6.36	V2159	T60	55	021593	6.36
V2155	T40	55	021555	6.36	V2160	T70	55	021609	7.11

TORX® screwdriver socket



VIGOR No.	Size	Length mm	EAN 4047728+	€	VIGOR No.	Size	Length mm	EAN 4047728+	€
V2161	T20	100	021616	7.11	V2168	T45	100	021685	7.11
V2162	T25	100	021623	7.11	V2169	T50	100	021692	7.11
V2163	T27	100	021630	7.11	V2170	T55	100	021708	7.11
V2165	T30	100	021654	7.11	V2171	T60	100	021715	7.11
V2167	T40	100	021678	7.11	V2172	T70	100	021722	7.87

TORX® screwdriver socket



VIGOR No.	Size	Length mm	EAN 4047728+	€
V2173	T40	140	021739	7.87
V2174	T45	140	021746	7.87
V2175	T50	140	021753	7.87
V2176	T55	140	021760	7.87
V2177	T60	140	021777	7.87
V2178	T70	140	021784	8.62

TORX® screwdriver socket



VIGOR No.	Size	Length mm	EAN 4047728+	€
V2179	T40	200	021791	8.62
V2180	T45	200	021807	8.62
V2181	T50	200	021814	8.62
V2182	T55	200	021821	8.62
V2183	T60	200	021838	8.62
V2184	T70	200	021845	9.59

TORX® screwdriver socket



VIGOR No.	Size	mm	EAN 4047728+	€
V2200	T55H	55	022002	6.36

RIBE screwdriver socket



VIGOR No.	Size	mm	EAN 4047728+	€
V2202	M5	55	022026	6.36
V2203	M6	55	022033	6.36
V2204	M7	55	022040	6.36
V2205	M8	55	022057	6.36
V2206	M9	55	022064	6.36

VIGOR No.	Size	mm	EAN 4047728+	€
V2207	M10	55	022071	6.36
V2208	M12	55	022088	6.36
V2209	M13	55	022095	7.11
V2210	M14	55	022101	7.11

RIBE screwdriver socket



VIGOR No.	Size	mm	EAN 4047728+	€
V2211	M5	100	022118	7.11
V2212	M6	100	022125	7.11
V2213	M7	100	022132	7.11
V2214	M8	100	022149	7.11
V2215	M9	100	022156	7.11

VIGOR No.	Size	mm	EAN 4047728+	€
V2216	M10	100	022163	7.11
V2217	M12	100	022170	7.11
V2218	M13	100	022187	7.87
V2219	M14	100	022194	7.87

RIBE screwdriver socket



VIGOR No.	Size	mm	EAN 4047728+	€
V2220	M8	140	022200	7.87
V2221	M9	140	022217	7.87
V2222	M10	140	022224	7.87
V2223	M10.3	140	022231	7.87
V2224	M12	140	022248	8.62
V2225	M13	140	022255	8.62
V2226	M14	140	022262	8.62

RIBE screwdriver socket



VIGOR No.	Size	mm	EAN 4047728+	€
V2227	M8	200	022279	8.62
V2228	M9	200	022286	8.62
V2229	M10	200	022293	8.62
V2230	M10.3	200	022309	8.62
V2231	M12	200	022316	8.62
V2232	M13	200	022323	9.59
V2233	M14	200	022330	9.59

Sockets



Universal joint

12⁵/₁₆ 12⁵/₁₆



VIGOR No.	mm	EAN 4047728+	€
V2575N	75	058407	9.49

Universal joint

12⁵/₁₆ 12⁵/₁₆



VIGOR No.	EAN 4047728+	€
V7202-3	069137	8.62

Extension

12⁵/₁₆ 12⁵/₁₆



VIGOR No.	mm	EAN 4047728+	€
V2576N	125	058414	6.04
V2577N	250	058421	10.03
V4398N	750	058896	32.77

Wobble extension

- Operating screw connections in confined spaces and working in areas with restricted access
- Spherical, tapered outside square

12⁵/₁₆ 12⁵/₁₆



VIGOR No.	mm	EAN 4047728+	€
V4317	50	043175	6.90
V4318	75	043182	7.22
V4319	250	043199	12.83

Extension

- Thanks to insert profile – Direct attachment to the nut/screw connection

12⁵/₁₆ 12⁵/₁₆



VIGOR No.	mm	EAN 4047728+	€
V7202-4	125	069144	10.67
V7202-5	250	069151	13.48



Adapter

10 3/8" 12⁵ 1/2"



VIGOR No.	mm	EAN 4047728+	€
V2109	36	021098	4.85

Adapter

20 3/4" 12⁵ 1/2"



VIGOR No.	mm	EAN 4047728+	€
V2110	46	021104	7.65

Bit adapter

8 5/16" 12⁵ 1/2"



VIGOR No.	mm	EAN 4047728+	€
V2647N	37	058711	3.45

Square adapter

12⁵ 1/2"



22 mm



VIGOR No.	EAN 4047728+	€
V7202-2	069120	12.40



Sockets



Impact wrench socket · short

- Surface: phosphatized
- For impact operation

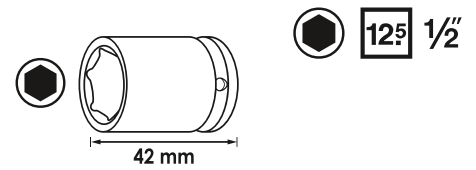

VIGOR No.	Size	EAN 4047728+	€
V5550S-10	10 mm	056175	4.53
V5550S-11	11 mm	056182	4.53
V5550S-12	12 mm	056199	4.53
V5550S-13	13 mm	056205	4.53
V5550S-14	14 mm	056212	4.53
V5550S-15	15 mm	056229	4.53
V5550S-16	16 mm	056236	4.53
V5550S-17	17 mm	056243	4.53
V5550S-18	18 mm	056250	4.64
V5550S-19	19 mm	056267	4.64
V5550S-21	21 mm	056274	5.17
V5550S-22	22 mm	056281	5.17
V5550S-24	24 mm	056298	5.50

Impact wrench socket · long

- Surface: phosphatized
- For impact operation

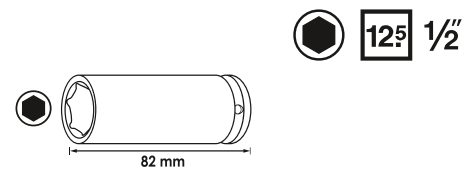

VIGOR No.	Size	EAN 4047728+	€
V5550L-10	10 mm	056045	6.68
V5550L-11	11 mm	056052	6.68
V5550L-12	12 mm	056069	6.68
V5550L-13	13 mm	056076	6.68
V5550L-14	14 mm	056083	6.68
V5550L-15	15 mm	056090	6.68
V5550L-16	16 mm	056106	7.01
V5550L-17	17 mm	056113	7.01
V5550L-18	18 mm	056120	7.01
V5550L-19	19 mm	056137	7.01
V5550L-21	21 mm	056144	7.55
V5550L-22	22 mm	056151	7.87
V5550L-24	24 mm	056168	8.95

Extractor socket with spiral profile

- Operation of nuts with damaged heads (special profile)



VIGOR No.	Size	mm	EAN 4047728+	€
V2405	10 mm	34	024051	15.52
V2402	11 mm	34	024020	15.52
V2406	12 mm	34	024068	15.52
V2407	13 mm	34	024075	15.52
V2401	14 mm	34	024013	15.52
V2408	15 mm	34	024082	15.52
V2403	16 mm	34	024037	15.52
V2409	17 mm	34	024099	15.52
V2410	19 mm	34	024105	15.52
V3742	21 mm	34	037426	17.25
V3743	22 mm	34	037433	18.33
V3744	24 mm	34	037440	19.51
V3745	27 mm	34	037457	22.96
V3746	30 mm	34	037464	26.41
V3747	32 mm	34	037471	29.11

Impact wrench socket (12-point) · short

- Extra thin-walled socket for cardan shaft screw connections in the wheel hub
- Borehole for locking pin or safety spring and groove for o-ring
- Adjusted to given spaces in the wheel hub
- For e.g.:
 - VW Touareg model year 2003 →
 - AUDI A4 model year 2001 → · A6 model year 2005 → · A8 model year 2003 → · Q7 model year 2007 →
 - Other models
- For impact operation

12⁵ 1/2

● 32 mm

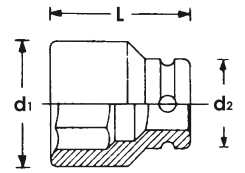

VIGOR No.	d1 mm	d2 mm	Size	L mm	EAN 4047728+	€
V4477	44.4	30	32 mm	50	044776	14.34

Impact wrench socket (12-point) · short

- Extra thin-walled socket for cardan shaft screw connections in the wheel hub
- Borehole for locking pin or safety spring and groove for o-ring
- Adjusted to given spaces in the wheel hub
- For e.g.: OPEL/VAUXHALL Corsa D model year 2006 →, Adam model year 2012 →, Mokka model year 2012 → · CHEVROLET/GMC Trax model year 2013 →
- Other models
- Also for BMW · SEAT and VW vehicles
- For impact operation

12⁵ 1/2

● 36 mm

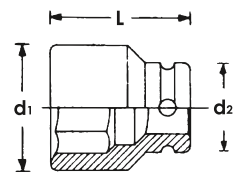

VIGOR No.	d1 mm	d2 mm	Size	L mm	EAN 4047728+	€
V4478	46.9	30	36 mm	50	044783	16.06

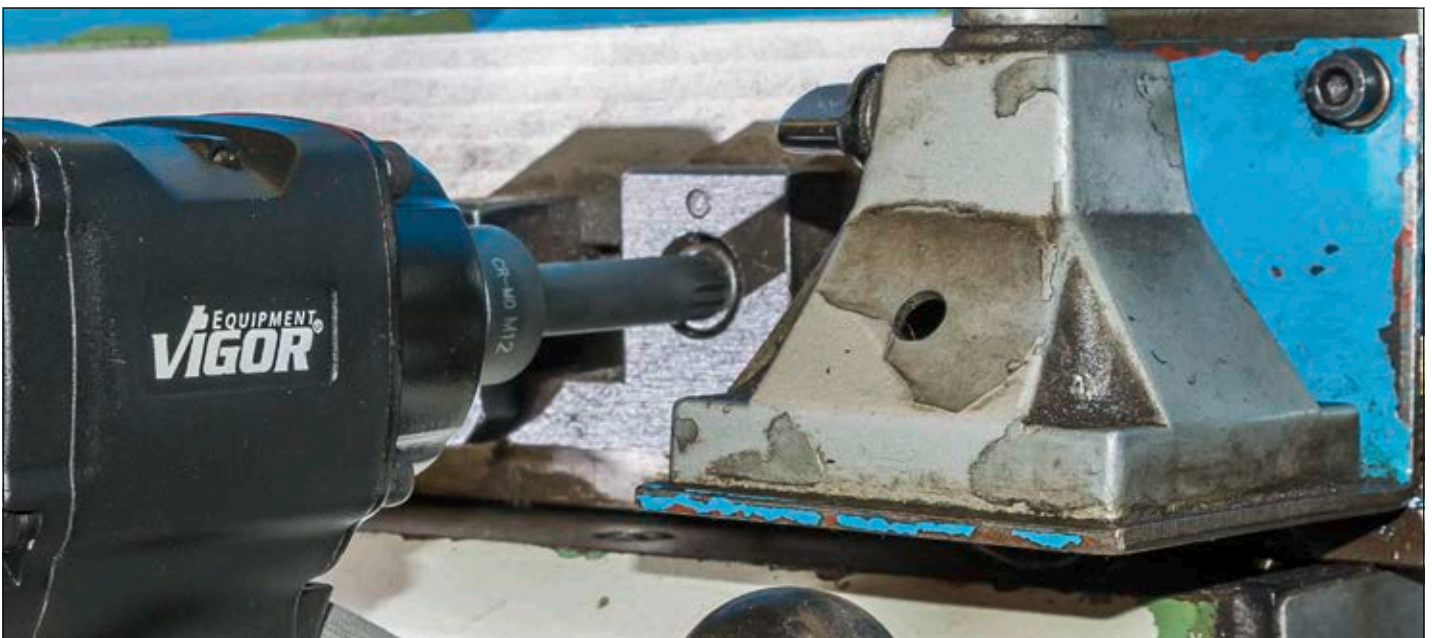

Sockets



Impact screwdriver socket

- Surface: phosphatized
- For impact operation



VIGOR No.	Size	Length mm	EAN 4047728+	€
V7017-T30	T30	78	066389	10.46
V7017-T40	T40	78	066396	10.46
V7017-T45	T45	78	066402	10.46
V7017-T50	T50	78	066419	10.46
V7017-T55	T55	78	066426	10.46
V7017-T60	T60	78	066242	10.46
V7017-T70	T70	78	066259	10.46
V7017-T80	T80	78	066266	11.43

Impact screwdriver socket

- Surface: phosphatized
- For impact operation



VIGOR No.	Size	Length mm	EAN 4047728+	€
V7018-M5	M5	78	066273	11.-
V7018-M6	M6	78	066280	11.-
V7018-M8	M8	78	066297	11.-
V7018-M10	M10	78	066303	11.-
V7018-M12	M12	78	066518	11.-
V7018-M14	M14	78	066525	11.-
V7018-M16	M16	78	066532	11.-
V7018-M18	M18	78	066549	12.29

Impact screwdriver socket

- Surface: phosphatized
- For impact operation



VIGOR No.	Size	Length mm	EAN 4047728+	€
V7019-H5	5 mm	78	066556	10.46
V7019-H6	6 mm	78	066563	10.46
V7019-H8	8 mm	78	066570	10.46
V7019-H10	10 mm	78	066587	10.46
V7019-H12	12 mm	78	066594	10.46
V7019-H14	14 mm	78	066600	10.46
V7019-H17	17 mm	78	066617	10.46
V7019-H19	19 mm	78	066624	10.46



V2318N, EAN 4047728**059299**

Socket set

- 24 teeth
- 15° Opening angle
- For manual operation

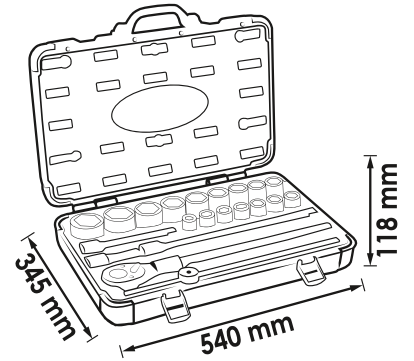
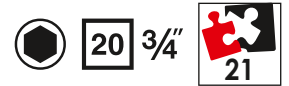

311.50 €
excl. VAT

Single parts from page 167

XX	■	●	Design	Size
16 x	20 3/4	●		19 · 21 · 22 · 23 · 24 · 26 · 27 · 28 · 30 · 32 · 34 · 36 · 38 · 41 · 46 · 50 mm
1 x	-	20 3/4		500 mm
1 x	20 3/4	20 3/4		100 mm
1 x	20 3/4	20 3/4		200 mm
1 x	20 3/4	20 3/4		400 mm
1 x	-	20 3/4		450 mm

Sockets



Reversible ratchet

- 24 teeth
- 15° Opening angle
- For manual operation

20 3/4"



VIGOR No.	mm	EAN 4047728+	€
V2319N	500	059282	110.-

Sliding T-handle

- For manual operation

20 3/4"



VIGOR No.	mm	EAN 4047728+	€
V2322N	450	057158	38.92

Socket

20 3/4"



VIGOR No.	Size	mm	EAN 4047728+	€
V2323N	19 mm	50	057165	11.-
V2324N	21 mm	50	057172	11.-
V2325N	22 mm	50	057189	11.-
V2326N	23 mm	50	057196	11.-
V2327N	24 mm	50	057202	11.-
V2328N	26 mm	50	057615	11.-
V2329N	27 mm	52	057622	12.94
V2256N	28 mm	52	057059	14.34
V2924N	30 mm	54	057639	21.45
V2331N	32 mm	56	057646	15.85
V2332N	34 mm	58	057653	18.87
V2333N	36 mm	58	057677	20.59
V2334N	38 mm	60	057684	20.59
V2337N	41 mm	64	057721	22.21
V2336N	46 mm	68	057707	23.39
V2335N	50 mm	68	057691	25.01



Extension



20 3/4" 20 3/4"

VIGOR No.	mm	EAN 4047728+	€
V2320N	100	057561	20.05
V2321N	200	057578	24.47
V2317N	400	057554	32.34

Adapter



12 5/8" 20 3/4"

VIGOR No.	mm	EAN 4047728+	€
V2111	50	021111	13.37

V5024, EAN 4047728050241

Impact socket set

- Extra thin-walled sockets for drive shaft screw joints in the wheel hub
- Adjusted to given spaces in the wheel hub
- Among others for:
 - Size 24: VW Touran model year 2006 →
 - Size 30: VW Passat C, Golf 4, Polo, New Beetle · AUDI TT · ŠKODA Octavia, Superb, Fabia
 - Size 32: VW Touareg model year 2003 →
 - SW 36: BMW 3-series · 5-series · 7-series · SEAT Ibiza · VW Polo, Golf Plus · OPEL Corsa D · Adam · Mokka · CHEVROLET Trax model year → 2013 · FIAT 500 · Grande Punto · Punto Evo model year → 2005 · FORD Ka · MERCEDES-BENZ S-Class · JAGUAR XJ40 · XJ181
- For impact operation

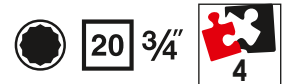

VIGOR No.	mm	d1 mm	d2 mm	Size	EAN 4047728+	€
V5025	44	44.3	35	24 mm	050258	26.52
V5026	50	44.3	42	30 mm	050265	27.49
V5182	50	44.3	44.3	32 mm	051828	28.78
V5183	50	44.3	46.9	36 mm	051835	31.15

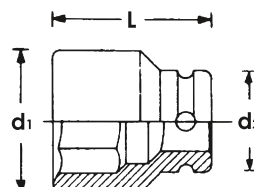

110.-€
excl. VAT

Sockets



V7212, EAN 4047728072120

Impact screwdriver socket set

- Common screw connections VAG vehicles, e.g. brake carriers, central drive shafts, shock absorbers or screwed wheel bearing units
- Surface: burnished, oiled
- For impact operation



VIGOR No.	L1 mm	mm	d2 mm	Size	EAN 4047728+	€
V7212-H14	30	60	44	14 mm	072168	29.11
V7212-H17	30	60	44	17 mm	072175	29.11
V7212-H19	30	60	44	19 mm	072182	29.11
V7212-H21	30	60	44	21 mm	072199	29.11
V7212-M14	30	60	44	M14	072137	29.11
V7212-M16	30	60	44	M16	072144	29.11
V7212-M18	30	60	44	M18	072151	29.11

106.50 €
excl. VAT

V3278, EAN 4047728032780

Socket set

- For manual operation



Single parts from page 171

XX	■		Design	Size
6 x	25 1"	●		50 · 55 · 60 · 65 · 70 · 80 mm
1 x	25 1"	25 1"		400 mm
1 x	-	25 1"		500 mm
1 x	-	25 1"		50 mm
1 x	-	25 1"		170 mm

480.- €
excl. VAT





Sockets



12-point socket

25 1"



VIGOR No.	Size	mm	EAN 4047728+	€
V3375N	50 mm	75	058803	44.31
V3376N	55 mm	80	058810	55.41
V3377N	60 mm	85	058827	55.41
V3378N	65 mm	87	058834	72.23
V3379N	70 mm	93	058841	76.65
V3380N	80 mm	103	058858	98.85

Sliding piece

25 1"



VIGOR No.	mm	EAN 4047728+	€
V3373N	50	058780	35.57

Sliding T-handle

25 1"



VIGOR No.	mm	EAN 4047728+	€
V3374N	500	058797	61.12

Extension

25 1" 25 1"



VIGOR No.	mm	EAN 4047728+	€
V3371N	400	058773	68.88



V5505, EAN 4047728**055055**

Impact universal joint set

- Working in areas with restricted access, and for getting around obstructive edges
- Borehole for locking pin or safety spring and groove for o-ring
- For impact operation

6.3 1/4 10 3/8 12⁵ 1/2 6.3 1/4 10 3/8 12⁵ 1/2



VIGOR No.	EAN 4047728+	€
V5505-1/4	055062	11.-
V5505-3/8	055079	12.72
V5505-1/2	055086	15.52

38.81 €
excl. VAT

V1293, EAN 4047728**012935**

Adapter set

- For manual operation

6.3 1/4 10 3/8 12⁵ 1/2 20 3/4
6.3 1/4 10 3/8 12⁵ 1/2 20 3/4

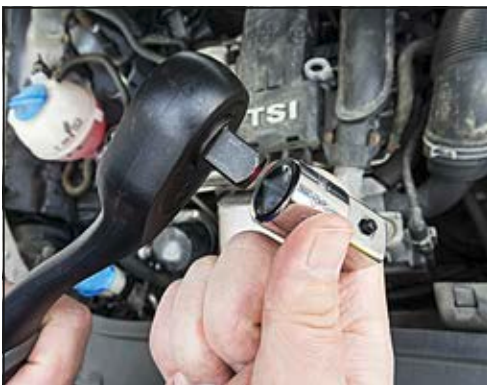

Single parts from page 132

	■	Design	Size
1 x	6.3 1/4	10 3/8	26 mm
1 x	10 3/8	6.3 1/4	27 mm
1 x	10 3/8	12 ⁵ 1/2	36 mm
1 x	12 ⁵ 1/2	10 3/8	36 mm
1 x	12 ⁵ 1/2	20 3/4	46 mm
1 x	20 3/4	12 ⁵ 1/2	50 mm

35.57 €
excl. VAT

Sockets



V6039, EAN 4047728**055857**

Fine-tooth reversible ratchet set

- Offset design
- Plastic coating
- Quick-release press-button
- Contents:
 - V6014 $6.3 \frac{1}{4}$ "
 - V6012 $12.5 \frac{1}{2}$ "
- DIN 3122, ISO 3315
- 72 teeth
- 5° Opening angle
- For manual operation

6.3 $\frac{1}{4}$ "

12.5 $\frac{1}{2}$ "



With quick-release press-button

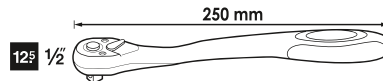
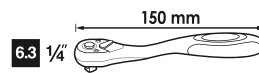

72.23 €
excl. VAT



V2687, EAN 4047728**026871**

TORX® socket set

• For manual operation



6.3 1/4"

10 3/8"

12.5 1/2"



Single parts from page 129

XX	■		Design	Size
7 x	6.3 1/4"			E4 · E5 · E6 · E7 · E8 · E10 · E11
12 x	10 3/8"			E4 · E5 · E6 · E7 · E8 · E10 · E11 · E12 · E14 · E16 · E18 · E20
9 x	12.5 1/2"			E10 · E11 · E12 · E14 · E16 · E18 · E20 · E22 · E24

74.49 €
excl. VAT

V1781, EAN 4047728**017817**

TORX® socket set

• For manual operation



6.3 1/4"

10 3/8"

12.5 1/2"



Single parts from page 129

XX	■		Design	Size
5 x	6.3 1/4"			E4 · E5 · E6 · E7 · E8
1 x	6.3 1/4"			T27
5 x	6.3 1/4"			T9H · T10H · T15H · T25H · T30H
4 x	10 3/8"			E10 · E12 · E14 · E16
4 x	10 3/8"			T40 · T45 · T47 · T50
2 x	10 3/8"			T45H · T50H
2 x	12.5 1/2"			E18 · E20
2 x	12.5 1/2"			T55 · T60
1 x	12.5 1/2"			T55H

66.84 €
excl. VAT

Sockets



V1706N, EAN 4047728056465

Socket set

• For manual operation

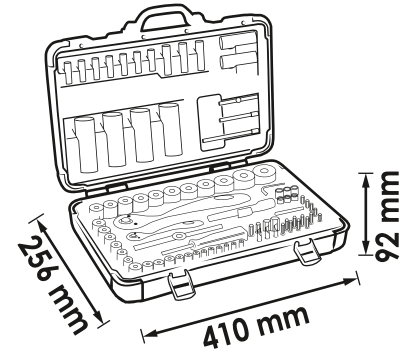

160.50 €
excl. VAT

Single parts from page 126

XX	■	□	Design	Size
4 x	8 5/16	☼		T40 · T45 · T50 · T55
4 x	8 5/16	○		8 · 10 · 12 · 14 mm
2 x	8 5/16	+		PH3 · PH4
2 x	8 5/16	✦		PZ3 · PZ4
3 x	8 5/16	◐		1.6x8 · 2x12 · 1.6x10 mm
3 x	-	○		1.5 · 2 · 2.5 mm
1 x	6.3 1/4	6.3 1/4		25 mm
1 x	12.5 1/2	8 5/16		37 mm
1 x	-	6.3 1/4		150 mm
1 x	6.3 1/4	6.3 1/4		110 mm
1 x	-	12.5 1/2		43.7 mm
4 x	6.3 1/4	○		3 · 4 · 5 · 6 mm
3 x	6.3 1/4	◐		0.8x4 · 1x5.5 · 1.2x7 mm
2 x	6.3 1/4	+		PH1 · PH2
2 x	6.3 1/4	✦		PZ1 · PZ2

XX	■	□	Design	Size
5 x	6.3 1/4	☼		T10 · T15 · T20 · T25 · T30
18 x	12.5 1/2	○		10 · 11 · 12 · 13 · 14 · 15 · 16 · 17 · 18 · 19 · 20 · 21 · 22 · 23 · 24 · 27 · 30 · 32 mm
4 x	12.5 1/2	○		14 · 15 · 17 · 19 mm
13 x	6.3 1/4	○		4 · 4.5 · 5 · 5.5 · 6 · 7 · 8 · 9 · 10 · 11 · 12 · 13 · 14 mm
8 x	6.3 1/4	○		6 · 7 · 8 · 9 · 10 · 11 · 12 · 13 mm
1 x	-	6.3 1/4		150 mm
1 x	-	12.5 1/2		250 mm
1 x	6.3 1/4	6.3 1/4		40 mm
1 x	12.5 1/2	12.5 1/2		75 mm
1 x	6.3 1/4	6.3 1/4		50 mm
1 x	6.3 1/4	6.3 1/4		100 mm
1 x	6.3 1/4	6.3 1/4		145 mm
1 x	12.5 1/2	12.5 1/2		125 mm
1 x	12.5 1/2	12.5 1/2		250 mm
2 x	12.5 1/2	○		16 · 21 mm



V2461N, EAN 4047728056472

Socket set

• For manual operation

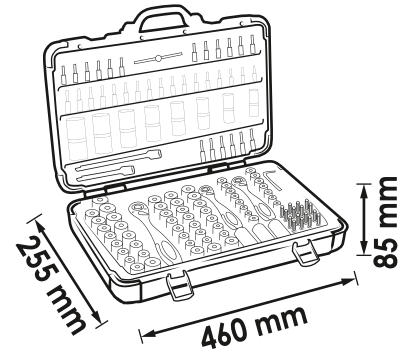
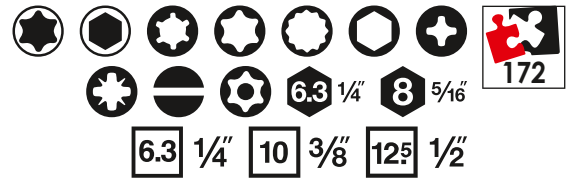

172.50 €
excl. VAT

Single parts from page 126

XX	■	Design	Size
5 x	6.3 1/4	R5 · R6 · R7 · R8 · R9	
3 x	6.3 1/4	T5 · T6 · T7	
3 x	6.3 1/4	M5 · M6 · M8	
9 x	6.3 1/4	T7H · T10H · T15H · T20H · T25H · T27H · T30H · T40H · T45H	
6 x	8 5/16	T40 · T45 · T50 · T55 · T60 · T70	
5 x	8 5/16	7 · 8 · 10 · 12 · 14 mm	
2 x	8 5/16	PH3 · PH4	
2 x	8 5/16	PZ3 · PZ4	
3 x	8 5/16	1.6x8 · 1.6x10 · 2x12 mm	
6 x	8 5/16	T40H · T45H · T50H · T55H · T60H · T70H	
4 x	-	1.3 · 1.5 · 2 · 2.5 mm	
1 x	6.3 1/4	6.3 1/4	25 mm
1 x	10 3/8	8 5/16	28 mm
1 x	12.5 1/2	8 5/16	37 mm
1 x	-	6.3 1/4	150 mm
1 x	6.3 1/4	6.3 1/4	110 mm
1 x	-	12.5 1/2	43.7 mm
4 x	6.3 1/4	3 · 4 · 5 · 6 mm	
4 x	6.3 1/4	0.8x4 · 1x5.5 · 1.2x6.5 · 1.2x7 mm	
3 x	6.3 1/4	PH0 · PH1 · PH2	
3 x	6.3 1/4	PZ0 · PZ1 · PZ2	
7 x	6.3 1/4	T9 · T10 · T15 · T20 · T25 · T27 · T30	
6 x	6.3 1/4	T9H · T10H · T15H · T25H · T27H · T30H	

XX	■	Design	Size
6 x	10 3/8	E10 · E11 · E12 · E14 · E16 · E18	
6 x	10 3/8	10 · 11 · 12 · 13 · 14 · 15 mm	
10 x	10 3/8	10 · 11 · 12 · 13 · 14 · 15 · 16 · 17 · 18 · 19 mm	
17 x	12.5 1/2	10 · 11 · 12 · 13 · 14 · 15 · 16 · 17 · 18 · 19 · 20 · 21 · 22 · 24 · 27 · 30 · 32 mm	
5 x	12.5 1/2	16 · 17 · 18 · 19 · 22 mm	
2 x	12.5 1/2	E20 · E22	
13 x	6.3 1/4	4 · 4.5 · 5 · 5.5 · 6 · 7 · 8 · 9 · 10 · 11 · 12 · 13 · 14 mm	
7 x	6.3 1/4	4 · 5 · 6 · 7 · 8 · 9 · 10 mm	
5 x	6.3 1/4	E4 · E5 · E6 · E7 · E8	
1 x	-	6.3 1/4	150 mm
1 x	-	10 3/8	198 mm
1 x	-	12.5 1/2	250 mm
1 x	6.3 1/4	6.3 1/4	40 mm
1 x	10 3/8	10 3/8	50 mm
1 x	12.5 1/2	12.5 1/2	75 mm
1 x	6.3 1/4	6.3 1/4	50 mm
1 x	6.3 1/4	6.3 1/4	100 mm
1 x	10 3/8	10 3/8	125 mm
1 x	12.5 1/2	12.5 1/2	125 mm
1 x	12.5 1/2	12.5 1/2	250 mm
1 x	10 3/8		18 mm
2 x	12.5 1/2		16 · 21 mm

Sockets



V3277N, EAN 4047728056489

Socket set

• For manual operation

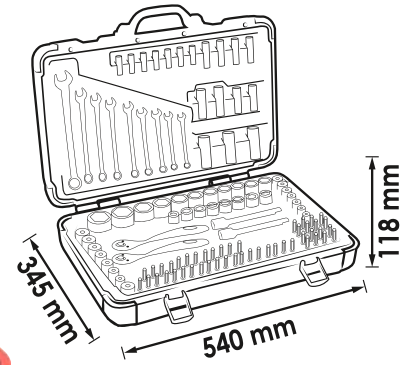
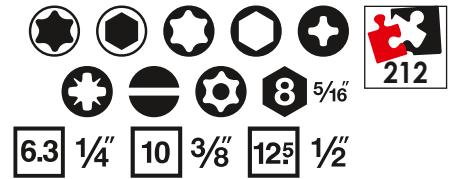

275.-€
excl. VAT

Single parts from page 126

XX	■	⊕	Design	Size
3 x	6.3 1/4	⊕		PH1 · PH2 · PH3
3 x	6.3 1/4	⊕		PZ1 · PZ2 · PZ3
3 x	6.3 1/4	⊖		1 x 5.5 · 1 x 6 · 1.6 x 8 mm
5 x	6.3 1/4	○		3 · 4 · 5 · 6 · 7 mm
6 x	6.3 1/4	⊕		T15H · T20H · T25H · T27H · T30H · T40H
10 x	6.3 1/4	⊕		T10 · T15 · T20 · T25 · T27 · T30 · T40 · T45 · T8 · T9
4 x	8 5/16	○		7 · 8 · 10 · 12 mm
3 x	8 5/16	⊖		1.6 x 8 · 1.6 x 10 · 2 x 12 mm
3 x	8 5/16	⊕		PH2 · PH3 · PH4
3 x	8 5/16	⊕		PZ2 · PZ3 · PZ4
5 x	8 5/16	⊕		T40 · T45 · T50 · T55 · T60
5 x	8 5/16	⊕		T40H · T45H · T50H · T55H · T60H
4 x	8 5/16	⊕		R10 · R11 · R12 · R13
2 x	8 5/16	○		M10 · M12
1 x	-	6.3 1/4		200 mm
4 x	-	○		1.3 · 1.5 · 2 · 2.5 mm
12 x	-	●●		8 · 9 · 10 · 11 · 12 · 13 · 14 · 15 · 17 · 19 · 22 · 24 mm
1 x	10 3/8	8 5/16		28 mm
1 x	12.5 1/2	8 5/16		37 mm
1 x	6.3 1/4	6.3 1/4		25 mm
1 x	-	6.3 1/4		150 mm
10 x	10 3/8	●		11 · 10 · 12 · 13 · 14 · 15 · 16 · 17 · 18 · 19 mm

XX	■	⊕	Design	Size
6 x	10 3/8	⊕		E18 · E16 · E14 · E12 · E11 · E10
6 x	10 3/8	○		10 · 11 · 12 · 13 · 14 · 15 mm
14 x	12.5 1/2	○		13 · 14 · 15 · 16 · 17 · 18 · 19 · 20 · 21 · 22 · 24 · 27 · 30 · 32 mm
3 x	12.5 1/2	⊕		E24 · E22 · E20
5 x	12.5 1/2	○		16 · 17 · 18 · 19 · 22 mm
13 x	6.3 1/4	○		4 · 4.5 · 5 · 5.5 · 6 · 7 · 8 · 9 · 10 · 11 · 12 · 13 · 14 mm
5 x	6.3 1/4	⊕		E8 · E7 · E6 · E5 · E4
7 x	6.3 1/4	○		4 · 5 · 6 · 7 · 8 · 9 · 10 mm
1 x	-	6.3 1/4		150 mm
1 x	-	10 3/8		198 mm
1 x	-	12.5 1/2		250 mm
1 x	12.5 1/2	12.5 1/2		75 mm
1 x	10 3/8	10 3/8		50 mm
1 x	6.3 1/4	6.3 1/4		40 mm
1 x	12.5 1/2	12.5 1/2		125 mm
1 x	10 3/8	10 3/8		125 mm
1 x	6.3 1/4	6.3 1/4		100 mm
1 x	6.3 1/4	6.3 1/4		50 mm
1 x	12.5 1/2	12.5 1/2		250 mm
2 x	12.5 1/2	○		21 · 16 mm
1 x	10 3/8	○		18 mm

V4425N, EAN 4047728058919

Tool case · universal



290.- €
excl. VAT

Single parts from page 126

XX	■	●	Design	Size
12 x	-	●●		8 · 9 · 10 · 11 · 12 · 13 · 14 · 15 · 16 · 17 · 18 · 19 mm
4 x	-	●		0.6x3 · 0.8x4 · 1x5.5 · 1.2x6.5 mm
3 x	-	⊕		PH0 · PH1 · PH2
1 x	-	-		90 mm
1 x	-	-		160 mm
1 x	-	-		200 mm
1 x	-	-		300 g
1 x	6.3 1/4	6.3 1/4		100 mm
1 x	6.3 1/4	6.3 1/4		40 mm
11 x	6.3 1/4	●		4 · 5 · 5.5 · 6 · 7 · 8 · 9 · 10 · 11 · 12 · 13 mm
1 x	-	-	-	-
1 x	125 1/2	125 1/2		125 mm

XX	■	●	Design	Size
1 x	125 1/2	125 1/2		75 mm
16 x	125 1/2	●		10 · 11 · 12 · 13 · 14 · 15 · 16 · 17 · 19 · 20 · 21 · 22 · 24 · 27 · 30 · 32 mm
4 x	6.3 1/4	●		3 · 4 · 5 · 6 mm
3 x	6.3 1/4	●		0.8x4 · 1x5.5 · 1.2x6.5 mm
3 x	6.3 1/4	⊕		PH1 · PH2 · PH3
3 x	6.3 1/4	⊕		PZ1 · PZ2 · PZ3
6 x	6.3 1/4	●		T10 · T15 · T20 · T25 · T30 · T40
1 x	-	6.3 1/4		150 mm
1 x	-	125 1/2		250 mm
9 x	-	●		1.5 · 2 · 2.5 · 3 · 4 · 5 · 6 · 8 · 10
9 x	-	●		T10 · T15 · T20 · T25 · T27 · T30 · T40 · T45 · T50

Universal tool cases



V2542, EAN 4047728**025423**

Tool case · universal

• Tool case including assortment



VIGOR No.	Designation	EAN 4047728+	€
V2400	Case · empty	024006	72.-
V2464	Soft foam insert · empty	024648	38.81

430.- €
excl. VAT



Double open-end wrench

- Secure hold with oily hands thanks to anti-slip surface
- Surface: matt chrome-plated
- DIN 3110

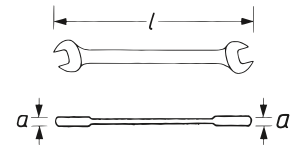

VIGOR No.	a mm	Size	L mm	EAN 4047728+	€
V1461N-6X7	3.4	6x7 mm	126	064903	2.05
V1461N-8X9	3.6	8x9 mm	142	064187	2.05
V1461N-10X11	4.5	10x11 mm	157	064200	2.48
V1461N-12X13	5.1	12x13 mm	170	064231	2.70
V1461N-14X15	5.4	14x15 mm	187	064262	2.91
V1461N-16X17	6	16x17 mm	202	064286	3.23

VIGOR No.	a mm	Size	L mm	EAN 4047728+	€
V1461N-18X19	7.3	18x19 mm	220	064309	3.99
V1461N-20X22	7.3	20x22 mm	232	064026	4.96
V1461N-21X23	7.5	21x23 mm	246	064033	5.39
V1461N-24X27	8.4	24x27 mm	265	064064	6.90
V1461N-25X28	8.5	25x28 mm	275	064071	8.41
V1461N-30X32	9.2	30x32 mm	298	064095	9.92

V1461N, EAN 4047728064934

Double open-end wrench set

- Secure hold with oily hands thanks to anti-slip surface
- Surface: matt chrome-plated
- DIN 3110



xx	Design	Size
12 x		6x7 · 8x9 · 10x11 · 12x13 · 14x15 · 16x17 · 18x19 · 20x22 · 21x23 · 24x27 · 25x28 · 30x32 mm

63.60 € excl. VAT

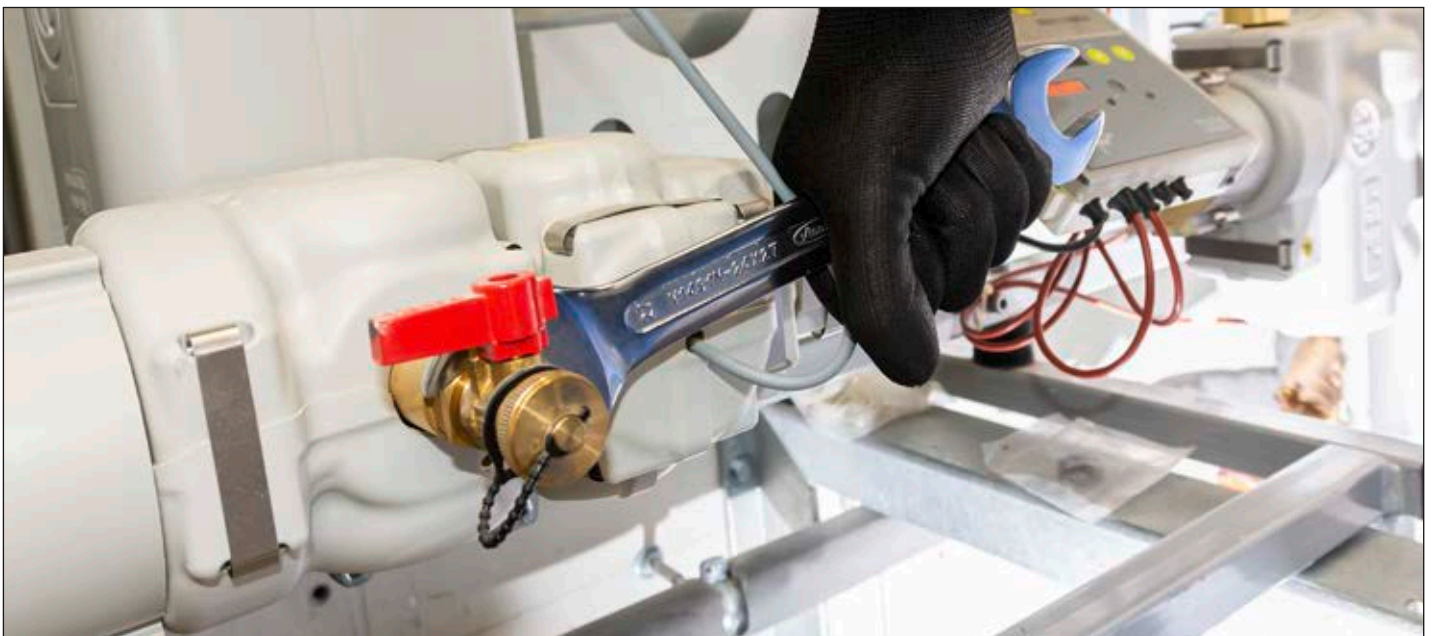

Wrenches



Combination wrench

- Long design
- 15° offset box-end wrench
- Secure hold with oily hands thanks to anti-slip surface
- Surface: matt chrome-plated
- DIN 3113 form A, ISO 7738

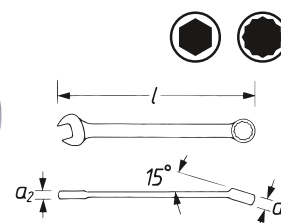

VIGOR No.	a1 mm	a2 mm	Size	L mm	EAN 4047728+	€
V4473N-6	4.8	3.4	6 mm	100	064439	2.59
V4473N-7	5.4	3.5	7 mm	110	064446	2.70
V4473N-8	5.5	3.8	8 mm	115	064453	2.80
V4473N-9	6	4	9 mm	125	064460	2.91
V4473N-10	6.3	4.5	10 mm	135	064477	3.02
V4473N-11	6.8	4.9	11 mm	145	064484	3.13
V4473N-12	7.2	5	12 mm	155	064491	3.45
V4473N-13	8.3	5.6	13 mm	185	064507	3.67
V4473N-14	8.5	5.7	14 mm	171	064514	4.10
V4473N-15	9.2	6.1	15 mm	185	064323	4.42
V4473N-16	9.3	6.5	16 mm	195	064569	5.28

VIGOR No.	a1 mm	a2 mm	Size	L mm	EAN 4047728+	€
V4473N-17	9.6	6.8	17 mm	210	064576	5.39
V4473N-18	10.1	7.2	18 mm	220	064583	5.93
V4473N-19	10.2	7.3	19 mm	230	064590	6.36
V4473N-20	10.8	7.4	20 mm	240	064606	6.47
V4473N-21	11.1	7.6	21 mm	245	064613	6.90
V4473N-22	11.7	7.9	22 mm	248	064408	7.76
V4473N-24	12.8	8.4	24 mm	270	064712	9.92
V4473N-27	13.9	9.1	27 mm	300	064736	13.15
V4473N-30	15.2	9.9	30 mm	330	064743	14.77
V4473N-32	15.9	10.2	32 mm	350	064750	17.46
V4473N-36	19.3	11.6	36 mm	400	064767	21.56

V4472N, EAN 4047728064958

Combination wrench set

- Long design
- 15° offset box-end wrench
- Secure hold with oily hands thanks to anti-slip surface
- Surface: matt chrome-plated
- DIN 3113 form A, ISO 7738



Design	Size
15 x	6 · 7 · 8 · 9 · 10 · 11 · 12 · 13 · 14 · 15 · 16 · 17 · 18 · 19 · 22 mm

59.29 € excl. VAT

V4473N, EAN 4047728064965

Combination wrench set

- Long design
- 15° offset box-end wrench
- Secure hold with oily hands thanks to anti-slip surface
- Surface: matt chrome-plated
- DIN 3113 form A, ISO 7738



Design	Size
22 x	6 · 7 · 8 · 9 · 10 · 11 · 12 · 13 · 14 · 15 · 16 · 17 · 18 · 19 · 20 · 21 · 22 · 24 · 27 · 30 · 32 · 36 mm

106.50 € excl. VAT



Double box-end wrench

- 15° offset
- Secure hold with oily hands thanks to anti-slip surface
- Surface: chrome-plated, polished
- DIN 838, ISO 10104

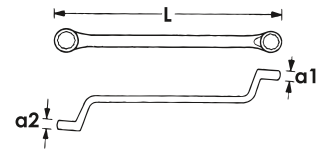

VIGOR No.	a1 mm	a2 mm	Size	L mm	EAN 4047728+	€
V1524N-6X7	5.8	5	6 x 7 mm	175	064774	2.80
V1524N-8X9	7.7	6.7	8 x 9 mm	185	064781	3.45
V1524N-10X11	8.4	7.4	10 x 11 mm	198	064798	3.88
V1524N-12X13	8.4	9.1	12 x 13 mm	215	064804	4.74
V1524N-14X15	10.4	9.5	14 x 15 mm	228	064811	5.28
V1524N-16X17	10.8	10	16 x 17 mm	246	064828	5.82
V1524N-18X19	12.1	10.8	18 x 19 mm	268	064835	6.36
V1524N-20X22	12.5	11.7	20 x 22 mm	292	064842	7.01
V1524N-21X23	13.2	12.2	21 x 23 mm	315	064859	8.73
V1524N-24X27	13.4	12.2	24 x 27 mm	328	064866	10.03
V1524N-25X28	14.9	13.9	25 x 28 mm	342	064873	13.48
V1524N-30X32	16	15.2	30 x 32 mm	370	064880	14.12

V1524N, EAN 4047728064910

Double box-end wrench set

- 15° offset
- Secure hold with oily hands thanks to anti-slip surface
- Surface: chrome-plated, polished
- DIN 838, ISO 10104



XX	Design	Size
12 x		6 x 7 · 8 x 9 · 10 x 11 · 12 x 13 · 14 x 15 · 16 x 17 · 18 x 19 · 20 x 22 · 21 x 23 · 24 x 27 · 25 x 28 · 30 x 32 mm

74.38 €
excl. VAT

Wrenches



V4951, EAN 4047728**049511**

Ratcheting open-end wrench set

- Ratchet function on the jaw end of the wrench:
 - Operation of screw connections without having to reposition the tool
 - Working even in areas with restricted access
- Simplified mechanics to minimise flaws
- Including tool roll
- Surface: chrome-plated, polished



xx	Design	Size
5 x		8 · 10 · 13 · 17 · 19 mm

39.90 €
excl. VAT



Ratcheting combination wrench · short

- 72 teeth
- 5° Opening angle

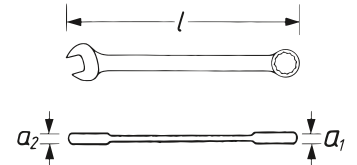

VIGOR No.	a1 mm	a2 mm	Size	l mm	EAN 4047728+	€
V2822	7.4	4.9	8 mm	89	028226	13.15
V2823	7.5	5.2	9 mm	93	028233	13.15
V2824	8.5	5.5	10 mm	97	028240	13.69
V2825	8.4	6.1	11 mm	102	028257	13.69
V2826	8.5	6.3	12 mm	106	028264	14.23
V2827	8.4	6.7	13 mm	110	028271	14.23
V2828	8.4	7	14 mm	114	028288	15.20
V2829	8.4	7.4	15 mm	120	028295	16.49
V2830	10	7.7	16 mm	122	028301	16.49
V2831	10	7.7	17 mm	126	028318	18.65
V2832	11.5	8.4	18 mm	131	028325	19.73
V2833	11.5	8.6	19 mm	136	028332	20.27

V2821, EAN 4047728028219

Ratcheting combination wrench set · short

- Delivery in tool roll
- 72 teeth
- 5° Opening angle



xx	Design	Size
12 x		8 · 9 · 10 · 11 · 12 · 13 · 14 · 15 · 16 · 17 · 18 · 19 mm

165.50 €
excl. VAT

Wrenches



Ratcheting combination wrench · long

- Surface: chrome-plated, polished
- 72 teeth
- 5° Opening angle

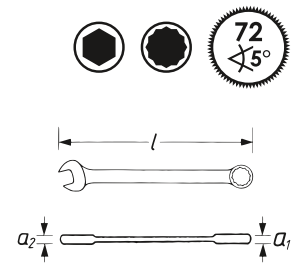

VIGOR No.	a1 mm	a mm	Size	L mm	EAN 4047728+	€
V3635	7.4	4.6	6 mm	135	036351	12.40
V3636	7.4	4.7	7 mm	144	036368	12.40
V1008	7.4	4.7	8 mm	140	010085	13.15
V1009	7.4	5.3	9 mm	151	010092	13.15
V1010	8.4	5.7	10 mm	160	010108	14.23
V1021	8.4	6.1	11 mm	165	010214	14.23
V1022	8.4	6.4	12 mm	170	010221	14.77
V1023	8.4	6.6	13 mm	177	010238	15.20
V1025	8.4	7.3	14 mm	192	010252	15.95
V1026	8.4	7.5	15 mm	200	010269	16.28

VIGOR No.	a1 mm	a mm	Size	L mm	EAN 4047728+	€
V1027	10	7.7	16 mm	210	010276	18.43
V1028	10	7.9	17 mm	225	010283	18.43
V1029	11.5	8.4	18 mm	235	010290	19.73
V1030	11.5	8.7	19 mm	245	010306	20.70
V4961	12.5	9	21 mm	275	049610	30.18
V4962	13.5	10	22 mm	285	049627	33.42
V4963	13.5	11	24 mm	296	049634	37.73
V4964	13.5	12	27 mm	340	049641	51.64
V4965	16	13	30 mm	369	049658	76.86
V4966	16	14	32 mm	395	049665	87.10

V1031, EAN 4047728010313

Ratcheting combination wrench set · long

- Tool roll
- Surface: chrome-plated, polished
- 72 teeth
- 5° Opening angle



xx	Design	Size
12 x		8 · 9 · 10 · 11 · 12 · 13 · 14 · 15 · 16 · 17 · 18 · 19 mm

178.- €
excl. VAT

V2820, EAN 4047728028202

Ratcheting combination wrench set · long

- Tool roll
- Surface: chrome-plated, polished
- 72 teeth
- 5° Opening angle



xx	Design	Size
5 x		8 · 10 · 13 · 17 · 19 mm

79.99 €
excl. VAT



Double joint ratcheting combination wrench

- Ratchet head with double joint
- 12-point profile in ring
- 72 teeth
- 5° Opening angle

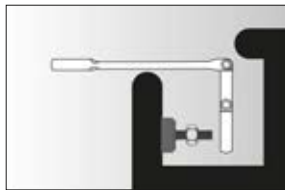
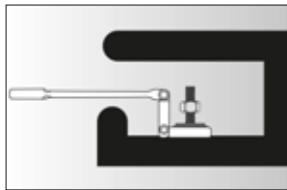
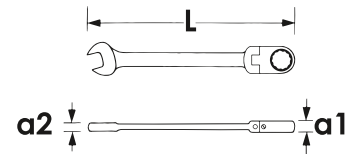
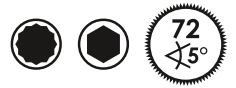

VIGOR No.	a1 mm	a2 mm	Size	L mm	EAN 4047728+	€
V6752-8	7.4	4.7	8 mm	163	067522	29.11
V6752-9	7.4	5.3	9 mm	168	067836	29.11
V6752-10	8.4	5.7	10 mm	178	067843	29.65
V6752-11	8.4	6.1	11 mm	186	067850	30.18
V6752-12	8.4	6.4	12 mm	196	067867	31.80
V6752-13	8.4	6.6	13 mm	206	067874	32.23
V6752-14	8.4	7.3	14 mm	217	067881	35.04
V6752-15	8.4	7.5	15 mm	228	067898	36.65
V6752-16	10	7.7	16 mm	245	067904	38.81
V6752-17	10	7.9	17 mm	259	068017	40.96
V6752-18	11.5	8.4	18 mm	273	068024	44.74
V6752-19	11.5	8.7	19 mm	285	068031	46.35

V6752/12, EAN 4047728068048

Double joint ratcheting combination wrench set

- Ratchet head with double joint
- 12-point profile in ring
- In tool roll
- 72 teeth
- 5° Opening angle



xx	Design	Size
12 x		8 · 9 · 10 · 11 · 12 · 13 · 14 · 15 · 16 · 17 · 18 · 19 mm

431.-€
excl. VAT

Wrenches



Ratcheting combination wrench with hinge

- 72 teeth
- 5° Opening angle

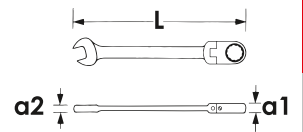

VIGOR No.	a1 mm	a2 mm	Size	L mm	EAN 4047728+	€
V2804	7.4	5	8 mm	143	028042	15.52
V2805	7.4	5.3	9 mm	150	028059	16.06
V2806	8.4	5.9	10 mm	158	028066	16.49
V2807	8.4	6.1	11 mm	165	028073	16.82
V2808	8.4	6.4	12 mm	170	028080	17.46
V2809	8.4	6.7	13 mm	182	028097	20.37
V2810	8.4	7.4	14 mm	190	028103	20.48
V2811	8.5	7.6	15 mm	200	028110	21.24
V2812	9.9	7.6	16 mm	215	028127	22.42
V2813	10	8	17 mm	228	028134	24.58
V2814	11.1	8.2	18 mm	241	028141	24.79
V2817	11.5	8.7	19 mm	250	028172	25.55



V6752/5, EAN 4047728072113

Double joint ratcheting combination wrench set

- Ratchet head with double joint
- 12-point profile in ring
- 72 teeth
- 5° Opening angle



Design	Size
5 x	8 · 10 · 13 · 17 · 19 mm

143.50 €
excl. VAT

V2818, EAN 4047728028189

Ratcheting combination wrench set with hinge

- Tool roll
- Surface: chrome-plated, polished
- 72 teeth
- 5° Opening angle



Design	Size
12 x	8 · 9 · 10 · 11 · 12 · 13 · 14 · 15 · 16 · 17 · 18 · 19 mm

221.- €
excl. VAT



V3607, EAN 4047728**036078**

Double ratcheting box-end wrench

- 72 teeth
- 5° Opening angle



Multi-purpose profile



VIGOR No.	a1 mm	a2 mm	Size	mm	EAN 4047728+	€
V3607	12.5	14.5	8x12 · 10x13	220	036078	24.47

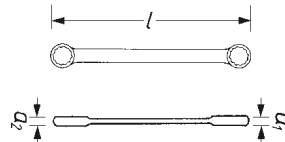

V2705, EAN 4047728**027052**

Double ratcheting box-end wrench

- 72 teeth
- 5° Opening angle



12-point

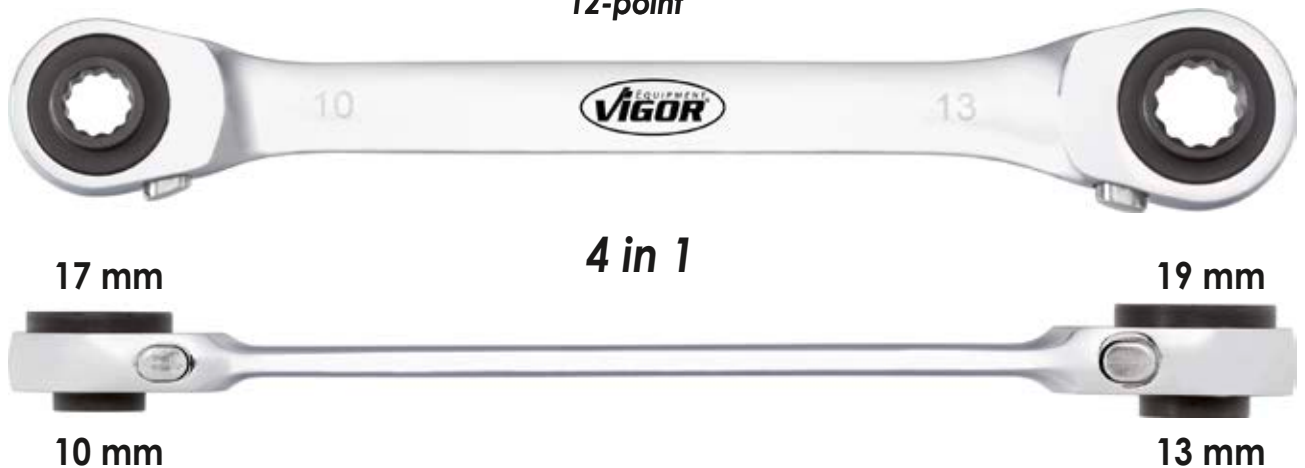

VIGOR No.	a1 mm	a2 mm	Size	mm	EAN 4047728+	€
V2705	20	17	10x13 · 17x19	220	027052	33.20

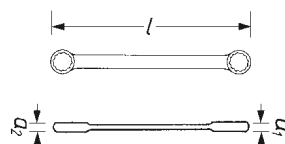

Double ratcheting box-end wrench

- Surface: bright chrome-plated
- 72 teeth
- 5° Opening angle



NEW



VIGOR No.	Size	EAN 4047728+	€
V6611-6X8	E6, E8	073578	17.50
V6611-10X12	E10, E12	073585	17.50
V6611-14X18	E14, E18	073592	17.50
V6611-20X24	E20, E24	073608	17.50

V6611/4, EAN 4047728073561

Double ratcheting box-end wrench set

- Tool roll
- Surface: bright chrome-plated
- 72 teeth
- 5° Opening angle



NEW



XX	Design	Size
1 x		E6, E8
1 x		E10, E12
1 x		E14, E18
1 x		E20, E24

86.02 €
excl. VAT



Adjustable wrench

- One-hand wrench size adjustment using the adjustable wheel on the wrench head
- Head set angled at 15°
- Easily legible mm scale on the wrench head



mm scale on the wrench head



Hanging hole

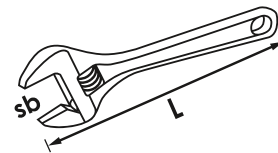

VIGOR No.	L mm	sb mm	EAN 4047728+	€
V6048	150	24	069625	17.14
V6049	250	33	069618	28.24



Screwdrivers and bits



V4655, EAN 4047728**046558**

Screwdriver set

• Manufactured according to DIN/ISO



XX		Design	Size
1 x	⊖		1 x 5.5 mm
5 x	⊖		0.6 x 3 · 0.8 x 4 · 1 x 5.5 · 1.6 x 8 · 1.6 x 10 mm
1 x	⊕		PH2
4 x	⊕		PH0 · PH1 · PH2 · PH3

46.46 €
excl. VAT

V1637, EAN 4047728**016377**

Screwdriver set

• Manufactured according to DIN/ISO



XX		Design	Size
4 x	⊖		0.6 x 3 · 0.8 x 4 · 1 x 5.5 · 1.2 x 6.5 mm
3 x	⊕		PH0 · PH1 · PH2

22.75 €
excl. VAT

V1208, EAN 4047728**012089**

Screwdriver · short

• ⊖ 5.5 x 38 mm



5.07 €
excl. VAT

V1209, EAN 4047728**012096**

Screwdriver · short

• ⊕ PH 2 x 38 mm



5.07 €
excl. VAT

Screwdriver for slotted screws

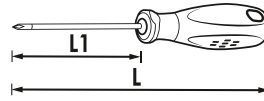

VIGOR No.	Size	L1 mm	L mm	EAN 4047728+	€
V1698	0.6x3 mm	75	156	016988	3.34
V1699	0.8x4 mm	80	161	016995	3.34
V1700	1x5.5 mm	125	231	017008	4.20
V1701	1.2x6.5 mm	150	256	017015	4.42
V3613	1.6x8 mm	150	266	036139	5.28
V3609	1.6x10 mm	175	291	036092	5.39

Phillips-Recess screwdriver

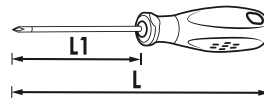

VIGOR No.	Size	L1 mm	L mm	EAN 4047728+	€
V1702	PH0	75	156	017022	3.34
V1703	PH1	80	186	017039	3.34
V1704	PH2	100	206	017046	4.42
V3610	PH3	150	266	036108	5.39

Screwdriver with impact cap

• Manufactured according to DIN/ISO



With impact cap

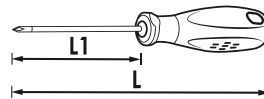

VIGOR No.	Size	L1 mm	L mm	EAN 4047728+	€
V3597	0.6x3.5 mm	75	157	035972	5.17
V3598	1x4.5 mm	100	182	035989	5.17
V3599	1x5.5 mm	100	207	035996	5.71
V3600	1.2x6.5 mm	125	232	036009	6.68
V5042	1.6x8 mm	150	267	050425	7.55
V5043	1.6x10 mm	175	297	050432	8.84
V5044	2x12 mm	200	317	050449	10.03

Phillips-recess screwdriver with impact cap

• Manufactured according to DIN/ISO



With impact cap

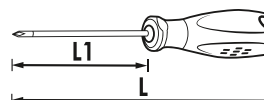

VIGOR No.	Size	L1 mm	L mm	EAN 4047728+	€
V3601	PH1	182	75	036016	5.17
V3602	PH2	207	100	036023	5.71
V4667	PH3	200	315	046671	9.27

Screwdrivers and bits



V3562, EAN 4047728035620
Screwdriver set with impact cap
 • Manufactured according to DIN/ISO



With impact cap

6-point



33.09 €
excl. VAT

XX	Design	Size
4 x		0.6 x 3.5 · 1 x 4.5 · 1 x 5.5 · 1.2 x 6.5 mm
2 x		PH1 · PH2

V4432/6, EAN 4047728073868
Screwdriver set · extra long
 • Working in areas with restricted access



NEW



710 mm total length
600 mm blade length

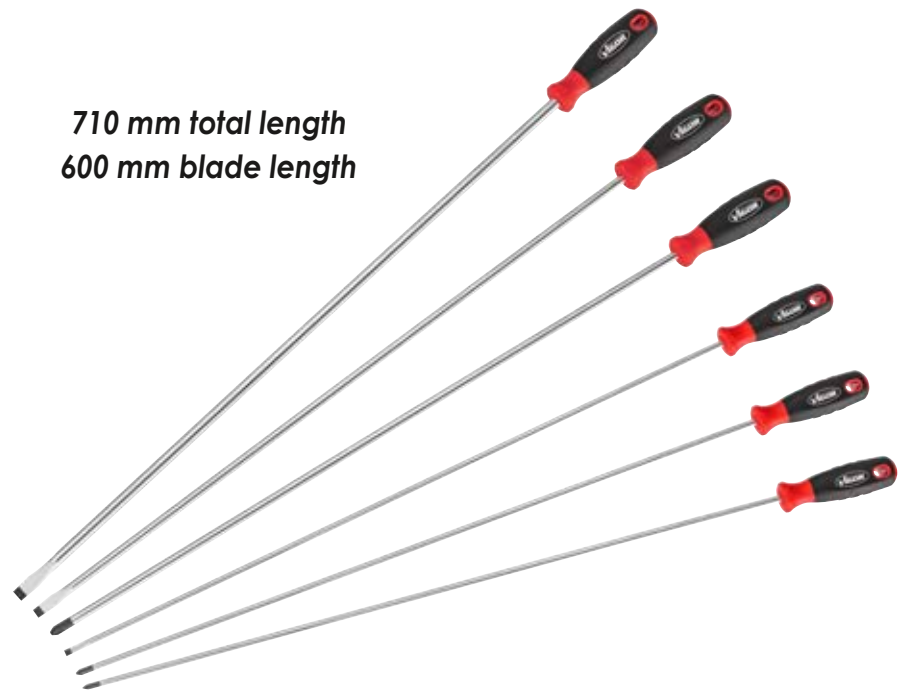

VIGOR No.	Designation	Design	Tip	Size	mm	EAN 4047728+	€
V4436	Screwdriver for slotted screws · extra long			1.2 x 6 mm	600	073905	11.38
V4437	Screwdriver for slotted screws · extra long			1.6 x 8 mm	600	073912	12.81
V4438	Screwdriver for slotted screws · extra long			1.6 x 10 mm	600	073929	14.23
V4433	Phillips-Recess screwdriver · extra long			PH1	600	073875	10.67
V4434	Phillips-Recess screwdriver · extra long			PH2	600	073882	11.38
V4435	Phillips-Recess screwdriver · extra long			PH3	600	073899	12.10

70.93 €
excl. VAT



V7124, EAN 4047728071246

Impact screwdriver set

- Operation of severely corroded screw connections, e.g. centring screws on brake discs
- A hammer strike actuates a quarter turn in release direction at the screwdriver output
- Switching modes by turning the control dial in 2 steps: standard mode and impact function



VIGOR No.	Designation	Design	Size	mm	EAN 4047728+	€
V7124-PH1	Impact screwdriver		PH1	160	071253	14.55
V7124-PH2	Impact screwdriver		PH2	185	071260	14.55
V7124-PH3	Impact screwdriver		PH3	210	071277	14.55
V7124-PZ1	Impact screwdriver		PZ1	185	071284	14.55
V7124-PZ2	Impact screwdriver		PZ2	185	071291	14.55
V7124-T20	Impact screwdriver		T20	160	071307	14.55
V7124-T25	Impact screwdriver		T25	185	071413	14.55
V7124-T30	Impact screwdriver		T30	210	071420	14.55

74.38 €
excl. VAT

TORX® screwdriver

- Manufactured according to DIN/ISO

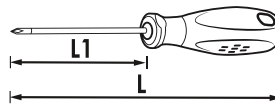

VIGOR No.	Size	L1 mm	mm	EAN 4047728+	€
V4419	T6	74	154	044196	3.67
V4420	T7	74	154	044202	3.67
V4421	T8	74	154	044219	3.67
V4422	T9	74	154	044226	3.67
V3367	T10	100	206	033671	4.31
V3368	T15	100	206	033688	4.74
V3369	T20	100	206	033695	4.74
V3370	T25	100	206	033701	5.07
V3391	T27	100	206	033916	5.50
V3392	T30	100	206	033923	5.50
V3393	T40	100	206	033930	6.25

Screwdrivers and bits



V3366, EAN 4047728**033664**

TORX® screwdriver set

• Manufactured according to DIN/ISO



XX	Design	Size
7 x		T10 · T15 · T20 · T25 · T27 · T30 · T40

29.11 €
excl. VAT

V4418, EAN 4047728**044189**

TORX® screwdriver set

• Manufactured according to DIN/ISO



XX	Design	Size
4 x		T6 · T7 · T8 · T9

12.72 €
excl. VAT



Screwdriver, flexible

- Hose clamps on cooling water hoses
- Working even in confined areas that cannot be reached with a conventional screwdriver
- Design with double spiral spring including plastic coating

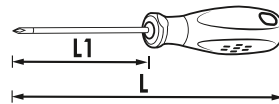

VIGOR No.	Size	mm	EAN 4047728+	€
V4664	6 mm	300	046640	9.49
V4665	7 mm	300	046657	9.49
V4666	8 mm	300	046664	9.49

V5661, EAN 4047728056618

Screwdriver set · flexible

- Hose clamps on cooling water hoses
- Working even in confined areas that cannot be reached with a conventional screwdriver
- Design with double spiral spring including plastic coating



27.70 €
excl. VAT

XX	Design	Size
3 x		6 · 7 · 8 mm

V5485N, EAN 4047728060714

Screwdriver set · extra long · flexible

- Working in areas with restricted access
- Extra long, length: 500 mm
- Universal 6.3 mm (1/4") screwdriver bit socket
- Universal 6.3 mm (1/4") square
- 7 mm 6-point output



51.96 €
excl. VAT



XX	Design	Size
6 x		T10 · T15 · T20 · T25 · T27 · T30
2 x		PH1 · PH2
2 x		1 x 5.5 · 1.2 x 6.5 mm
1 x		500 mm
1 x		500 mm
1 x		7 mm
5 x		5 · 6 · 7 · 8 · 10 mm

V5601, EAN 4047728**056014**

Offset screwdriver set

- In clip
- Long design
- Ball-head
- Contents: 1.5 · 2 · 2.5 · 3 · 4 · 5 · 6 · 7 · 8 · 10 mm



20.⁰⁵ €
excl. VAT

V4942, EAN 4047728**049429**

Offset screwdriver set

- In clip
- Long design
- Ball-head
- Contents: 1.5 · 2 · 2.5 · 3 · 4 · 5 · 6 · 8 · 10 mm



16.⁶⁰ €
excl. VAT

V4708, EAN 4047728**047081**

TORX® offset screwdriver set

- In clip
- Long design
- Ball-head
- Contents: T10 · T15 · T20 · T25 · T27 · T30 · T40 · T45 · T50



27.⁹² €
excl. VAT



V4303, EAN 4047728**043038**

Electronic screwdriver set

- Rotating head section and spinning area
- Four screwdrivers for slotted screws 1.6 · 2 · 2.4 · 3
- Two screwdrivers for Phillips-Recess screws PH00 · PH0
- In plastic box



22.75 €
excl. VAT

XX		Design	Size
4 x	⊖		1.6 · 2 · 2.4 · 3
2 x	⊕		PH0 · PH00

Hexagon T-handle screwdriver

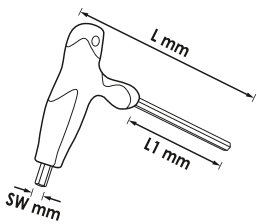

VIGOR No.	Size	L1 mm	L mm	EAN 4047728+	€
V2489	2 mm	100	160	024891	4.42
V2486	2.5 mm	100	160	024860	4.42
V2507	3 mm	100	160	025072	4.42
V2506	4 mm	100	160	025065	5.07
V2505	5 mm	100	160	025058	5.07
V2504	6 mm	132	217	025041	5.17
V2503	8 mm	132	217	025034	6.14
V2502	10 mm	132	217	025027	6.25



V1409, EAN 4047728**014090**

6-point T-handle screwdriver set

- Including holder



Included



34.28 €
excl. VAT

XX		Design	Size
8 x	⊖		2 · 2.5 · 3 · 4 · 5 · 6 · 8 · 10 mm

TORX® T-handle screwdriver

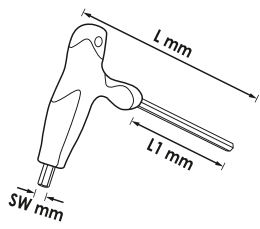

VIGOR No.	Size	L1 mm	L mm	EAN 4047728+	€
V2498	T9	100	160	024983	5.17
V2497	T10	100	160	024976	5.17
V2501	T15	100	160	025010	5.17
V2490	T20	100	160	024907	5.17
V2485	T25	100	160	024853	5.17
V2484	T27	132	217	024846	5.28
V2483	T30	132	217	024839	5.50
V2482	T40	132	217	024822	6.36

V1410, EAN 4047728014106

TORX® T-handle screwdriver set



Included



39.78 €
excl. VAT

XX	Design	Size
8 x		T9 · T10 · T15 · T20 · T25 · T27 · T30 · T40

V4199, EAN 4047728041997

Hex nut-driver set

• Surface: chrome-plated



50.67 €
excl. VAT

XX	Design	Size
6 x		6 · 7 · 8 · 10 · 12 · 13 mm



Hex-nut driver

• Surface: chrome-plated

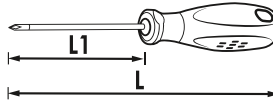

VIGOR No.	Size	L1 mm	EAN 4047728+	€
V4200	6 mm	150	042000	8.41
V4221	7 mm	150	042215	8.41
V4222	8 mm	150	042222	8.73
V4223	10 mm	150	042239	9.27
V4224	12 mm	150	042246	9.59
V4225	13 mm	150	042253	9.92

Bit screwdriver



VIGOR No.	mm	EAN 4047728+	€
V3427N	200	058865	11.32



Screwdrivers and bits



V5019, EAN 4047728**050197**

Bit box

• ~ DIN / ISO



			Design	Size
7 x				T10 · T15 · T20 · T25 · T27 · T30 · T40
4 x				3 · 4 · 5 · 6 mm
4 x				PH1 · PH2 (2x) · PH3
4 x				PZ1 · PZ2 (2x) · PZ3
4 x				0.5x3 · 0.8x4 · 1x5 · 1x6 mm
7 x				T10H · T15H · T20H · T25H · T27H · T30H · T40H
1 x				60 mm
1 x				25 mm

Including sales display for a purchase of at least 10 pieces



20.48 €
excl. VAT

V5502, EAN 4047728**055024**

Bit box

• Work with screws in the workshop, industry, trade, at home and for hobby use
• ~ DIN / ISO



			Design	Size
7 x				T10 · T15 · T20 · T25 · T27 · T30 · T40
4 x				3 · 4 · 5 · 6 mm
4 x				PH1 · PH2 (2x) · PH3
4 x				PZ1 · PZ2 (2x) · PZ3
4 x				0.5x3 · 0.8x4 · 1x5 · 1x6 mm
7 x				T10H · T15H · T20H · T25H · T27H · T30H · T40H
1 x	-			95 mm
1 x				60 mm

33.42 €
excl. VAT



V5020, EAN 4047728050203

Bit box

• ~ DIN / ISO



XX	■	●	Design	Size
7 x	6.3 1/4			T10 · T15 · T20 · T25 · T27 · T30 · T40
2 x	6.3 1/4			T20 · T25
3 x	6.3 1/4			3 · 4 · 5 mm
9 x	6.3 1/4			PH1 (3x) · PH2 (3x) · PH3 (3x)
2 x	6.3 1/4			PH1 · PH2
9 x	6.3 1/4			PZ1 (3x) · PZ2 (3x) · PZ3 (3x)
2 x	6.3 1/4			PZ1 · PZ2
6 x	6.3 1/4			0.5x3 (2x) · 0.8x4 (2x) · 1x5 mm (3x)
1 x	6.3 1/4			1x6 mm
14 x	6.3 1/4			T10H (2x) · T15H (2x) · T20H (2x) · T25H (2x) · T27H (2x) · T30H (2x) · T40H (2x)
1 x	6.3 1/4	6.3 1/4		60 mm
1 x	6.3 1/4	6.3 1/4		25 mm

38.81 €
excl. VAT

V6068, EAN 4047728060684

Bit box

• ~ DIN / ISO



Including sales display for a purchase of at least 10 pieces



XX	■	●	Design	Size
7 x	6.3 1/4			T10 · T15 · T20 · T25 · T27 · T30 · T40
4 x	6.3 1/4			3 · 4 · 5 · 6 mm
4 x	6.3 1/4			PH1 · PH2 (2x) · PH3
3 x	6.3 1/4			PZ1 · PZ2 · PZ3
4 x	6.3 1/4			0.5x3 · 0.8x4 · 1x5 · 1.2x6.5 mm

38.81 €
excl. VAT

Pliers



V5650, EAN 4047728056502

Diagonal cutter with double joint

- Extremely slim design
- For working in areas with restricted access

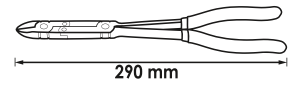

38.81 €
excl. VAT

V2781, EAN 4047728027816

Combination pliers with double joint

- Toothed, extremely slim design
- For working in areas with restricted access

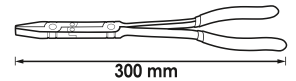

38.81 €
excl. VAT

V2782, EAN 4047728027823

Snipe nose pliers with double joint

- Toothed, extremely slim design
- For working in areas with restricted access

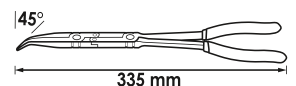
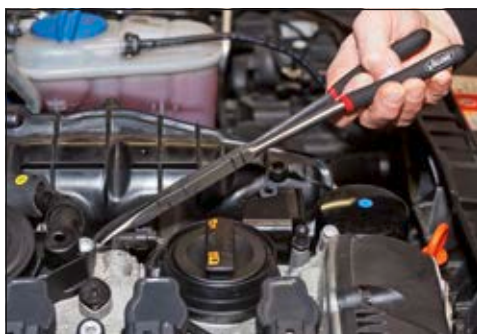

38.81 €
excl. VAT



V2783, EAN 4047728027830

Snipe nose pliers with double joint

- Toothed, extremely slim design
- For working in areas with restricted access

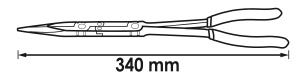

38.81 €
excl. VAT

V5493, EAN 4047728054935

Spark plug pliers with double joint

- Installing and removing hard-to-reach spark plug sockets
- Also for severing fuel line connections
- 45° angled head

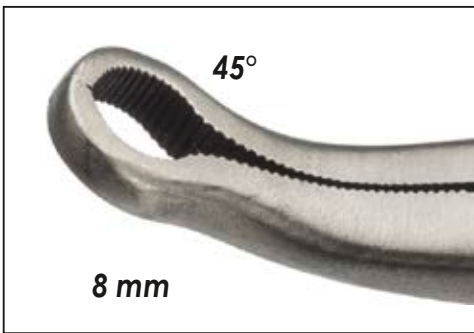

Safe application thanks to integrated teeth

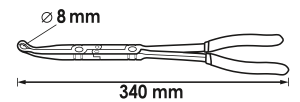

38.92 €
excl. VAT

V5494, EAN 4047728054942

Spark plug pliers with double joint

- Installing and removing hard-to-reach spark plug sockets
- Also for severing fuel line connections
- 45° angled head



Safe application thanks to integrated teeth

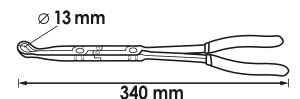

38.81 €
excl. VAT

V5496, EAN 4047728054966

Circlip pliers with double joint · inside locking

- Inside lockrings (bore holes) 8 – 30 mm Ø
- Particularly simple tip replacement
- Colour coded tips
- Design tips / contents:
 - 2x Ø 1.0 mm straight
 - 2x Ø 1.0 mm 90° angled
 - 2x Ø 1.3 mm straight
 - 2x Ø 1.3 mm 90° angled
 - 2x Ø 1.8 mm straight
 - 1 x inside hexagon socket wrench



Double joint exponentially increases and transmits even the smallest of handle movements to the tips

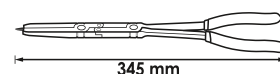

58.86 €
excl. VAT

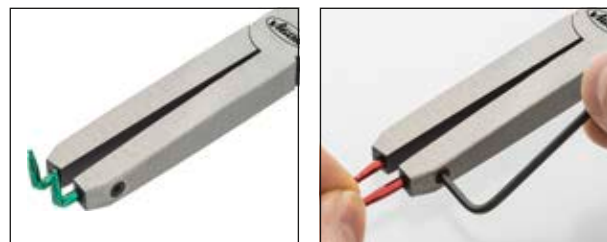

V5496-1, EAN 4047728054980

Replacement tip set for circlip pliers with double joint

- Circlip pliers with double joint V5496 · V5497
- Contents:
 - 2x Ø 1.0 mm · straight
 - 2x Ø 1.0 mm · 90° angled
 - 2x Ø 1.3 mm · straight
 - 2x Ø 1.3 mm · 90° angled
 - 2x Ø 1.8 mm · straight
 - 1 x inside hexagon socket wrench



17.79 €
excl. VAT

V5497, EAN 4047728054973

Circlip pliers with double joint · outside locking

- Outside lockrings (shafts) 12 – 30 mm Ø
- Particularly simple tip replacement
- Colour coded tips
- Design tips / contents:
 - 2x Ø 1.0 mm straight
 - 2x Ø 1.0 mm 90° angled
 - 2x Ø 1.3 mm straight
 - 2x Ø 1.3 mm 90° angled
 - 2x Ø 1.8 mm straight
 - 1 x inside hexagon socket wrench



Double joint exponentially increases and transmits even the smallest of handle movements to the tips

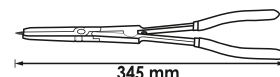

58.86 €
excl. VAT



V4441, EAN 4047728044417

Circlip pliers set · 140 mm

- Contents:
 - Circlip pliers for inside lockrings V4427 (straight style) · V4428 (bent style)
 - Circlip pliers for outside lockrings V4429 (straight style) · V4430 (bent style)



95.94 €
excl. VAT

V4442, EAN 4047728044424

Circlip pliers set · 180 mm

- Contents:
 - Circlip pliers for inside lockrings V1716 (straight style) · V1718 (bent style)
 - Circlip pliers for outside lockrings V1717 (straight style) · V1719 (bent style)

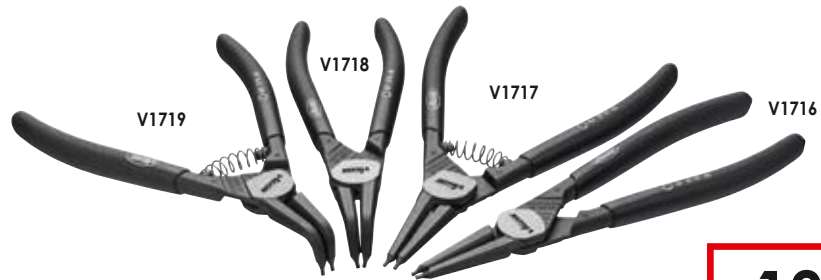

102.50 €
excl. VAT

Circlip pliers

- For outside lockrings
- Straight design · form A
- DIN 5254 form A

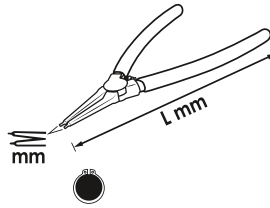

VIGOR No.	mm	mm	L mm	EAN 4047728+	€
V4429	10-25 mm	1.3	140	044295	26.52
V1717	19-60 mm	1.8	180	017176	29.21
V2792	40-100 mm	2.3	180	027922	38.38

Circlip pliers

- For outside lockrings
- Tips 90° angled · form B
- DIN 5254 form B

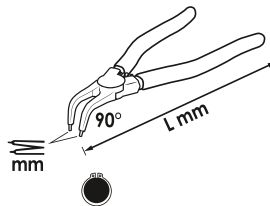
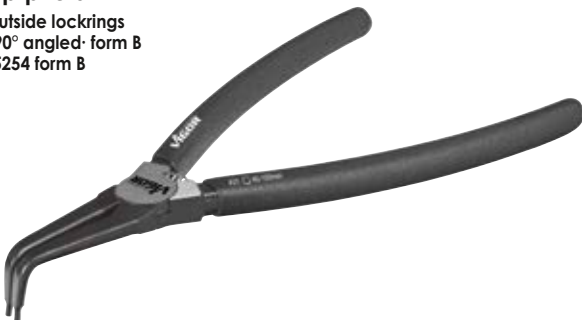

VIGOR No.	mm	mm	L mm	EAN 4047728+	€
V4430	10-25 mm	1.3	140	044301	26.52
V1719	19-60 mm	1.8	180	017190	29.21
V2791	40-100 mm	2.3	180	027915	38.38

Circlip pliers

- For inside lockrings
- Straight design · form C
- DIN 5256 form C

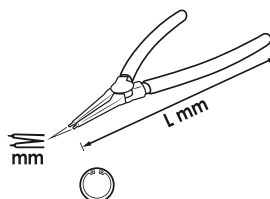

VIGOR No.	mm	mm	L mm	EAN 4047728+	€
V4427	12-25 mm	1.3	140	044271	26.52
V1716	19-60 mm	1.8	180	017169	29.21
V2794	40-100 mm	2.3	180	027946	38.38

Circlip pliers

- For inside lockrings
- Tips 90° angled - form D
- DIN 5256 form D

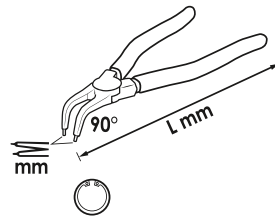

VIGOR No.	mm	mm	L mm	EAN 4047728+	€
V4428	10-25 mm	1.3	140	044288	26.52
V1718	19-60 mm	1.8	180	017183	29.21
V2793	40-100 mm	2.3	180	027939	38.38

Grip pliers with curved jaws

- Safe gripping of nuts or screw heads
- Size adjustment with adjusting screw
- Locking element on handle
- Toothed inside of jaws
- Ergonomically shaped, easy to handle
- Chrome Molybdenum
- Nickel-plated

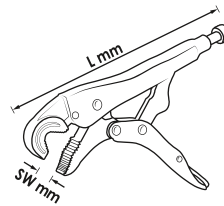

Wire cutter



VIGOR No.	Size	L mm	EAN 4047728+	€
V3738-S	6 - 13 mm	100	069540	19.40
V3738	11 - 19 mm	175	037389	23.50
V3739	16 - 27 mm	250	037396	27.70

V1808, EAN 4047728018081

Grip pliers set

- Size adjustment with adjusting screw
- Locking element on handle
- Toothed inside of jaws
- Ergonomically shaped, easy to handle
- Chrome Molybdenum
- Nickel-plated



Delivery in practical tool roll



59.51 €
excl. VAT

VIGOR No.	Designation	Design	L mm	EAN 4047728+	€
V1802	Grip pliers with long jaws		150	018029	18.33
V1803	Grip pliers with long jaws		250	018036	21.78
V1804	Grip pliers with long jaws		125	018043	19.40

V4637N, EAN 4047728075565

Hose and spring band hose clamp pliers

- Operation of self-gripping hose clamps and spring band hose clamps which are hard to reach
- Bowden cable locking element for temporary holding of the clamp
- Easy release of the lock due to internal spring
- Fatigue-free work due to internal spring in handle
- Total length of bowden cable: 590 mm
- Clamping range: 18-53 mm



NEW



86.40 €
excl. VAT

V4737, EAN 4047728075572

Fuel line pliers

- Operation of hard-to-reach fuel line clutches
- Flexible bowden cable
- No damage to the clutches and hoses due to proper operation of quick-release fasteners
- Bowden cable locking element facilitates precise adjustment of the range
- Easy release of the lock due to internal spring
- Total length of bowden cable: 590 mm
- Opening width: 30 mm



NEW



132.- €
excl. VAT

V4641, EAN 4047728075558

Clamp pliers

- Operation of stepless and earless clamps on axle boots (also thermoplast axle boots)
- Precise tightening through even compression



NEW



65.80 €
excl. VAT

Pliers



V4196, EAN 4047728**041966**

Pliers for plastic rivets



Including 40 plastic rivets

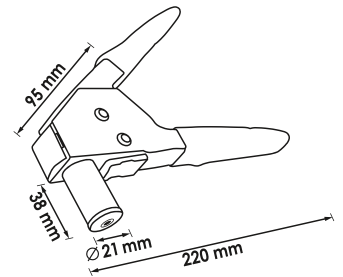

82.36 €
excl. VAT



V5681, EAN 4047728056816

Electronic diagonal cutter

- For wire classes:
 - Soft up to \varnothing 1.6 mm
 - Medium-hard up to \varnothing 1.2 mm
 - Hard up to \varnothing 0.8 mm

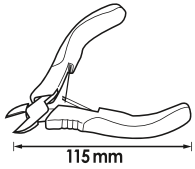

ESD version

2
K

21.24 €
excl. VAT

V1616, EAN 4047728016162

Combination pliers

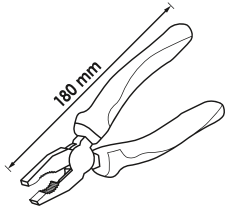

2
K

17.14 €
excl. VAT

V1617, EAN 4047728016179

Diagonal cutter

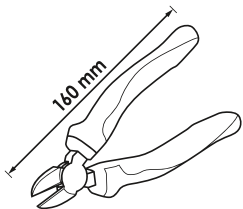

2
K

17.14 €
excl. VAT

V2412, EAN 4047728024129

Snipe nose pliers

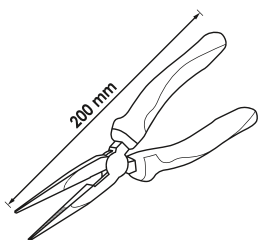

2
K

18.87 €
excl. VAT

V1426N, EAN 4047728064392

Universal pliers

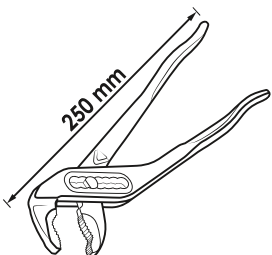

10.46 €
excl. VAT

Pliers



V5630, EAN 4047728056304

Universal pliers

- Handle with plastic cover
- Highest stability of the slip joint due to double guide
- Clamping protection prevents crushing injuries in case of uncontrolled application
- Inner gripping areas with special hardened toothing offers non-skidding grip on the workpiece
- Pliers individually tempered and hardened

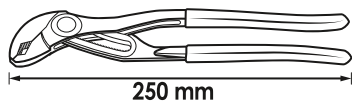

MADE IN GERMANY

Quick adjustment



47.- €
excl. VAT

V1785, EAN 4047728017855

Multi-tool 14 in 1

Included



35.36 €
excl. VAT

V6799, EAN 4047728067997

Flexible hose clamp set

- Disconnecting flexible hose lines
- Secure, adjustable latching
- Maintenance work with petrol, radiator antifreeze, oil, etc.
- Temperature resistance up to 220 °C

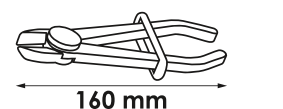
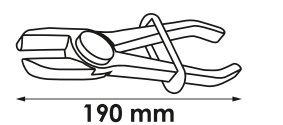
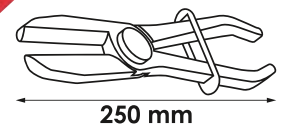

22.75 €
excl. VAT

V3735, EAN 4047728**037358**

Hand riveting tool for blind rivets and rivet nuts · universal

- Rivet nuts: M5 · M6 · M8 · M10 for rivets made of copper, brass, steel and stainless steel
- Blind rivets: 3.2 · 4.0 · 4.8 · 6.4 mm for rivets made of copper, brass, steel and stainless steel



Spare parts

VIGOR No.	Designation	EAN 4047728+	€
V3735-3.2	Mouthpiece for blind rivets · 3.2 mm	053976	3.99
V3735-4.0	Mouthpiece for blind rivets · 4.0 mm	053617	3.99
V3735-4.8	Mouthpiece for blind rivets · 4.8 mm	053624	3.99
V3735-6.4	Mouthpiece for blind rivets · 6.4 mm	053631	3.99
V3735-M5	Mouthpiece for rivet nuts · M 5	053495	23.39
V3735-M6	Mouthpiece for rivet nuts · M 6	053501	23.39
V3735-M8	Mouthpiece for rivet nuts · M 8	053518	23.39
V3735-M10	Mouthpiece for rivet nuts · M 10	053525	23.39

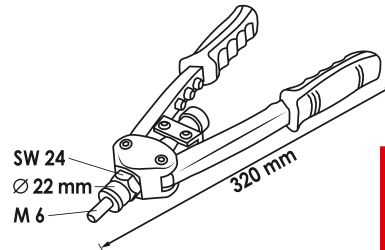

152.- €
excl. VAT

V2788, EAN 4047728**027885**

Blind rivet pliers

- For blind rivets: 3.2 · 4.0 · 4.8 · 6.4 mm
- For rivets made of copper, brass, steel and stainless steel
- Very low power required, extra short design



Spare parts

VIGOR No.	Designation	EAN 4047728+	€
V2788-3.2	Mouthpiece for blind rivets · 3.2 mm	053648	3.99
V2788-4.0	Mouthpiece for blind rivets · 4.0 mm	053655	3.99
V2788-4.8	Mouthpiece for blind rivets · 4.8 mm	053662	3.99
V2788-6.4	Mouthpiece for blind rivets · 6.4 mm	053679	3.99

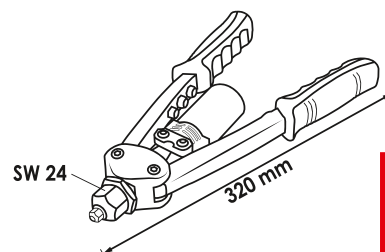

82.36 €
excl. VAT

V3343, EAN 4047728**033435**

VDE socket set

- VDE insulated up to 1000 V as per DIN EN 60900
- IEC 60900:2018
- For manual operation

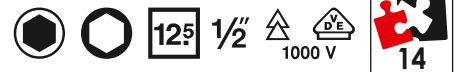

377.50 €
excl. VAT

Single parts see page 214

XX	■	●	Design	Size
9 x	125 1/2	●		8 · 10 · 12 · 13 · 14 · 17 · 19 · 22 · 24 mm
3 x	125 1/2	○		5 · 6 · 8 mm
1 x	125 1/2	125 1/2		125 mm
1 x	-	125 1/2		255 mm



VDE reversible ratchet

12⁵ 1/2' 1000 V



VIGOR No.	mm	EAN 4047728+	€
V3342	255	033428	132.-

VDE extension

12⁵ 1/2' 1000 V



VIGOR No.	mm	EAN 4047728+	€
V3341	125	033411	37.73

VDE socket

12⁵ 1/2' 1000 V



VIGOR No.	Size	mm	EAN 4047728+	€
V3330	8 mm	55	033305	18.33
V3331	10 mm	55	033312	18.33
V3332	12 mm	55	033329	19.94
V3333	13 mm	55	033336	19.94
V3334	14 mm	55	033343	19.94
V3335	17 mm	55	033350	21.13
V3336	19 mm	55	033367	22.75
V3337	22 mm	55	033374	23.93
V3338	24 mm	55	033381	25.55

VDE screwdriver socket

12⁵ 1/2' 1000 V



VIGOR No.	Size	mm	EAN 4047728+	€
V3339	5 mm	78	033398	27.81
V3344	6 mm	78	033442	27.81
V3340	8 mm	78	033404	27.81

V2027, EAN 4047728**020275**

VDE screwdriver set

• Manufactured according to DIN/ISO



33.31 €
excl. VAT

		Design	Size
4 x			0.5x3 · 0.8x4 · 1x5.5 · 1.2x6.5 mm
3 x			PH0 · PH1 · PH2

VDE screwdriver for slotted screws

• Manufactured according to DIN/ISO

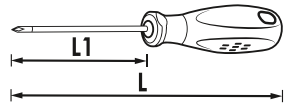
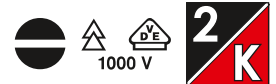

VIGOR No.	Size	L1 mm	L mm	EAN 4047728+	€
V2028	0.5x3 mm	100	181	020282	4.10
V2029	0.8x4 mm	100	181	020299	4.74
V2030	1x5.5 mm	125	231	020305	5.93
V2061	1.2x6.5 mm	150	256	020619	7.22

VDE Phillips-Recess screwdriver

• Manufactured according to DIN/ISO

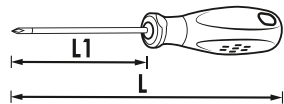
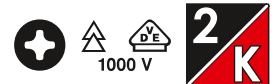

VIGOR No.	Size	L1 mm	L mm	EAN 4047728+	€
V2062	PH0	60	141	020626	4.10
V2063	PH1	80	161	020633	5.28
V2064	PH2	100	206	020640	6.58

Voltmeter



VIGOR No.	Size	L mm	EAN 4047728+	€
V1138	0.5x3 mm	140	011389	5.50



V2641, EAN 4047728026413

VDE round nose pliers

• Long jaws

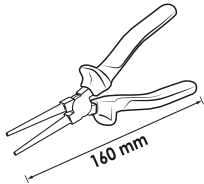

24.26 €
excl. VAT

V2628, EAN 4047728026284

VDE combination pliers

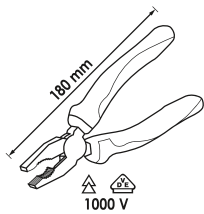

23.72 €
excl. VAT

V2629, EAN 4047728026291

VDE diagonal cutter

• For hard wire (H)

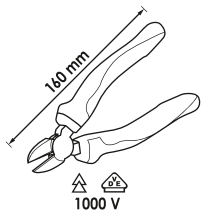

24.26 €
excl. VAT

V2630, EAN 4047728026307

VDE snipe nose pliers

• With blade

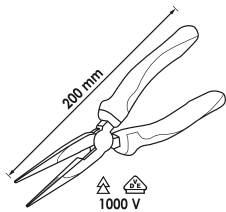

25.98 €
excl. VAT

V2643, EAN 4047728026437

VDE wire stripper

• Spring and adjusting screw

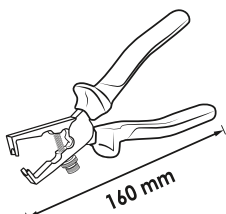

24.79 €
excl. VAT

Machinist's hammer

- Ash stick



VIGOR No.	— L — mm	⚖ g	EAN 4047728+	€
V1135	300	300	011358	10.56
V2662	320	500	026628	13.48
V2665	350	800	026659	17.79
V2664	360	1000	026642	19.94
V2663	400	2000	026635	27.70

Club hammer

- Ash stick



VIGOR No.	— L — mm	⚖ g	EAN 4047728+	€
V4235	280	1500	042352	23.93

Plastic soft-faced hammer

- Replaceable heads made from impact-resistant cellulose acetate
- Ash stick



VIGOR No.	Diameter max	— L — mm	EAN 4047728+	€
V1212	32	280	012126	17.25
V4661	40	320	046619	25.87



VIGOR No.	Designation	∅ mm	EAN 4047728+	€
V3541	Spare head (pair) for plastic soft-faced hammer V1212	32	035415	7.22
V4661-1	Spare head (pair) for plastic soft-faced hammer V4661	40	048514	7.55



V1221, EAN 4047728012218

Flat chisel

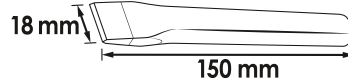

11.-€
excl. VAT

V1222, EAN 4047728012225

Cape chisel

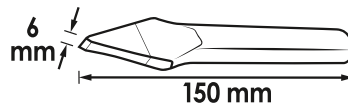

11.-€
excl. VAT

V1220, EAN 4047728012201

Centre punch

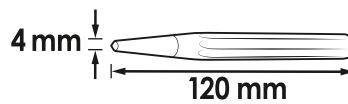

5.28 €
excl. VAT

V1783, EAN 4047728017831

Centre punch · self-punching

• The impact force is applied by simply pressing down the upper part



Progressively adjustable

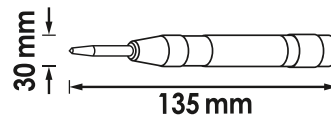

21.02 €
excl. VAT

Drift pin



VIGOR No.	∅ mm	L mm	EAN 4047728+	€
V1214	2	150	012140	6.47
V1215	3	150	012157	6.47
V1216	4	150	012164	6.47
V1217	5	150	012171	6.47
V1218	6	150	012188	6.47
V1219	8	150	012195	7.01

V1283, EAN 4047728012836

Scraper set · stainless steel

- Removing sealing residues on cylinder head lid, valve cover, carburetor cover gaskets, etc.
- Stainless steel blades
- Hanging hole
- Set of 4 pieces

With impact cap

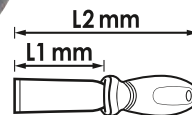

VIGOR No.	mm	mm	Chisel height	EAN 4047728+	€
V2487	230	32	1.2	024877	10.24
V2488	230	32	2.5	024884	11.86
V2509	175	20	1.2	025096	10.24
V2508	175	20	2.5	025089	11.86

43.01 €
excl. VAT

V1368N, EAN 4047728071017

Universal scraper

- Removal of vignettes, badges and stickers
- Also suitable for ceramic glass cooktop, windscreen, etc.
- Blade can be replaced quickly and safely
- Including one blade



12.83 €
excl. VAT

V1372, EAN 4047728013727

Spare blades



2.91 €
excl. VAT

V1213, EAN 4047728012133

Gasket scraper · long

- Removing sealing residues on cylinder head lid, valve cover, carburetor cover gaskets, etc.
- Long design
- Plastic handle



25.76 €
excl. VAT

V4663, EAN 4047728046633

Mini hook set

- Inserting and removing O-rings or seals
- Also for removing the protection caps on wheel bolts
- Hanging hole
- Short design



11.32 €
excl. VAT

V5045, EAN 4047728050456

Hook and scraper set

- Removing and inserting O-rings and seals and for removing stickers and the remains of seals and adhesive
- Also for removing the protection caps on wheel bolts
- With hanging hole

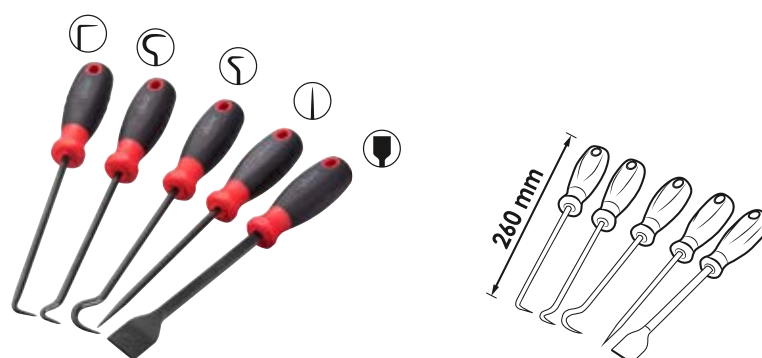

31.26 €
excl. VAT

V6210-4, EAN 4047728065948

Centre punch

- Labelling of components to be processed
- Ergonomic two-component handle
- Safe gripping
- Reduced vibrations when hitting
- Elongated impact cap
- Tip Ø 4 mm
- Centre punch 4x10x185 mm



7.44 €
excl. VAT

V6210-10, EAN 4047728065931

Centre punch

- Labelling of components to be processed
- Ergonomic two-component handle
- Safe gripping
- Reduced vibrations when hitting
- Elongated impact cap
- Tip Ø 10 mm
- Centre punch 10x12x185 mm



9.59 €
excl. VAT

V6230-5, EAN 4047728065986

Cape chisel

- Safe, easy disconnection of components or parts
- Ergonomic two-component handle
- Safe gripping
- Reduced vibrations when hitting
- Elongated impact cap
- Blade width: 5 mm
- Cape chisel 5x10x170 mm



8.52 €
excl. VAT

V6230-7, EAN 4047728065993

Cape chisel

- Safe, easy disconnection of components or parts
- Ergonomic two-component handle
- Safe gripping
- Reduced vibrations when hitting
- Elongated impact cap
- Blade width: 7 mm
- Cape chisel 7x12x190 mm



10.67 €
excl. VAT

V6200, EAN 4047728061940

Drift pin set

- Ergonomically 2-component handle
- Safe gripping
- Significantly reduced risk of injury thanks to hand guard
- Reduced vibrations when hitting
- Elongated impact cap
- 7 different sizes (driving mandrel Ø 2 – 8 mm)
- Storage in practical tool roll



53.79 €
excl. VAT

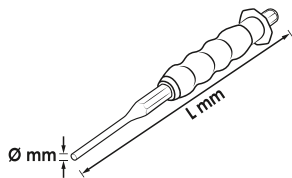

VIGOR No.	Ø	mm	EAN 4047728+	€
V6200-2	2	140	061957	7.65
V6200-3	3	150	061964	7.65
V6200-4	4	180	061971	7.65
V6200-5	5	200	061988	7.65
V6200-6	6	210	061995	7.65
V6200-7	7	210	062008	7.65
V6200-8	8	220	062015	8.73



V6220/4, EAN 4047728066006

Flat chisel set

- Safe, easy disconnection of components or parts
- Ergonomic two-component handle
- Safe gripping
- Reduced vibrations when hitting
- Elongated impact cap
- 4 different sizes: 10 · 16 · 20 · 29 mm
- Storage in practical tool roll



53.15 €
excl. VAT

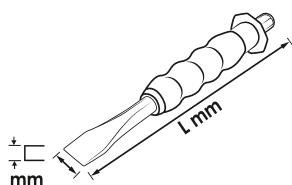

VIGOR No.	mm	mm	Chisel height	EAN 4047728+	€
V6220-10	140	10	8	065955	7.44
V6220-16	170	16	10	065962	8.52
V6220-20	210	20	14	065979	14.98
V6220-29	250	29	18	063890	21.45



V6030, EAN 4047728060301

Scraper set

- Removing badges, stickers, vignettes or adhesive residue, etc.
- Further application fields: removal of motor seals, e.g. on the cylinder head or valve cover
- Blades can be easily replaced by loosening the screw connection on the chuck
- Different blades enable adaptation to different application fields



VIGOR No.	Designation	Width mm	EAN 4047728+	€
V6030-12	Spare blades	12	062121	3.34
V6030-16	Spare blades	16	062138	3.34
V6030-20	Spare blades	20	062145	3.34

28.57 €
excl. VAT

V1371, EAN 4047728069687

Removal lever set

- Ideal for working on door panels, dashboards, rubber seals, decorative strips, etc.
- Slim and robust design
- Versatile in use in workshop or household



VIGOR No.	EAN 4047728+	€
V1371-1	069649	8.09
V1371-2	069700	8.09
V1371-3	069656	8.09
V1371-4	069694	8.09
V1371-5	069670	8.09
V1371-6	069632	8.09
V2491	024914	7.55
V2492	024921	7.55
V2493	024938	7.55
V2494	024945	7.55
V2495	024952	7.55

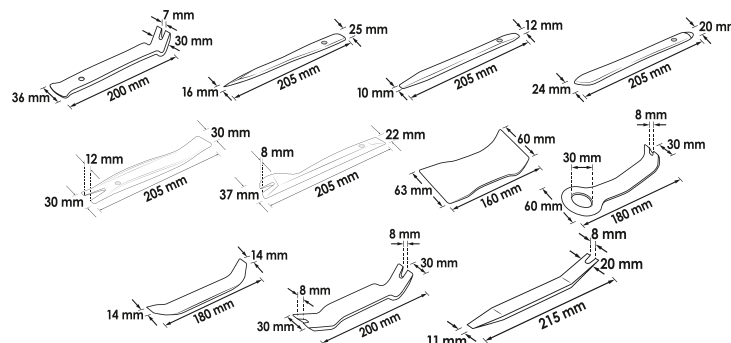

In practical tool roll



37.62 €
excl. VAT

Impact and releasing tools, scrapers



V1369, EAN 4047728013697

Removal lever set

- Ideal for working on door panels, dashboards, rubber seals, decorative strips, etc.
- Does not cause scratches
- Slim and robust design
- Versatile in use in workshop or household

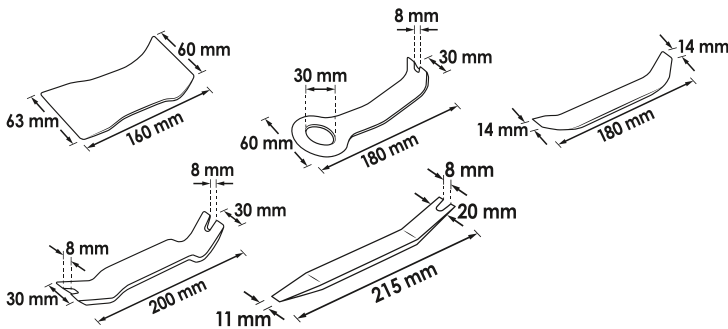

VIGOR No.	l mm	h mm	EAN 4047728+	€
V2491	160	60	024914	7.55
V2492	180	30	024921	7.55
V2493	180	20	024938	7.55
V2494	200	30	024945	7.55
V2495	210	20	024952	7.55

30.08 €
excl. VAT

V5885, EAN 4047728073851

Clip loosening set

- Metal and plastic clips of vehicle trims
- Hanging hole

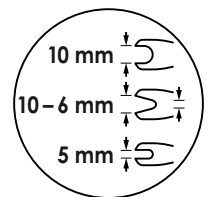
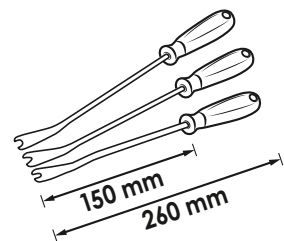

32.56 €
excl. VAT

V4885, EAN 4047728048859

Clip loosening set

- Metal and plastic clips of vehicle trims
- Hanging hole

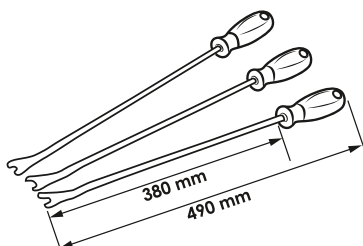

50.67 €
excl. VAT

V4310N, EAN 4047728062817

Release lever

- Slim design – for working in areas that are difficult to access e.g. for removing the plastic clips from door and tailgate trims
- Length: 165 mm

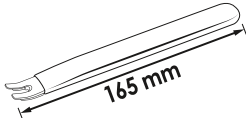

Plastic sleeve for damage-free work



14.34 €
excl. VAT

V1301, EAN 4047728013017

Pry bar set

- Impact-resistant handle

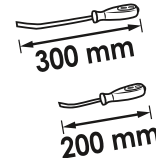
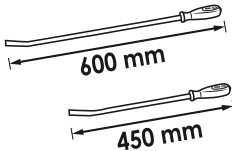

38.81 €
excl. VAT

V6952, EAN 4047728069526

Mini removal lever set

- Replacing the batteries in car keys or working on the dashboard
- Convenient, fine and versatile in use

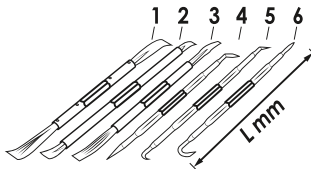

L (mm)
1 190
2 185
3 185
4 165
5 170
6 170

Damage-free working
on lacquered areas



22.64 €
excl. VAT

V5591, EAN 4047728055918

Tape measure

- Determining short distances up to 5 m accurate to the millimetre
- Length: 5 m, width: 19 mm
- Wrist strap and belt clip
- Magnetic stopper
- Hand-regulated belt feed and belt stop
- Spring band steel



7.22 €
excl. VAT

V1714, EAN 4047728017145

Feeler gauge set

- Testing of gap dimensions, contact gaps, hollow spaces
- Locknut
- Sheets conically shaped
- 20 sheets
- 0.05 – 1.00 mm



11.- €
excl. VAT

Various hand tools Cutting and sawing



V4690, EAN 4047728046909

Vernier calliper · analogue

- External and internal measurements in the 0 – 150 mm range
- Millimetre and inch increments
- Nonius 0.05 mm and 1/128"
- Fixing screw
- Dipstick
- In plastic box
- DIN 862



33.42 €
excl. VAT

V1713, EAN 4047728017138

Vernier calliper · digital

- External and internal measurements in the 0 – 150 mm range
- Millimetre and inch increments
- Digital display
- 1.5 V (LR 44) – 180 mAh
- Fixing screw
- Dipstick
- In plastic box



Can be switched between mm / inches

44.74 €
excl. VAT

V1304, EAN 4047728013048

Universal scissors

- Long, high-quality cutting edges
- Stainless steel blade

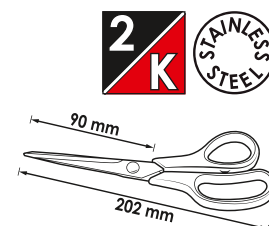
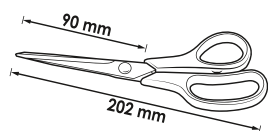

6.36 €
excl. VAT

V2790N, EAN 4047728075664

Hack saw · small

- Standard saw blades

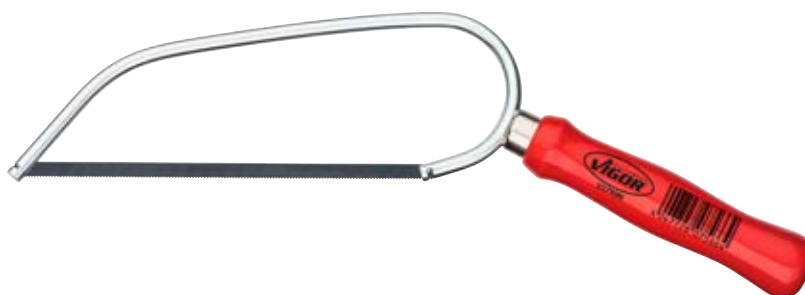
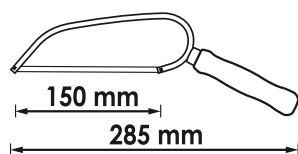

NEW

9.90 €
excl. VAT

V1715, EAN 4047728017152

Saw frame

- Standard saw blades

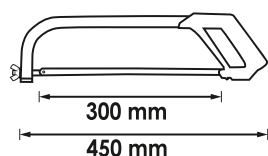

17.68 €
excl. VAT



V4651, EAN 4047728046510

Jack-knife · outdoor

- Blade length: 86 mm
- Total length: 185 mm
- Stainless steel blade
- Aluminium grip housing



With locking element

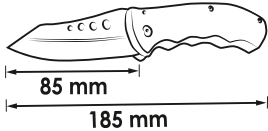

17.25 €
excl. VAT

V2627, EAN 4047728026277

Universal knife

- Snap-off blade 9 mm
- Housing made of stainless steel
- Pocket clip

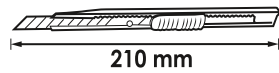

3.45 €
excl. VAT



V4308, EAN 4047728043083

Snap-off blades · 9 mm

- Blades consist of 12 individual blades, which can be easily separated after wearing down
- For universal knife V2627



2.26 €
excl. VAT

V4275, EAN 4047728042758

Universal knife

- Anti-slip convenient handle
- Steel-guided blade fixed for minimising accidents
- Quick-change magazine
- Includes 6 snap-off blades (V4274)

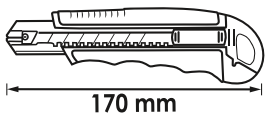

7.98 €
excl. VAT



V4274, EAN 4047728042741

Snap-off blades · 18 mm

- Blades consist of eight individual blades, which can be easily separated after wearing down
- For universal knife V4275



2.59 €
excl. VAT

V1345, EAN 4047728013451

Universal knife

- Aluminium housing
- Quick-change magazine
- Including 10 trapezoid spare blades (V1446)

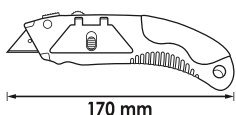

17.14 €
excl. VAT



V1446, EAN 4047728014465

Trapezoid spare blades

- Can be used in two different ways due to trapezoidal shape
- For universal knife V1345 · V7099
- With two sockets



5.71 €
excl. VAT

V7099, EAN 4047728070997

Universal jack-knife

- Universal use in the warehouse, garden, household, workshop or in industry
- Foldable, therefore reduced risk of injury
- Blade lock in open position
- Fast blade changes
- High-quality aluminium housing



11.- €
excl. VAT

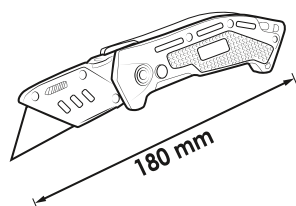

V1446, EAN 4047728014465

Trapezoid spare blades

- Can be used in two different ways due to trapezoidal shape
- For universal knife V1345 · V7099
- With two sockets



5,71 €
excl. VAT

V7099-S, EAN 4047728071000

Universal jack-knife · mini

- Universal use in the warehouse, garden, household, workshop or in industry
- Foldable, therefore reduced risk of injury
- Blade lock in open position
- Fast blade changes
- High-quality aluminium housing



8,84 €
excl. VAT

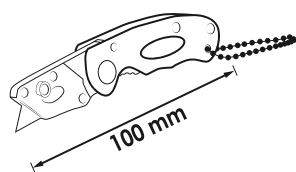

V1447, EAN 4047728070966

Trapezoid spare blades

- Can be used in two different ways due to trapezoidal shape
- For universal knife V7099-S



3,02 €
excl. VAT

V7099/2, EAN 4047728071123

Universal jack-knife set

- Universal use in the warehouse, garden, household, workshop or in industry
- Foldable, therefore reduced risk of injury
- Blade lock in open position
- Fast blade changes
- High-quality aluminium housing



16,06 €
excl. VAT



V1787, EAN 4047728017879

Flat hand file

- Teeth (cut): 2 = medium
- DIN 7261

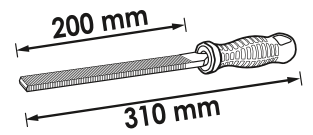

12.40 €
excl. VAT

V1788, EAN 4047728017886

Three square file

- Teeth (cut): 2 = medium
- DIN 7261

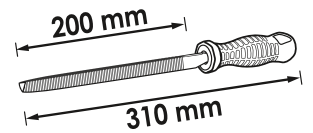

12.40 €
excl. VAT

V1789, EAN 4047728017893

Square file

- Teeth (cut): 2 = medium
- DIN 7261

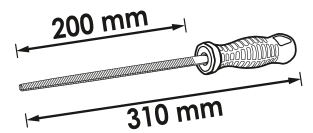

12.40 €
excl. VAT

V1790, EAN 4047728017909

Half-round file

- Teeth (cut): 2 = medium
- DIN 7261

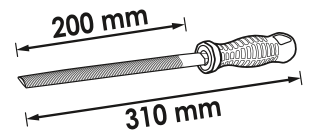

14.55 €
excl. VAT

V1801, EAN 4047728018012

Round file

- Teeth (cut): 2 = medium
- DIN 7261

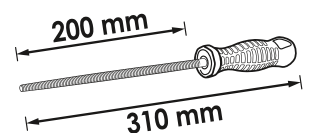

12.40 €
excl. VAT

Cutting and sawing



V6809-4, EAN 4047728067720

Steel · wire brush · 4 rows

- Steel working
- Steel bristles
- Wire: 0.30 mm



4.20 €
excl. VAT

V6807-4, EAN 4047728067713

Brass · wire brush · 4 rows

- Gentle handling of sensitive surfaces
- Brass bristles
- Wire: 0.30 mm



6.58 €
excl. VAT



V6800-50, EAN 4047728067621

Cup brush · coarse

- Removal of coarse sediments and residues as well as stubborn rust
- Steel wire
- 6 mm clamping shaft
- Maximum 4500 rpm
- 50 mm Ø
- Trim size: 17 mm

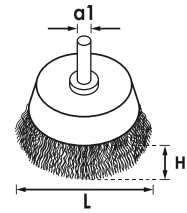

3.34 €
excl. VAT

V6800-75, EAN 4047728067638

Cup brush · coarse

- Removal of coarse sediments and residues as well as stubborn rust
- Steel wire
- 6 mm clamping shaft
- Maximum 4500 rpm
- 75 mm Ø
- Trim size: 20 mm

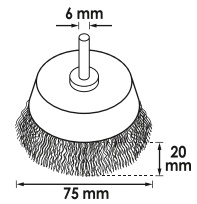

3.99 €
excl. VAT

V6802, EAN 4047728067645

Wire end brush

- Deburring, paint removal, rust removal and cleaning
- Steel wire
- 25 mm Ø
- 6 mm clamping shaft
- Maximum 4500 rpm

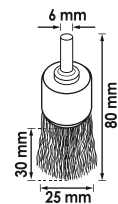

5.07 €
excl. VAT

V6803-100, EAN 4047728067669

Wheel brush

- Removal of tempered colour on weld seams
- Steel wire
- 6 mm clamping shaft
- Maximum 4500 rpm
- 100 mm Ø

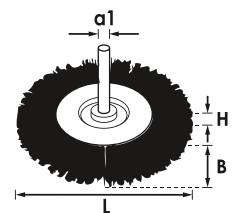

6.58 €
excl. VAT

V6803-75, EAN 4047728067652

Wheel brush

- Removal of tempered colour on weld seams
- Steel wire
- 6 mm clamping shaft
- Maximum 4500 rpm
- 75 mm Ø

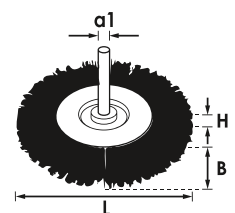

5.50 €
excl. VAT

V6806, EAN 4047728067676

Wheel brush · coarse

- Removal of coarse sediments and residues as well as stubborn rust or scaling
- Steel wire
- Design with knotted wire
- 75 mm Ø
- Maximum 12500 rpm

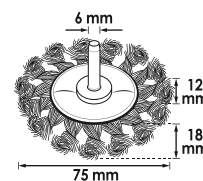

9.49 €
excl. VAT

V6801-65, EAN 4047728067683

Cup brush

- Heavy brushing on large surfaces as well as for deburring, derusting and cleaning
- Steel wire
- Design with knotted wire
- 65 mm Ø
- Thread: M 14x2.0
- Maximum 12500 rpm

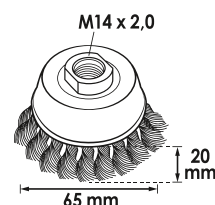

9.49 €
excl. VAT

V6804, EAN 4047728067690

Wheel brush

- Deburring, paint removal, rust removal and cleaning
- Hardened steel wire
- Design with knotted wire
- 115 mm Ø
- Thread: M 14x2.0
- Maximum 12500 rpm

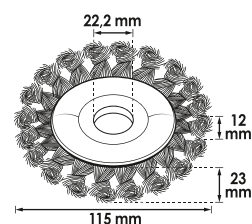

11.97 €
excl. VAT

V6805, EAN 4047728067706

Bevel brush

- Cone-shaped for hard-to-reach areas
- Hardened steel wire
- Design with knotted wire
- 100 mm Ø
- Thread: M 14x2.0
- Maximum 12500 rpm

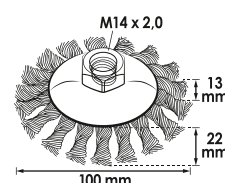

9.92 €
excl. VAT

V2626, EAN 4047728026260

Tube cutter

- For tubes made of copper, brass, light metal and PVC rigid

Ø 3 – 16 mm



14.34 €
excl. VAT

V3309, EAN 4047728033091

Ratcheting tube cutter for exhaust pipe

- For cutting stainless steel, steel, copper and aluminium
- Ratchet function:
 - allows you to work in areas with restricted access
 - means it is not necessary to guide the cutting handle pipe
- Working range: 32 – 67 mm
- Cutting depth: 3 mm



167.- €
excl. VAT

V3451, EAN 4047728034517

Spare blades

- Spare blades for ratcheting exhaust pipe cutter V3309



9.16 €
excl. VAT

V1707, EAN 4047728017077

HSS step drill set



VIGOR No.	Ø mm	L mm	EAN 4047728+	€
V2394	4-12	65	023948	22.85
V2395	4-20	75	023955	29.75
V2396	4-30	100	023962	80.85

124.- €
excl. VAT



vigor_equipment_official





Torque tools

Torque wrenches

236

Rotation angle tester

237



Torque wrench

- Torque release: palpable and audible
- Release accuracy tolerance $\pm 4\%$ of scale value (in direction of actuation)
- With serial number and certificate
- DIN EN ISO 6789-2:2017, DIN 3120, ISO 1174-1A
- 72 teeth
- 5° Opening angle

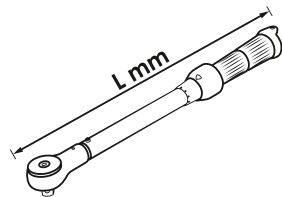

12.5 1/2 72 5°

VIGOR No.	Nm	mm	Tolerance	EAN 4047728+	€
V3898	20 - 120	12.5 1/2 445	4	038980	150.-
V3441	40 - 200	12.5 1/2 540	4	034418	150.-
V3899	60 - 320	12.5 1/2 610	4	038997	171.50

Fine-tooth reversible ratchet



Scale graduation: 1 Nm



Double scale: Nm and lbf.ft.



Handle with suspension lug



Rotation angle tester



V2795, EAN 4047728027953

Rotation angle tester

- Fine resolution (0.1°)
- Rotation angle range up to 999° (adding)
- Angle measurement in clockwise and anti-clockwise direction
- Memory capacity up to 99 readings
- Indication of battery charge
- LED alarm indication (flashing)
- Buzzer alarm indication
- Audible alarm signal
- Automatic switch-off function



167.-€
excl. VAT





Pneumatic tools

Impact wrenches

239–240

Air ratchets

241

Die grinder

242

Sanders / Drills

243

Pneumatic air blow and body protection guns

244–245

Impact wrenches



V4800N, EAN 4047728075633

Impact wrench

- Exhaust air is guided downwards through the handle
- Cold insulated handle
- High performance twin hammer mechanism
- Ergonomically shaped handle and housing for improved handling and operation

ECO GIANT



12⁵ 1/2"



NEW



Maximum loosening torque: 1720 Nm

High performance twin hammer mechanism

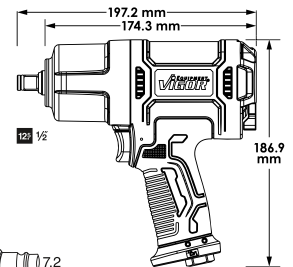

12.91 (4) 7.2

Coupler plug included

VIGOR No.	12 ⁵ 1/2"	max. Nm	Nm	Nm	1/min	L mm	kg	Ø mm	l/min	bar	dB (A)	m/s ²	EAN 4047728+	€
V4800N	12 ⁵ 1/2"	1100	850	1720	8000	202	2.3	10	198.05	6.3	94.10	7.70	075633	99.-

V5671, EAN 4047728056717

Mini impact wrench

- Compact design for areas with restricted access
- Multiple power settings in forward and reverse with one-hand adjustment
- Exhaust air is guided downwards through the handle
- Cold insulated handle
- High performance single hammer striking mechanism
- Ergonomically shaped handle and housing for improved handling and operation

MINI GIANT



12⁵ 1/2"



Maximum loosening torque: 1000 Nm

Single hammer striking mechanism



Comparison V5671 with V4800N

Multiple power settings in forward and reverse with one-hand reversing switch

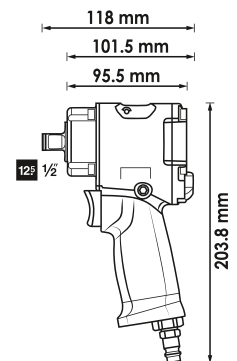

12.91 (4) 7.2

Coupler plug included

VIGOR No.	12 ⁵ 1/2"	max. Nm	Nm	Nm	1/min	L mm	kg	Ø mm	l/min	bar	dB (A)	m/s ²	EAN 4047728+	€
V5671	12 ⁵ 1/2"	610	474	1000	8500	118	1.45	10	141.5	6.3	94.6	5.99	056717	147.50



V3653, EAN 4047728036535

Impact wrench

- Multiple power settings in forward and reverse with one-hand adjustment
- Exhaust air is guided downwards through the handle
- Cold insulated handle
- High performance twin hammer mechanism
- Ergonomically shaped handle and housing for improved handling and operation

GIGA GIANT



12⁵ 1/2"



High performance twin hammer mechanism

Maximum loosening torque: 1890 Nm

Multiple power settings in forward and reverse with one-hand reversing switch

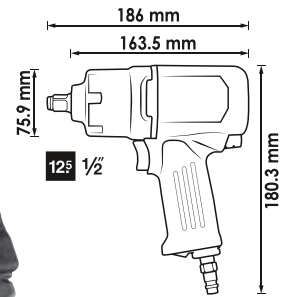

12.91 (4) 7.2

Coupler plug included

VIGOR No.	12 ⁵ 1/2"	max. Nm	Nm	Nm	1/min	mm	kg	Ø mm	l/min	bar	dB (A)	m/s ²	EAN 4047728+	€
V3653	12 ⁵ 1/2"	1290	700	1890	8500	186	1.95	10	113	6.3	96	12.92	036535	283.-

V6899, EAN 4047728068994

Impact wrench

- Multiple power settings in forward and reverse with one-hand adjustment
- Cold insulated handle
- Exhaust air is guided downwards through the handle
- High performance twin hammer mechanism
- Ergonomically shaped handle and housing for improved handling and operation

GIGA GIANT



20 3/4"



High performance twin hammer mechanism

Maximum loosening torque: 1890 Nm

Multiple power settings in forward and reverse with one-hand reversing switch

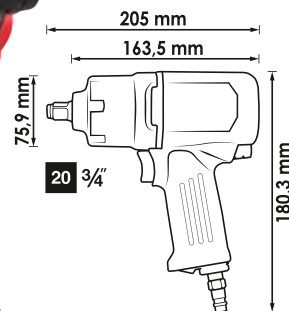

12.91 (4) 7.2

Coupler plug included

VIGOR No.	20 3/4"	max. Nm	Nm	Nm	1/min	mm	kg	Ø mm	l/min	bar	dB (A)	m/s ²	EAN 4047728+	€
V6899	20 3/4"	1290	1890	1890	8000	205	2.2	10	142	6.3	118.2	13.20	068994	305.-

Air ratchets



V5674, EAN 4047728**056748**

Air ratchet

- For areas with restricted access
- Reversing switch on ratchet head

QUICKGIANT

6.3 1/4"



VIGOR No.		max. Nm	1/min	L mm	kg	Ø mm	l/min	bar	dB (A)	m/s ²	EAN 4047728+	€
V5674	6.3 1/4"	35.2	240	236	0.6	10	77	6.3	87.5	3.47	056748	65.76

V6554, EAN 4047728**065542**

Air ratchet

- For areas with restricted access
- Reversing switch on ratchet head

QUICKGIANT

10 3/8"



VIGOR No.		max. Nm	1/min	L mm	kg	Ø mm	l/min	bar	dB (A)	m/s ²	EAN 4047728+	€
V6554	10 3/8"	35.2	240	236	0.6	10	77	6.3	87.5	3.47	065542	63.60

V5675, EAN 4047728**056755**

Air ratchet

- For areas with restricted access
- Reversing switch on ratchet head

QUICKGIANT

12.5 1/2"



VIGOR No.		max. Nm	1/min	L mm	kg	Ø mm	l/min	bar	dB (A)	m/s ²	EAN 4047728+	€
V5675	12.5 1/2"	67	160	308.5	1.2	10	114	6.3	100.5	3.47	056755	91.63



V5672, EAN 4047728056724

Die grinder · straight design

- Cutter, cutting wheels, grinding pads with 3 and 6 mm collet chuck



Including Ø 3 mm collet chuck Including Ø 6 mm collet chuck

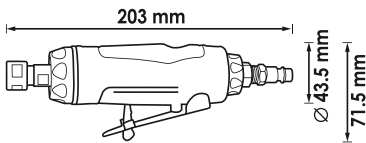

12.91 (w) 7.2

Coupler plug included



VIGOR No.	mm	1/min	mm	W Watt	kg	Ø mm	l/min	bar	dB (A)	m/s ²	EAN 4047728+	€
V5672	3-6 mm	22000	203	350	0.54	10	128.2	6.3	97.1	2.90	056724	53.90

V5673, EAN 4047728056731

Die grinder · angled

- Cutter, cutting wheels, grinding pads with 3 and 6 mm collet chuck



Including Ø 3 mm collet chuck Including Ø 6 mm collet chuck

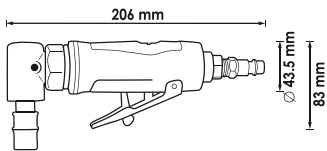

12.91 (w) 7.2

Coupler plug included



VIGOR No.	mm	1/min	mm	W Watt	kg	Ø mm	l/min	bar	dB (A)	EAN 4047728+	€
V5673	3-6 mm	20000	206	250	0.45	10	85.5	6.3	101.6	056731	79.77

V6906, EAN 4047728069069

Die grinder set · mini

- Straight design
- Small design for areas with restricted access
- For grinding, polishing or deburring
- Including collet chuck for 3 and 6 mm sockets
- Exhaust air is guided downwards through the handle
- Including 10-piece grindstone set V6906-10

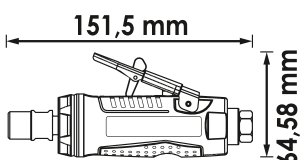

V6906-10, EAN 4047728069571

Grindstone set

- Grinding stones for VIGOR die grinders V6906 · V5672 · V5673



11.-€

VIGOR No.	mm	1/min	W Watt	kg	Ø mm	l/min	bar	dB (A)	EAN 4047728+	€
V6906	3-6 mm	25000	185	0.31	10	85	6.3	102	069069	50.13

V6903, EAN 4047728069038

Angle grinder

- Angled version for working in tight spaces
- Robust, practical design
- Universally suitable for processing a wide variety of materials
- Adjustable protection plate reduces flying sparks and catches material residues
- Exhaust air is guided downwards through the handle
- For cut-off wheels V6811-76 (76x1.6x10 mm)



RAZEGIANT

12.91 (€) 7.2

Coupler plug included

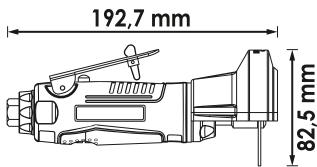

VIGOR No.	mm	1/min	mm	W Watt	Ø mm	l/min	bar	dB (A)	EAN 4047728+	€
V6903	10 mm	18000	192.7	245	10	128	6.3	90.4	069038	64.68

V6904, EAN 4047728069045

Drilling machine

- Quick-action drill chuck
- Exhaust air is guided downwards through the handle
- One-hand operation with ergonomic handle
- Lighter and more compact than conventional or cord-type drilling machines



DRILLGIANT

Ø 1-10 mm



12.91 (€) 7.2

Coupler plug included

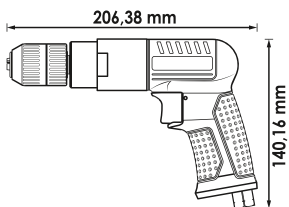

VIGOR No.	mm	1/min	mm	W Watt	kg	Ø mm	l/min	bar	dB (A)	EAN 4047728+	€
V6904	1-10 mm	1800	206	245	1	10	114	6.3	103	069045	72.23

V6905, EAN 4047728069052

Tyre inflator

- One-hand operation with ergonomic handle
- Rubber-coated manometer for protecting against small impacts
- Easily legible precision manometer with bar and PSI display
- Graduation: 0.1 bar
- Easily adjustable filling lever and discharge button, easy to reach on the handle
- Discharge button for levelling the filling capacity



FILLGIANT

18.33 €
excl. VAT

Extra long hose:
500 mm

12.91 (€) 7.2

Coupler plug included

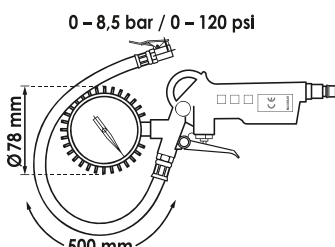

V7135, EAN 4047728071352

Air blow gun · short

- Fast removal and cleaning of chips and other foreign objects
- Long-life aluminium housing
- Suspension device incorporated

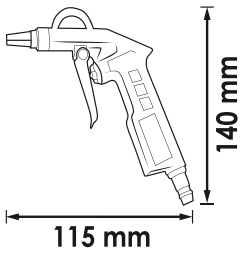

10.67 €
excl. VAT



V7135-150, EAN 4047728071369

Air blow gun · long

- Fast removal and cleaning of chips and other foreign objects
- Long-life aluminium housing
- Suspension device incorporated

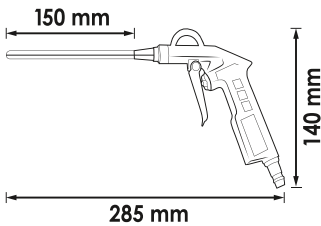
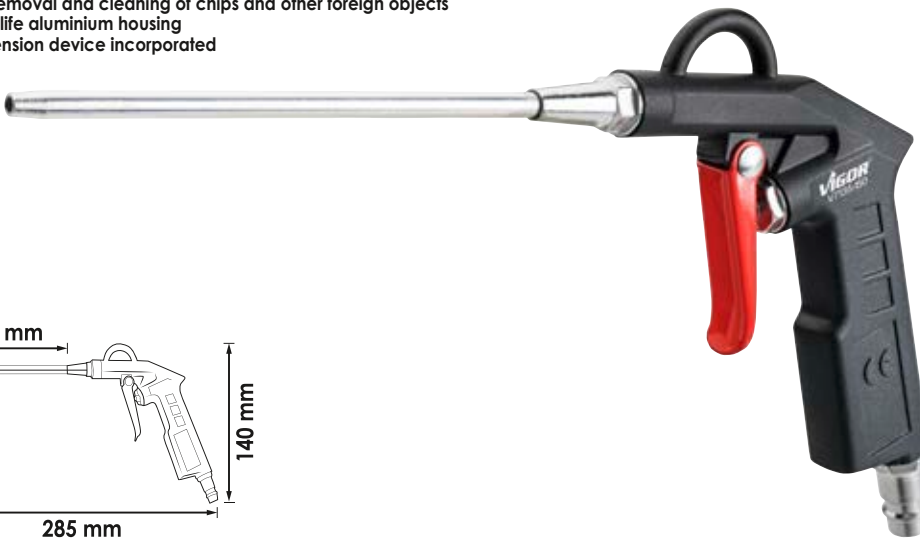

13.91 €
excl. VAT



V7143-10, EAN 4047728071437

Hose reel

- Reduces danger of accident, as there is no hose lying around
- Compact housing including opening flap for the removal of dirt or to straighten the hose
- Wall holder: 180° pivotable
- Automatic roll up through guided feed
- Pneumatic adapter pre-installed
- Hybrid polymer hose
- Auto stop function
- Impact-resistant polypropylene housing
- Adapted pull-in force
- Maximum working pressure: 12 bar

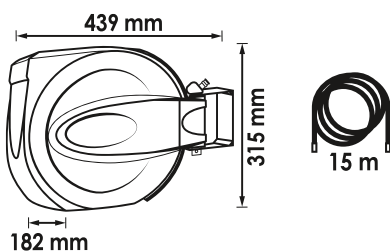

106.50 €
excl. VAT



V4322, EAN 4047728043229

Underbody protection gun

- Can be used with all common cartridges of 1000 ml
- The flexible 500 mm hose supplied with nozzle for spreading wax allows for an effortless application of wax in hollow spaces
- Simple application of the underbody protection (or noise protection) with nozzle installed as standard
- Application recommendation: Open cartridge, insert suction tube, tighten cartridge. Ready for use!



NEW



33.50 €
excl. VAT

V6907, EAN 4047728075497

Mini grease gun

- Grease tube can be changed quickly due to the screw thread
- Feed rate: 0.45 ml/stroke
- Lubricating nipple in 30° and 90° designs
- Inside thread M15x1.5



NEW



22.40 €
excl. VAT

V6907-1, EAN 4047728075503

High performance lubricant

- Grease for striking mechanisms, spindles and screw connections
- Replacement grease tube for V6907
- Corrosion protection thanks to good adhesion on metallic surfaces
- Filling capacity: 100 ml
- Outside thread: M 15x1.5



NEW

6.90 €
excl. VAT





**General
Workshop Tools**

V4241, EAN 4047728**042413**

Control cabinet key Sub Maker Quadro 10-in-1

- For almost all standard locking systems in plumbing, heating, construction, ventilation, air conditioning etc.

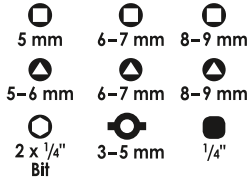

MADE IN GERMANY

26.²⁰ €
excl. VAT

V4228, EAN 4047728**042284**

Site key MasterKey construction

- For standard locking systems in plumbing, heating, construction, ventilation, air conditioning etc.
- Square mandrel allows the lock follower to be operated without a door handle or square pin

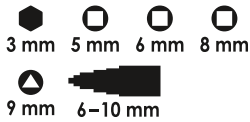

MADE IN GERMANY

Zinc pressure casting

17.²⁵ €
excl. VAT

V4227, EAN 4047728**042277**

Site key MasterKey electronics

- For almost all standard locking systems in plumbing, electronics, heating, ventilation, air conditioning etc.

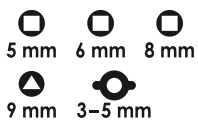

MADE IN GERMANY

Zinc pressure casting

17.⁷⁹ €
excl. VAT



V4279, EAN 4047728**042796**

Set of Japan spatulas · metal

- Applying material or smoothing surfaces, as well as for use in several other application fields
- Width of spatula 50 · 80 · 100 · 120 mm

MADE IN GERMANY



Made from highly flexible spring steel strip



7.22 €
excl. VAT

V4278, EAN 4047728**042789**

Set of Japan spatulas · plastic

- Applying material or smoothing surfaces, as well as for use in several other application fields
- For work on the body, e.g. filling holes and dents as well as several other application fields
- Width of spatula 50 · 80 · 100 · 120 mm

MADE IN GERMANY



7.22 €
excl. VAT

V5480, EAN 4047728**054799**

Telescopic inspection mirror set

- Visual inspection in areas with restricted access
- Double joint with tension spring for a view of hard to reach areas
- Replaceable mirror thanks to quick change system with 6.3 mm socket

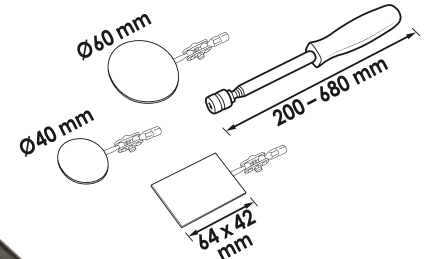

Mirror changeable using quick-change system



Quick identification of e.g. oil loss, corrosion or cable connections

57.13 €
excl. VAT

V1740, EAN 4047728068673

Magnetic pick-up tool · semi-flexible

- Retractable magnet enables selective attachment
- High-quality plastic handle
- Semi-flexible shank



28.57 €
excl. VAT

V1741, EAN 4047728017411

Telescope magnetic pick-up tool

- Picking up parts containing iron even in inaccessible parts
- Telescoping
- Practical bag clip



12.83 €
excl. VAT

V1764, EAN 4047728017640

Pick-up tool with claws and magnet · flexible

- For picking up small parts such as screws, nuts, etc. at inaccessible places
- With magnet for additional grip
- Gripping and magnetic function



20.37 €
excl. VAT

V1438, EAN 4047728014380

Tweezers set

- Ideal for working e.g. in hard-to-reach areas
- Easy grip
- Stainless steel



11.- €
excl. VAT

V5512, EAN 4047728055123

Gas soldering iron set

- Soldering, melting, shrinking and hot cutting work with seven different adapters
- Flexible, stand-alone use due to gas operation
- Device combines three functions into one:
 - Soldering iron, maximum temperature: 450 °C
 - Burner, maximum temperature: 1300 °C
 - Hot air blower, maximum temperature: 600 °C
- Small and easy to handle for working directly on the vehicle, for example
- Continuous gas regulation for optimum adaptation to the work to be carried out and the material
- Flame temperature maximum: 1300 °C
- Stand for stationary working conditions
- Piezo ignition
- Filling with commercial lighter / ISO butane gas
- Content:
 - Gas soldering iron
 - Soldering tip 3.5 mm
 - Soldering tip 4.5 mm
 - Heat-shrink tubing extension
 - Cutting tip
 - Soldering sponge protection cap
 - Solder wire



Improved solder tips



Fill level indicator



Gas valve



Stainless steel



Can be used flexibly everywhere with gas operation

67.91 €
excl. VAT

V5488, EAN 4047728054881

Multifunctional drain pan · 50 l

- Used as a cleaning pan, dirt pan, oil pan, disinfection pan, leakage pan, transport pan and feed pan e.g. in sanitary and heating construction, the motor vehicle industry and workshops, for hunting equipment, chemical/laboratory use, food industry/butcheries, fishing, pet supplies, horse accessories, etc.
- Alkaline-resistant and acid-resistant

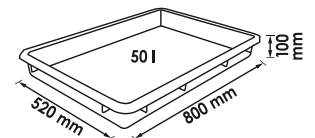

Universal application with huge capacity

62.52 €
excl. VAT

V5677, EAN 4047728056779

Magnetic cup with plastic frame

- Two strong magnets for fixing to car lifts, tool trolleys, machinery, etc.
- Setting aside small magnetic and non-magnetic parts – free hands for work
- Plastic frame offers storage space for plastic screws etc. and also serves as a catch tray
- Small parts are stored so they are clearly visible and easy to find again

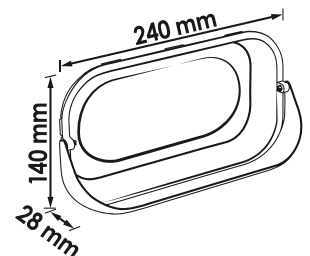

A little helper for great organisation

18.87 €
excl. VAT

V5678, EAN 4047728070539

Magnetic half shell

- Holds screws, seals or small parts
- Fixation to tool trolleys, car lifts or metal cabinets
- For the workshop, production facilities or hobby room
- Solid plastic housing with optimised magnets
- Large opening allows good view into the half shell
- Rubber housing on magnets prevents damage
- Magnetic cup magnetic on both sides – magnetic small parts adhere to back panel
- Additional stabilisation below the magnets for straight laying of the half shells
- Magnetic holding force: approx. 2.5 kg

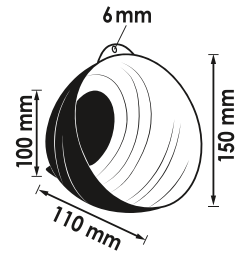

7.44 €
excl. VAT

V6468, EAN 4047728064682

Nozzle adjusting tool with magnet

- Nozzle adjustment of windscreen washing systems
- Additional function as magnetic pick-up tool
- Pocket clip



Narrow insert pin \varnothing 0.6 mm

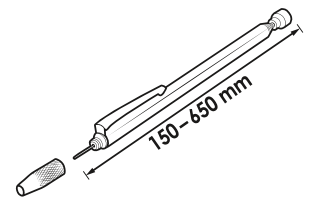

Including sales display for a purchase of at least 16 pieces

13.91 €
excl. VAT

V7221, EAN 4047728072212

Washing nozzle adjustment tool · MERCEDES-BENZ

- Damage-free adjustment of window washing system fan nozzles on MERCEDES-BENZ W204 · W207 · W212 · W218
- Optimal adjustment of window washing system fan nozzles on MERCEDES-BENZ
- Nozzle head profile with fitting accuracy
- Outside hexagon drive: 6 mm
- For the following models: W204 · W207 · W212 · W218
- Total length: 67 mm

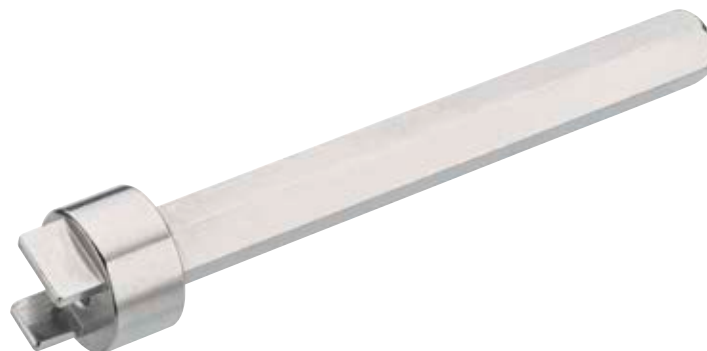

16.06 €
excl. VAT



V6742, EAN 4047728067423

Magnetic tool holer

- Storage of impact sockets, impact wrenches, torque wrenches or hoses directly on site
- Strong magnets (each with \varnothing 80 mm) guarantee a good hold on car lifts, tool trolleys or other substructures containing iron
- Magnetic holding force: approx. 20 kg



Optimal storage of impact sockets and impact wrenches directly on site

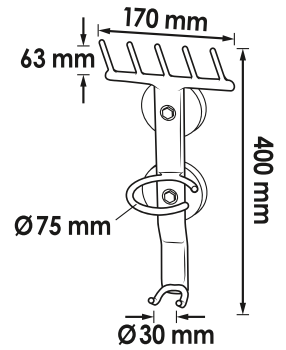

31.80 €
excl. VAT

V6605, EAN 4047728066051

Fender cover

- Protection from dents, scratches, oil and dirt
- One size fits all
- Does not cover wheels

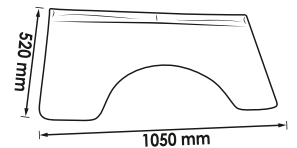

33.42 €
excl. VAT

V6606, EAN 4047728066068

Reusable seat cover

- Protection of car seat against heavy soiling
- One size fits all, for most passenger cars and common commercial vehicles
- Light nylon, PU-coated
- Water, grease and oil repellent
- Contents: 1 piece
- Washable at 40 °C



Dimensions:
L: 1350 x W: 760 mm

19.40 €
excl. VAT

Work gloves

- Assembly work in the workshop, warehouse / logistics and anywhere where secure grip and precision are important
- Light polyester woven gloves with ergonomic fit
- EN 388:2003 (3131A)



Black PU coating on the palms

VIGOR No.	Glove size	EAN 4047728+	€
V6435	9 / L	064354	1.51
V6435-XL	10 / XL	069984	1.40

V2338, EAN 4047728023382

Kneeling mat

- Comfortable working in the workshop, in industry, in the garden or in the household
- High-quality foam
- Knee-protecting
- Heat insulating
- Water and oil repellent
- With carrying handle



Comfortable and low-impact working in the workshop, in industry, in the garden or in the household

19.94 €
excl. VAT

V2338-XL, EAN 4047728071444

Mechanic's mat

- Comfortable working on the floor in the workshop, in industry, in the garden or in the household
- Large lying surface
- High-quality foam
- Low-impact
- Pliant and heat-retaining foam
- With two handles

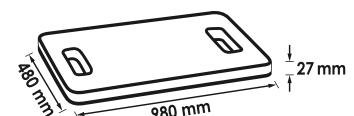

32.23 €
excl. VAT



V6973, EAN 4047728069731

Mechanic's creeper

- Padded head rest
- Two side storage compartments for screws or other small parts
- High-quality finish made of plastic
- Easy to clean
- Six castors made of hard plastic
- Loading capacity maximum 150 kg

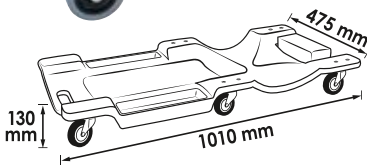

Work comfortably under vehicles

76.54 €
excl. VAT

V6973-1, EAN 4047728069748

Replacement roller for mechanic's creeper



9.49 €
excl. VAT

V2316, EAN 4047728023160

LED folding light

- Rechargeable Li-Ion battery 3.6 V
- 3.5 – 4 h
- 5 LED = 300 Lux at a distance of 60 cm
- 18 LED = 800 Lux at a distance of 60 cm
- approx. 200 g
- Height: 220 mm
- IP30

5 LED = 300 Lux
5 h Removable

18 LED = 800 Lux
1.5 h



47.32 €
excl. VAT

V2347, EAN 4047728023474

12 V charger for LED folding light V2316



6.36 €
excl. VAT

V6299, EAN 4047728062039

Non-contact infrared thermometer

- Laser for contact-free measuring in various application areas, such as in motor vehicles, industry, private households, gas, heating and air conditioning units, etc.
- Measuring range: -35 °C to +630 °C
- Universal application range
- Robust plastic housing
- Red-luminescent laser
- Automatic switch-off function
- With 9V block battery
- CE-tested



Illuminated LCD digital display



Temperature readings in seconds at the touch of a button

113.- €
excl. VAT

V4646, EAN 4047728**046466**

Brush set

- Professional cleaning and deburring of cylinders, tubes, bushings, etc.
- For drilling machines and pneumatic drills (When operating with power tools only use the brushes rotating clockwise)
 - 12 nylon brushes: Ø 8 · 9 · 10 · 11 · 12 · 13 · 14 · 15 · 16 · 17 · 18 · 19 mm
 - 12 steel brushes: Ø 8 · 9 · 10 · 11 · 12 · 13 · 14 · 15 · 16 · 17 · 18 · 19 mm
 - 12 brushes with brass coating: Ø 8 · 9 · 10 · 11 · 12 · 13 · 14 · 15 · 16 · 17 · 18 · 19 mm
 - 1 handle with adapter and quick lock
 - 1 extension 150 mm



38

55.52 €
excl. VAT

Spare parts 10 pieces per pack

VIGOR No.	Designation	EAN 4047728+	€
V4646M-8	Brass brush set Ø 8 mm	054102	16.06
V4646M-9	Brass brush set Ø 9 mm	054119	16.06
V4646M-10	Brass brush set Ø 10 mm	054126	16.06
V4646M-11	Brass brush set Ø 11 mm	054133	16.06
V4646M-12	Brass brush set Ø 12 mm	054140	16.06
V4646M-13	Brass brush set Ø 13 mm	054157	16.06
V4646M-14	Brass brush set Ø 14 mm	054164	16.06
V4646M-15	Brass brush set Ø 15 mm	054171	17.79
V4646M-16	Brass brush set Ø 16 mm	054188	17.79
V4646M-17	Brass brush set Ø 17 mm	054195	17.79
V4646M-18	Brass brush set Ø 18 mm	054201	17.79
V4646M-19	Brass brush set Ø 19 mm	054218	17.79

VIGOR No.	Designation	EAN 4047728+	€
V4646N-8	Nylon brush set Ø 8 mm	054225	14.34
V4646N-9	Nylon brush set Ø 9 mm	054232	14.34
V4646N-10	Nylon brush set Ø 10 mm	054249	14.34
V4646N-11	Nylon brush set Ø 11 mm	054256	14.34
V4646N-12	Nylon brush set Ø 12 mm	054263	14.34
V4646N-13	Nylon brush set Ø 13 mm	054270	14.34
V4646N-14	Nylon brush set Ø 14 mm	054287	14.34
V4646N-15	Nylon brush set Ø 15 mm	054294	14.34
V4646N-16	Nylon brush set Ø 16 mm	054300	14.34
V4646N-17	Nylon brush set Ø 17 mm	054317	14.34
V4646N-18	Nylon brush set Ø 18 mm	054324	14.34
V4646N-19	Nylon brush set Ø 19 mm	054331	14.34



VIGOR No.	Designation	EAN 4047728+	€
V4646S-8	Steel brush set Ø 8 mm	053587	14.34
V4646S-9	Steel brush set Ø 9 mm	053594	14.34
V4646S-10	Steel brush set Ø 10 mm	053600	14.34
V4646S-11	Steel brush set Ø 11 mm	054010	14.34
V4646S-12	Steel brush set Ø 12 mm	054027	14.34
V4646S-13	Steel brush set Ø 13 mm	054034	14.34
V4646S-14	Steel brush set Ø 14 mm	054041	14.34
V4646S-15	Steel brush set Ø 15 mm	054058	16.06
V4646S-16	Steel brush set Ø 16 mm	054065	16.06
V4646S-17	Steel brush set Ø 17 mm	054072	16.06
V4646S-18	Steel brush set Ø 18 mm	054089	16.06
V4646S-19	Steel brush set Ø 19 mm	054096	16.06

10

Flap disc set 115 mm

- High stock removal rate; allows effortless surface grinding on steel and stainless steel without smearing. Does not leave scratches on the workpiece
- Universal flap disc with long service life
- Contents: 10 pieces



VIGOR No.		Outside Ø mm	Center hole mm	Grain size	1/min	EAN 4047728+	€
V6810-115K40	10	115	22.23	40	13280	067737	26.84
V6810-115K60	10	115	22.23	60	13280	067744	26.84
V6810-115K80	10	115	22.23	80	13280	067751	26.84

Flap disc set 125 mm

- High stock removal rate; allows effortless surface grinding on steel and stainless steel without smearing. Does not leave scratches on the workpiece
- Universal flap disc with long service life
- Contents: 10 pieces



VIGOR No.		Outside Ø mm	Center hole mm	Grain size	1/min	EAN 4047728+	€
V6810-125K40	10	125	22.23	40	12200	067782	27.92
V6810-125K60	10	125	22.23	60	12200	067775	27.92
V7010-125K80	10	125	22.23	80	12200	070690	27.92

Cut-off wheel set

- Handheld cut-off wheels for stainless steel and steel for thin sheet metal (e.g. car body), steel cables, profiles, tubes, non-ferrous metals and high-temperature-resistant materials
- Particularly sharp disc with good service life



VIGOR No.		Outside Ø mm	Center hole mm	Thickness [mm]	1/min	EAN 4047728+	€
V6811-76	25	76	22.23	1.6	20100	070287	44.20
V6811-115	10	115	22.23	1	13280	067287	11.-
V6811-125	10	125	22.23	1	12200	067768	12.18

V7106, EAN 4047728071062

Window pane holder · single

- For carrying, raising and holding panes, wooden boards and mirrors etc.
- Suction cup adapts to smooth, dust-free surfaces
- Release lever for simple operation
- Hold by vacuum build-up of the suction cups
- Sturdy design made of aluminium
- Loading capacity maximum: 50 kg

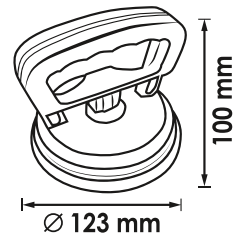

16.06 €
excl. VAT

V7107, EAN 4047728071079

Window pane holder · double

- For carrying, raising and holding panes, wooden boards and mirrors etc.
- Suction cup adapts to smooth, dust-free surfaces
- Release lever for simple operation
- Hold by vacuum build-up of the suction cups
- Sturdy design made of aluminium
- Loading capacity maximum: 100 kg

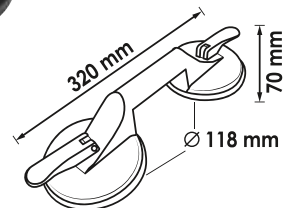

32.23 €
excl. VAT

V5531, EAN 4047728055314

Single-hand mini window pane holder

- For lifting, carrying and holding
- Adjusting and setting mirror glass
- One-hand operation using lever
- Loading capacity maximum: 8 kg

With release button

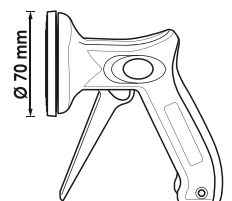

19.40 €
excl. VAT



Outside deburrer

- For deburring screws and threads and for adjusting deformed drive shafts, steering tie rods or stud bolts on wheel hubs
- Hexagon drive, 6.3 mm
- Rotation speed: 0 – 500 rpm
- Cutting plates made of high-strength tungsten steel
- Suitable for the following materials:
 - Stainless steel
 - Steel
 - Brass
 - Non-ferrous metal
 - Plastics

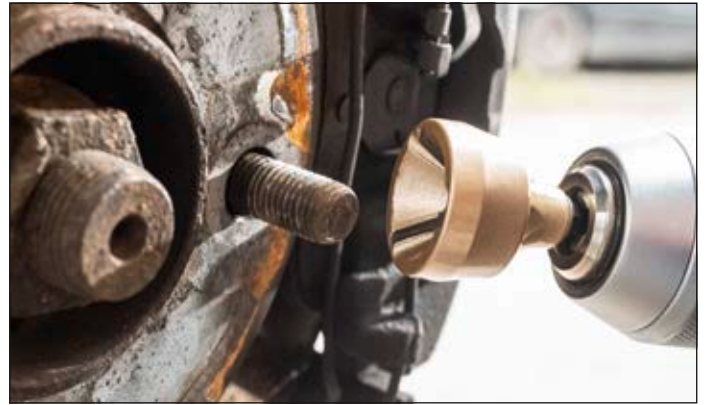

V7402

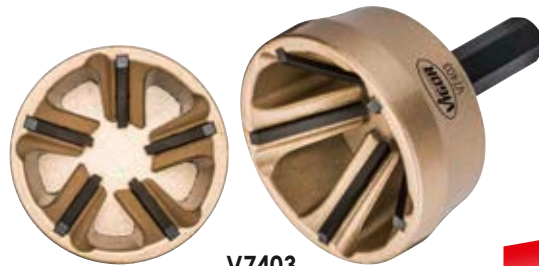

V7403

NEW



VIGOR No.	∅ mm	EAN 4047728+	€
V7402	3-19	074025	49.80
V7403	13-35	074032	86.02

V4638, EAN 4047728046381

Safety platform · aluminium

- Lightweight
- Safety locking on both feet
- Maximum loading capacity: 150 kg
- Weight: 7.2 kg



Space saving collapsible

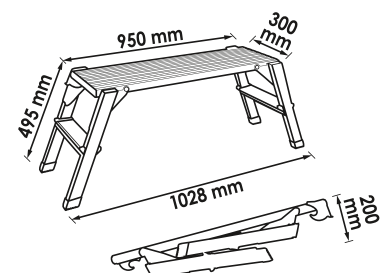

147.50 €
excl. VAT





Diagnostics / Battery / Electrical System

Electrical system	261, 264
Multimeter	261
Cable release tools	262
Crimping pliers set	263

Electrical system Multimeter



V4324, EAN 4047728043243

Digital multimeter

- Compact and practical
- High-contrast, one-line LCD display including backlighting
- 19-position rotary switch
- Reliable warning thanks to automatic overflow and polarity display for preventing possible errors
- Stand-up positioning including protective rubber cover
- Measuring cable with protection against contact
- DC: 200 mV – 600 V
- AC: 200 V – 600 V
- DC: 200 mA – 10 A
- Resistance: 200–2000 Ohm
- Diode tester
- Maximum display: 1999
- 9 V battery (in device)
- Fuses:
 - 1 x 250 mA / 250 V
 - 1 x 10 A / 250 V
- Multimeter for testing quiescent current
- Used with measuring cable set V4326
- Functions:
 - Direct and alternating current measurements
 - Direct and alternating current measurement
 - Resistance measurement
 - Diode test (with acoustic signal)
 - Passage inspection (with acoustic signal)
 - Data hold function



VIGOR No.	Designation	EAN 4047728+	€
V4324-1	Fuses · 5 pieces	053532	4.10
V4324-2	Measuring cable for V4324	053549	6.04

33.42 €
excl. VAT

V1722, EAN 4047728017220

Car light tester

∠ 6 – 24 V

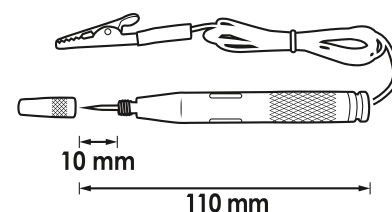

8.52 €
excl. VAT

V4451, EAN 4047728044516

SYSTEM cable release tool set

- Damage-free release of electrical plugs and connectors e.g. with ABS, air conditioning sensors, radio, PDC, trailer coupling modules, etc.
- Fast trouble-shooting with corrosion or connection defects
- For round and flat connectors



VIGOR No.	Designation	Design	EAN 4047728+	€
V4451-1	Individual SYSTEM cable release tool 1 · BMW · MERCEDES-BENZ · OPEL/VAUXHALL · VW/AUDI		053693	13.69
V4451-2	Individual SYSTEM cable release tool 2 · BMW · JAGUAR · MERCEDES-BENZ · PORSCHE · SAAB · SEAT · ŠKODA		053709	13.69
V4451-3	Individual SYSTEM cable release tool 3 · BMW · MERCEDES-BENZ · OPEL/VAUXHALL · PORSCHE · VW/AUDI		053716	13.69
V4451-4	Individual SYSTEM cable release tool 4 · FORD		053723	9.81
V4451-5	Individual SYSTEM cable release tool 5 · BMW · FORD · MERCEDES-BENZ · OPEL/VAUXHALL · PORSCHE · SEAT · ŠKODA · VW/AUDI		053730	9.81
V4451-6	Individual SYSTEM cable release tool 6 · BMW · FORD · JAGUAR · OPEL/VAUXHALL · MERCEDES-BENZ · PORSCHE · SAAB · SEAT · ŠKODA · VW/AUDI		053747	9.81
V4451-7	Individual SYSTEM cable release tool 7 · MERCEDES BENZ		053754	9.81
V4451-8	Individual SYSTEM cable release tool 8 · FORD · JAGUAR · MERCEDES-BENZ · OPEL/VAUXHALL · PORSCHE · VW/AUDI		053761	9.81
V4451-9	Individual SYSTEM cable release tool 9 · FORD · MERCEDES BENZ		053815	9.81
V4451-10	Individual SYSTEM cable release tool 10 · MERCEDES BENZ		053822	9.81
V4451-11	Individual SYSTEM cable release tool 11 · BMW · FORD · JAGUAR · MERCEDES-BENZ · OPEL/VAUXHALL · PORSCHE · SAAB · SEAT · ŠKODA · VW/AUDI		053839	9.81
V4451-12	Individual SYSTEM cable release tool 12 · OPEL/VAUXHALL · RENAULT · ŠKODA · VW/AUDI		053846	9.81
V4451-13	Individual SYSTEM cable release tool 13 · FORD · MERCEDES BENZ		053853	9.81
V4451-14	Individual SYSTEM cable release tool 14 · FORD · JAGUAR · PORSCHE		053860	9.81
V4451-15	Individual SYSTEM cable release tool 15 · BMW · FORD · MERCEDES-BENZ · OPEL/VAUXHALL · SEAT · ŠKODA · VW/AUDI		053877	9.81
V4451-16	Individual SYSTEM cable release tool 16 · BMW · FORD · JAGUAR · MERCEDES-BENZ · OPEL/VAUXHALL · PORSCHE · VW/AUDI		053884	9.81
V4451-17	Individual SYSTEM cable release tool 17 · BMW		053891	9.81
V4451-18	Individual SYSTEM cable release tool 18 · MERCEDES BENZ		053907	9.81
V4451-19	Individual SYSTEM cable release tool 19 · CITROËN · FIAT · CHRYSLER · FORD · HONDA · MAZDA · OPEL/VAUXHALL · MERCEDES-BENZ · MITSUBISHI · PORSCHE · RENAULT · SEAT · TOYOTA · VW/AUDI		053914	9.81
V4451-20	Individual SYSTEM cable release tool 20 · FORD		053921	9.81
V4451-21	Individual SYSTEM cable release tool 21 · BMW · FORD · JAGUAR · MERCEDES-BENZ · OPEL/VAUXHALL · PORSCHE · SAAB · SEAT · ŠKODA · VW/AUDI		053938	9.81
V4451-22	Individual SYSTEM cable release tool 22 · HONDA · OPEL/VAUXHALL · TOYOTA · VW/AUDI		053945	9.81
V4451-23	Individual SYSTEM cable release tool 23 · OPEL/VAUXHALL · VW/AUDI		053952	9.81

*Indispensable
for mechatronics
technicians and motor
vehicle electricians*

214.50 €
excl. VAT



Crimping pliers set



V2499, EAN 4047728024990

Crimping pliers set

- Five replaceable crimping sockets:
- Crimping socket A: for insulated cable lugs from 0.5 – 6.0 mm² (red, blue, yellow)
- Crimping socket B: for closed, non-insulated cable lugs of 1.5 · 2.5 · 6.0 · 10 mm²
- Crimping socket C: for open, non-insulated cable lugs from 0.5 – 6.0 mm² (width up to 6.3 mm)
- Crimping socket D: for wire end sleeves with or without collar from 0.5 – 4.0 mm²
- Crimping socket F: for wire end sleeves above 6.0 mm²



With locking lever

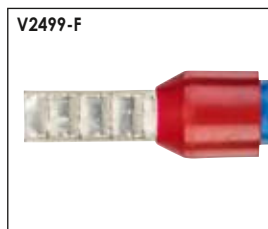
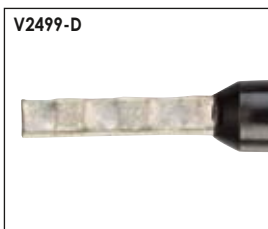
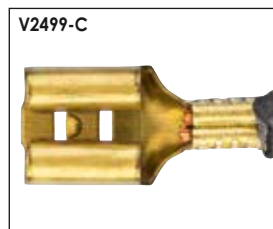
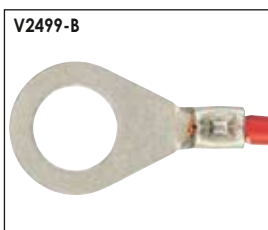

147.50 €
excl. VAT

Spare parts

VIGOR No.	Designation	Design	EAN 4047728+	€
V2499-A	Crimping socket A: for insulated cable lugs from 0.5 – 6.0 mm ² (red · blue · yellow)		053440	28.89
V2499-B	Crimping socket B: for closed · non-insulated cable lugs of 1.5 · 2.5 · 6.0 · 10 mm ²		053457	28.89
V2499-C	Crimping socket C: for open · non-insulated cable lugs of 0.5 – 6.0 mm ² (width up to 6.3 mm)		053464	28.89
V2499-D	Crimping socket D: for wire end sleeves with or without collar from 0.5 – 4.0 mm ²		053471	28.89
V2499-F	Crimping socket F: for wire end sleeves above 6.0 mm ²		053488	28.89

V2499-A, EAN 4047728053440

Crimping jaws



28.89 €
excl. VAT

V7548, EAN 4047728075480

Battery

- Checking the status of battery and charging systems (12- and 24 V)
- Suitable for start-stop batteries
- For passenger cars, motorcycles, vans and boats
- Functions:
 - Status report of the battery and charging systems
 - Debit note when starting up the motor
 - Identification of defective batteries
 - Option to print the test results
- Mobile use, without power supply
- Makes it possible to check when fitted or removed
- User-friendly operation
- Reverse polarity protection prevents short circuit
- Thermal paper castor included in delivery
- Clamping cable length: 600 mm



NEW

220.- €
excl. VAT



V7548-1, EAN 4047728075527

Thermal paper castor

- Width: 56 mm
- Linear length: 5 m
- Diameter: 29 mm
- Sleeve diameter: 15 mm



7.50 €
excl. VAT





You will always find what
you're looking for here!

The new VIGOR spare parts shop

www.vigor-equipment.com

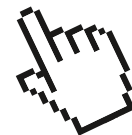
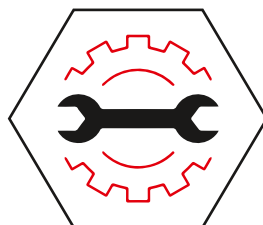

Engine / Radiator / A/C

Engine tools

267–269

Cooling system diagnostics

270–272

Turbo system diagnostics

273–274

Compression and pressure loss testers

275–276



STORAGE

STORAGE

V5676, EAN 4047728056762

Oxygen sensor set

- Oxygen sensors, injection nozzles as well as thermal circuit-breakers in hard to reach areas

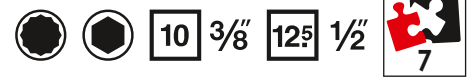

85.16 €
excl. VAT

● 22 mm

10 3/8



● 22 mm

10 3/8



● 27 mm

10 3/8



● 22 mm

125 1/2



● 29 mm

125 1/2



○ 27 mm

125 1/2



● 22 mm

10 3/8



V6741, EAN 4047728**067416**

Extractor set for ignition coils

- Professional and damage-free removal of ignition coils and ignition coil strips on VAG and OPEL/VAUXHALL engines
- Attaching and then removing enables an even disassembly of the ignition module
- Recommended use in pairs
- Greatest market coverage
- 2 ignition module pullers for:
 - CHEVROLET/GMC Aveo Cruze · OPEL/VAUXHALL Adam · Agila B · Astra J · Cascada Combo · Corsa D · Meriva B · Mokka · Zafira Tourer
 - Engines:
 - 1 litre A10XEP (LDB), 1.2: A12XEL (LWD) A12XER (LDC), 1.4: A14XEL (L2Z) A14XER (LDD) LDU
 - 1.4 litres (T) A14NEL (LUH) A14NET (LUJ) Twinport / ecoFLEX engines
 - OPEL 3 or 4-cylinder petrol injection engines e.g. in Agila A · Astra F · Astra G · Astra H · Astra J · Calibra Combo · Corsa B · Corsa C · Corsa D · Frontera A · Frontera B · Insignia · Meriva A · Meriva B · Omega B · Signum · Tigra A · Tigra B · Vectra B · Vectra C · Zafira A · Zafira B
 - Engine codes: 20LEH · 2HO · A10XEP · A14NEL · A14NET · A14XER · A16LET · A16XER · A18XER · C22SEL · LDD · LDE · LLU · LUH · LUJ · X14NZ · X14SZ · X14XE · X16SZR · X16XE · X16XEL · X18XE · X20SE · X20XEV · X22SE · X22XE · Y22SE · Z10XEP · Z12XE · Z12XEP · Z14XE · Z14XEL · Z14XEP · Z16LEL · Z16LER · Z16LET · Z16XE · Z16XER · Z16YNG · Z18XE · Z18XER · Z20LER
- 4 ignition claws:
 - TYPE A (26 mm): e.g. VW Golf · Bora · Beetle · Lupo · Passat · Touran · T4 · AUDI A2
 - TYPE B (18 mm): Bora · Golf · Passat · Sharan · Touareg · Phaeton · T5
 - TYPE C (43 mm): 8 and 12-cylinder engines such as Phaeton, among others
 - TYPE D (35 mm): Direct injection engine VW Golf · Touran · Passat and Eos as well as AUDI A4 and A6



71.15 €
excl. VAT



V3381, EAN 4047728033817

Hose clamp set

- For hoses with Ø up to 45 mm



29.11 €
excl. VAT

V3571, EAN 4047728035712

V-ribbed belt tool

- Fibre-glass reinforced nylon
- Most easy-to-use tool on the market
- No adjustment necessary
- For all flexible belts: air-conditioning systems, generators, and single/double pulleys



Installation



Removal



44.74 €
excl. VAT

V1963N, EAN 4047728060097

Cooling system diagnosis set

- Passenger car diagnostics
- Complete set for service work on cooling and heating system
- Comprehensive range of adapters, for vehicles with water-cooled engines
- 3 features: pressure test (check for leaks in radiator system) · refilling · cleaning
- Control of pressure loss via manometer
- Filling creates a vacuum in the radiator system (Advantage: coolant is sucked in without air bubbles)
- Enables refilling of even large engines without thermal influences
- Universal usage due to conical rubber radiator adapter
- Measuring range: 0 – 2.5 bar
- Including 90° adapter for hard-to-reach places



430.- €
excl. VAT

Greatest market coverage, 29 pieces



Cooling system diagnostics



VIGOR No.	Designation	Design	EAN 4047728+	€
V1963-1	Filling hose cooling fluid including connection		053228	16.60
V1963-3	Test adapter black R123 · R124		053242	15.52
V1963-4	Test adapter blue R123 · R125		053259	22.10
V1963-5	Bayonet adapter 3 · large		053266	25.55
V1963-6	Bayonet adapter 4 · medium		053273	25.55
V1963-7	Bayonet adapter 5 · small		053280	25.55
V1963-8	Adapter · M 42x2.5		053297	15.52
V1963-9	Adapter · M 42x3.0		053303	15.52
V1963-10	Adapter · M 45x3.0, hollow		053310	15.52
V1963-11	Adapter · M 46x3.0		053327	15.52
V1963-12	Adapter · M 48x2.5		053334	15.52
V1963-13	Adapter · M 48x4.0		053341	15.52
V1963-14	Adapter · M 50x2.5		053358	15.52
V1963-15	Adapter · M 50x2.5, hollow		053365	15.52

VIGOR No.	Designation	Design	EAN 4047728+	€
V1963-16	Adapter · M 50x3.0		053372	15.52
V1963-17	Adapter · M 52x3.0		053389	15.52
V1963-18	Adapter · M 60x4.0		053396	15.52
V1963-19	Adapter · M 34x3.0		053402	15.52
V1963-20	Adapter · M 58x3.0		053419	15.52
V1963-21	Adapter · M 62x3.0		053426	15.52
V1963-22	Thermometer		053433	18.87
V1963-23	Adapter · M 45x3.0		060103	29.43
V1963-24	Adapter 90°		060110	29.43
V1963-25	Universal adapter / tapered head		060127	15.52
V4257	Cooling system screw adapter · M 45x3.0 mm		042574	15.52
V4202	Vacuum filling unit		042024	99.18
V4258	Cooling system screw adapter · M 52.5x3.0 mm		042581	15.52
V3729	Hand pump with manometer		037297	94.86

V5660, EAN 4047728056601

Clutch from 4.4 mm to 7.2 mm

- Adaptation of hand pump V3729 with products from other manufacturers, e.g. Klann adapters / systems (4.4 mm to 7.2 mm)



22.85 €
excl. VAT

V5922, EAN 4047728059220

Clutch from 7.2 mm to 4.4 mm

- Adaptation of VIGOR cooling system adapter with e.g. Klann hand pumps / systems (7.2 mm to 4.4 mm)



22.85 €
excl. VAT

V2459N, EAN 4047728075541

Refractometer

- Fast, precise control of the anti-freeze concentration on coolant and screenwash as well as for checking the battery acid density and AdBlue
- Eyepiece with adjustable focus, equipped with rubber cup
- Left scale: battery acid density measuring range 1100 – 1400 sg / resolution 0.01 sg
- Middle scale: antifreeze based on propylene glycol G 13, measuring range 0 °C to -50 °C / resolution 5° C, and antifreeze based on ethylene glycol G 11/G 12, measuring range 0 °C to -50 °C / resolution 5 °C
- Upper right scale: AdBlue (VRA) urea concentration, measuring range 30% – 35% / resolution 0.1%
- Lower right scale: screenwash antifreeze SRF 1, measuring range 10 °C to -40 °C / resolution 1 °C
- Plastic case with soft foam insert
- Contents:
 - 1 x refractometer
 - 1 x pipette



NEW



Application e.g. for coolant, screenwash, battery fluid and AdBlue

66.- €
excl. VAT

V1586, EAN 4047728015868

Anti-freeze tester

- For testing ethylene glycol coolant (anti-freeze) in passenger cars, trucks, etc.



21.02 €
excl. VAT

Turbo system diagnostics



V4192, EAN 4047728041928

Turbo system pressure tester set for click systems

- Quick diagnosis of charging air systems in new generations of vehicles in which air pipes are connected with click systems
- Performing leak tests using noise generation, leak detector spray or pressure drop
- Contents: 6 plug pairs 31 · 38 · 46 · 51 · 56 · 61 mm



Enables time saving and appropriate determination of leaking charging air hoses



221.- €
excl. VAT

V4233, EAN 4047728042338

Manometer for turbo system pressure tester kit

For V3595 · V4192 and V4331



57.13 €
excl. VAT



V4304, EAN 4047728**043045**

Turbo system pressure tester kit for motor vehicles

- Fast diagnostics of the charging air system
- Proper, time-saving identification of leaky charge-air coolers and invisible cracks in charging air hoses
- Contents:
1 pressure hose with manometer and equalization valve
6 pairs of stepped adapters:
31/38 · 46/51 · 55/60 · 65/70 · 75/80 · 85/90 mm



Including manometer



279.- €
excl. VAT

V4305, EAN 4047728**043052**

Adapter 31/38 mm

- Use with manometer V4233 for testing the turbo system
- For example as an extension to the turbo system pressure tester kit V3595



41.18 €
excl. VAT

V4306, EAN 4047728**043069**

Adapter 46/51 mm

- Use with manometer V4233 for testing the turbo system
- For example as an extension to the turbo system pressure tester kit V3595



41.18 €
excl. VAT

V4461, EAN 4047728044615

Compression and pressure loss tester set

- Professional testing of compression and pressure loss for the engines of most of passenger cars, trucks, motorcycles, buses, agricultural vehicles and boats as well as Hdi, TDCi and pump injector engines
- For diesel and petrol engines
- Contains glow plug adapter for e.g.: ALFA ROMEO · BMW · CHRYSLER · DAEWOO · FIAT · FORD · HYUNDAI · ISUZU · LAND ROVER · MAZDA · MERCEDES-BENZ · MITSUBISHI · NISSAN · OPEL · PSA · RENAULT · SAAB · SUZUKI · TOYOTA · VAG · VAUXHALL · Volvo · etc.
- Glow plug adapter M 10 · M 12 · M 14 · M 18
- Compression pressure gauge maximum 50 bar
- Quick coupler in straight and angled design
- Injector nozzle adapter M 20 · M 22 · M 24 and for FORD Stanadyne injectors



For diesel and petrol engines

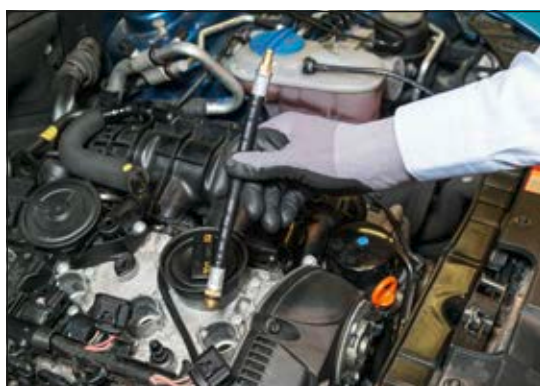

744.- €
excl. VAT



V4325, EAN 4047728043250

Vacuum and pressure pump set

- Testing pressure and underpressure systems
- Charging pressure
- Vacuum solenoids
- MAP sensors
- Tank aerations
- Brake line systems
- Including extensive assortment of adapters



188.50 €
excl. VAT

*Also suitable for
brake line systems*



Hose length: 630 m



Robust metal design

Filling capacity:
120 ml

Display range: -1 to 4 bar
Underpressure indicator range: from -1 to 0 bar
Maximum pressure: up to 3 bar
Maximum underpressure: up to 0.7 bar



Follow us on

Instagram

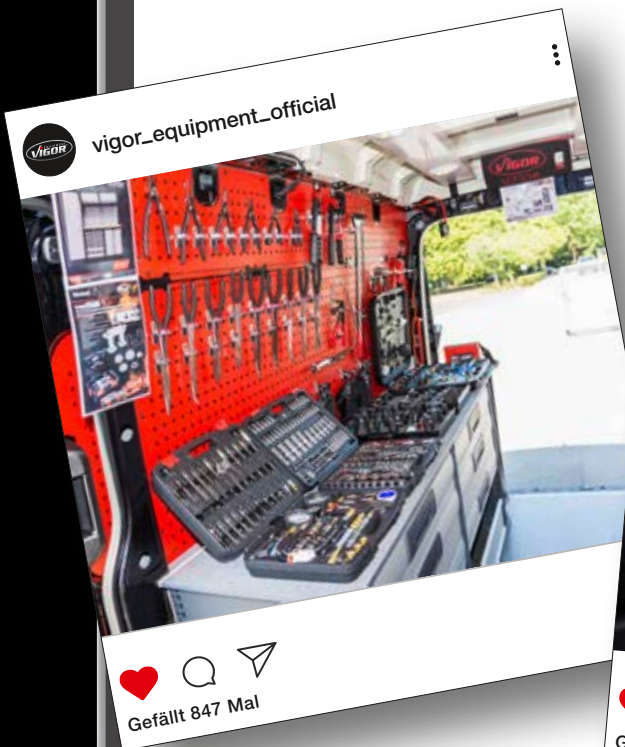

vigor_equipment_official



Oil service

Oil dipsticks	279
Oil filter tensioner adjusters	280–281
Oil pumps and filling devices	282–285

Oil dipsticks



V5048, EAN 4047728050487

Tank sensor key · universal

- Operation of locking on tank sensor
- For areas with restricted access

Proper and time-saving working without damaging the lock ring

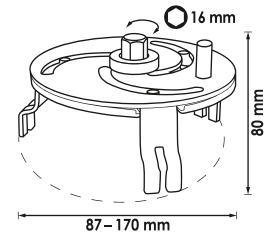

88.72 €
excl. VAT

V2112, EAN 4047728021128

Oil dipstick set MERCEDES-BENZ

- Measuring the level of engine and automatic gearbox oil
- Essential after each oil change (vehicle provided by the manufacturer without dipstick, only with sealing plug)



Manual

Automatic

143.50 €
excl. VAT

V2645, EAN 4047728026451

Oil dipstick AUDI

- Check the level after oil change and subsequent comparison with the display
- For models with oil level indicator on the display (no dipstick in the engine)
- Helpful after replacing the oil sensor or calibrating the indicator in the driver's display (comparable to T40178)
- Application: for AUDI A4 / A5 / A6 with engines 1.8 · 2.0 TFSI / 3.0 · 3.2 FSI / 2.0 · 2.7 · 3.0 TDI, among others

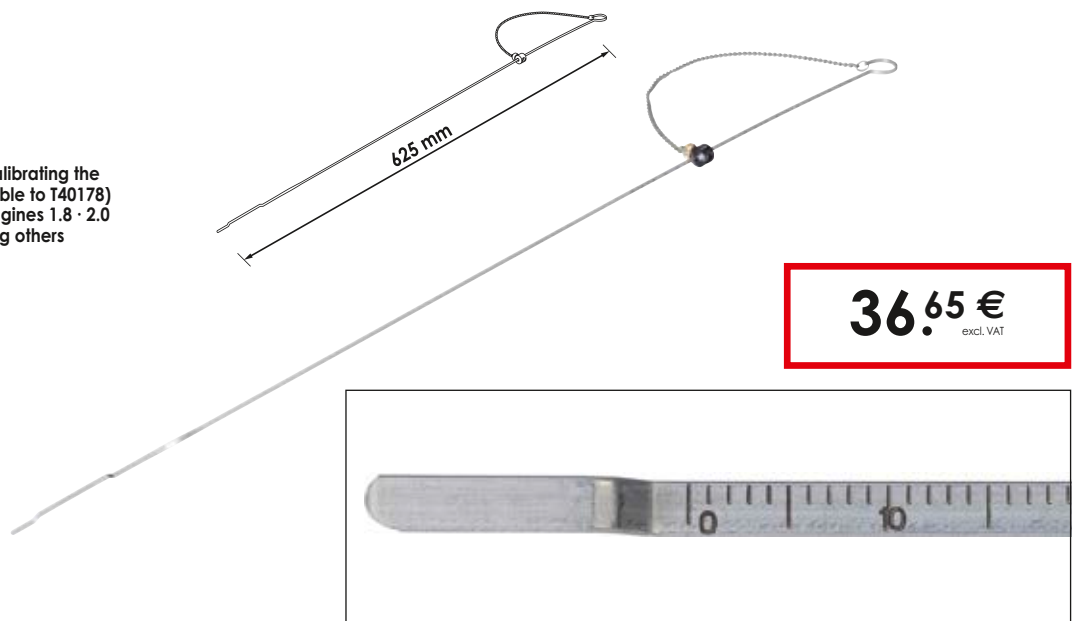

36.65 €
excl. VAT



V6027, EAN 4047728060271

Oil filling adapter set

- Uncomplicated filling of engine oil into the engine filler neck
- Adapter set made of durable aluminium
- Five different adapters for almost every vehicle
- No overflowing
- Plastic funnel with 1 l capacity
- Angle extension enables simple filling of narrow areas



With B2 adapter for VW Golf 7 · SEAT León (5F) · ŠKODA Octavia 3 etc.



227.50 €
excl. VAT

V2511N, EAN 4047728068239

Oil filter strap wrench

- Installation and removal of oil filters
- Infinitely adjustable
- Setting to filter Ø by turning on the end of the handle
- Ergonomic handle



21.45 €
excl. VAT

V2521, EAN 4047728025218

Spare strap



7.55 €
excl. VAT

V1281, EAN 4047728012812

Oil Filter Claw Wrench

- Optional drive: inside square or size 21 mm outside hexagon
- Surface: galvanised



125 1/2

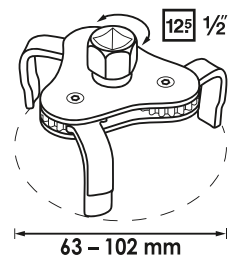

29.- €
excl. VAT

Oil filter tensioner adjusters



Oil filter tensioner adjuster · universal

- Mechanical locking of the oil filter wrench simplifies subsequent attachment of the reversible ratchet to the oil filter wrench
- The oil filter tensioner adjuster always remains under tension when the reversible ratchet is moved backwards
- Infinitely adjustable
- Use with wrench size 21 mm or $\frac{1}{2}$ reversible ratchet
- Optimal hold when loosening the oil filter thanks to left-toothed jaws
- For oil filters in areas with restricted access
- Clockwise/anti-clockwise application enables operation of the screw connection

Size 21 mm



Continuous interlinking

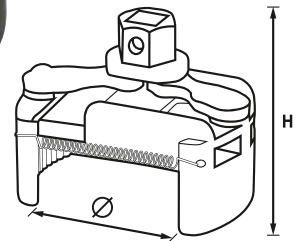

VIGOR No.	■	Height	Ø mm	EAN 4047728+	€
V4413	● 21 mm, $\frac{1}{2}$	60	60-80	044134	84.08
V4414	● 22 mm, $\frac{1}{2}$	70	80-115	044141	110.-
V4415	● 24 mm, $\frac{1}{2}$	105	115-140	062114	156.50

V4484, EAN 4047728044844

Special screwdriver bit

- Installing / removing the VAG plastic oil drain plug with special profile on oil pans
- For e.g.:
 - AUDI · SEAT · ŠKODA · VW model year 2013 → with 1.2 · 1.4 · 1.8 · 2.0 l TFSI petrol engines
 - AUDI A1 · A3 · A4 · A5 · Q5,
 - SEAT León, etc. with 1.6 und 2.0 l diesel engines
 - VW Golf 7



22.10 €
excl. VAT

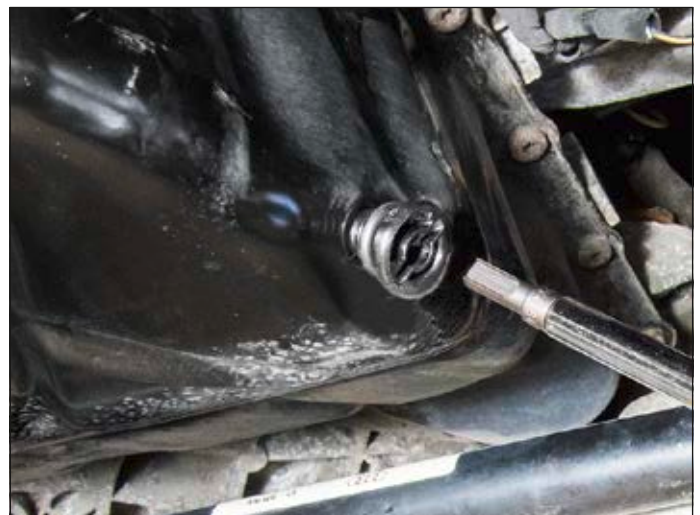

V4701, EAN 4047728073844

Mini vacuum pump

- Manual vacuum pump for extracting and filling vehicle fluids
- Fill level display is nice and clear
- Accurate dosage and easy handling thanks to ergonomic design
- Capacity: 100 ml
- Including rubber tubing with stop cap to prevent leakage
- For the following liquids:
 - Diesel
 - Petrol
 - Brake fluid
 - Antifreeze
 - Engine oil
 - Transmission oil
 - Power steering oil

NEW

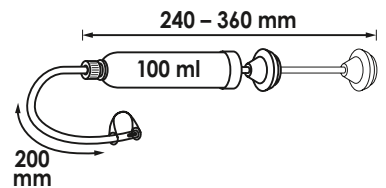

22.85 €
excl. VAT

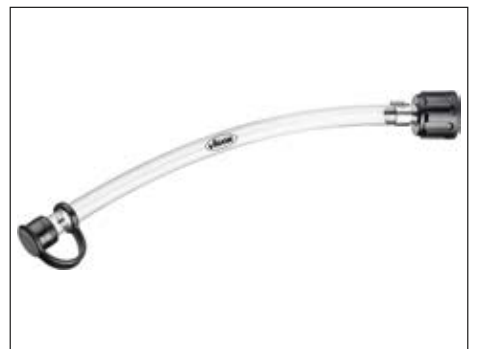

V4369, EAN 4047728043694

Vacuum pump

- Suction intake and decanting of fuels, oils and other liquids
- Capacity: 350 ml
- For the following liquids among others:
 - Diesel fuels
 - Petrol
 - Brake fluid
 - Antifreeze
 - Engine oil
 - Transmission oil
 - Power steering oil
- Contents:
 - 1 x hand pump 350 ml
 - 1 x PVC hose \varnothing 9.8 x 300 mm
 - 1 x silicone hose \varnothing 11 x 300 mm
 - 1 x drip plug
 - 1 x universal adapter



52.82 €
excl. VAT



V4201, EAN 4047728042017

Vacuum pump

- Manual vacuum pump for extracting and filling vehicle fluids
- Pre-filling the fuel filter in vehicles without a pre-filter pump, e.g. the 2.0 I TDI FORD Galaxy and Mondeo
- Capacity: 1.5 l
- For the following liquids:
 - Diesel fuels
 - Petrol
 - Brake fluid
 - Antifreeze
 - Engine oil
 - Transmission oil
 - Power steering oil

Suitable for all fuel types

5 adapters included



Scale indication



77.62 €
excl. VAT



V4201-1, EAN 4047728056588
Gasket set for V4201



29.75 €
excl. VAT



V4385N, EAN 4047728072601

Oil filling device with adapter set

- Filling gearboxes and differentials with oil
- Incl. oil pan and 16 adapters for vehicles with limited installation space

New improved set content



VIGOR No.	Designation	Design	EAN 4047728+	€
V3681	Adapter FORD · with threaded connection		036818	14.55
V3682	Adapter BMW · bent		036825	17.25
V3683	Adapter VAG · short · bent		036832	17.25
V3684	Adapter VAG · long · bent		036849	17.25
V3685	Adapter VAG · straight · with threaded connection		036856	14.55
V3686	Adapter MERCEDES-BENZ · 7-speed automatic		036863	18.33
V3687	Adapter VAG · DSG direct shift gearbox		036870	18.33
V3688	Adapter VAG CVT · continuously variable transmission		036887	18.33
V3689	Adapter Volvo · straight		036894	18.33
V3690	Adapter ŠKODA · M 18x1.5 mm		036900	18.33
V3691	Adapter VW · Passat		036917	21.02
V4113	Adapter TOYOTA · LEXUS · 18x1.5		041133	21.67
V4114	Adapter Infiniti · 7 speed M 8x1.0		041140	21.67
V4115	Multifunction adapter		041157	21.67
V4383	Adapter NISSAN · Juke M 12x1.25 mm		043830	13.58
V4384	Adapter MINI Cooper · M 14x1.5 mm		043847	17.25
V7285	Adapter NISSAN · Hybrid · M 10x1.5		072854	21.45
V7286	Adapter GM · M 12x1.75		072861	21.45
V7287	Adapter ŠKODA · M 18x1.5		072878	21.45
V7288	Adapter VAG · 7-speed dual clutch		072885	21.45

330.50 €
excl. VAT

Oil drain pan

- Collection / transfer of liquids such as oil, brake fluid or water
- The outlet opening is fitted with a web and prevents uncontrolled overflow of the liquid being refilled
- The litre scale in the pan indicates the filled quantity
- Holding device for oil filter cartridges allows for smooth emptying
- Oil drain pan with hanging hole for easy storage on perforated tool panels
- Smooth plastic surface for quick and easy cleaning

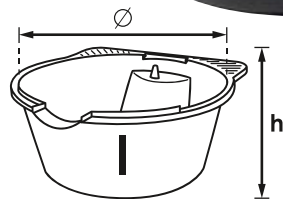

VIGOR No.	Ø mm	Filling capacity	Height	EAN 4047728+	€
V6300-5	370	5	90	068963	8.84
V6300-8	370	8	145	068970	11.-
V6300-13	420	13	175	068956	14.55



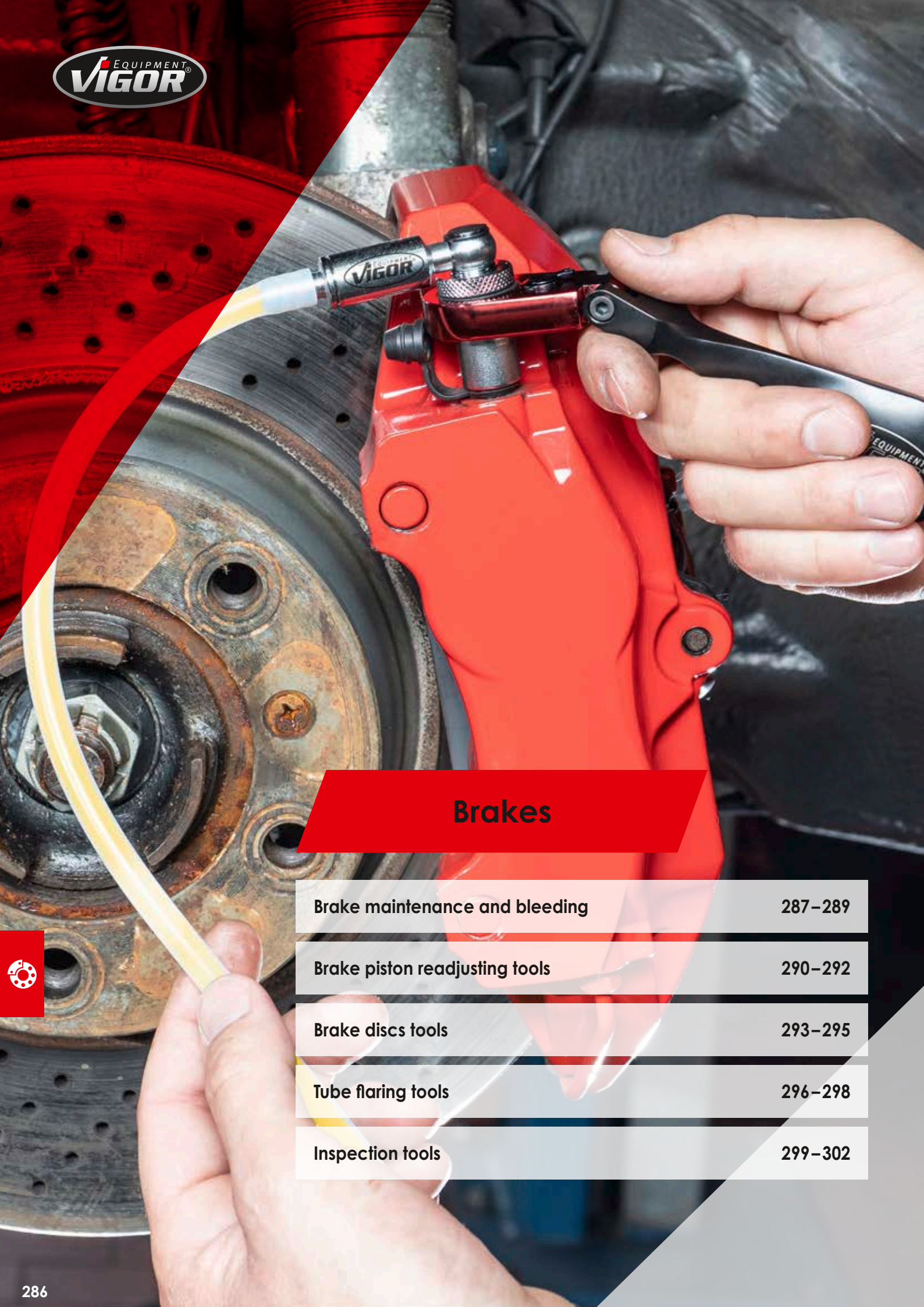

Brakes

Brake maintenance and bleeding

287–289

Brake piston readjusting tools

290–292

Brake discs tools

293–295

Tube flaring tools

296–298

Inspection tools

299–302



V4381, EAN 4047728**043816**

Adapter for brake service systems

- Together with conventional brake service devices
- Cover made from durable aluminium
- Contents:
 - Adapter E 20 W for expansion tanks with restricted access, for almost all European vehicles
 - Adapter G 75 for ISUZU · MITSUBISHI · PROTON · SUBARU · SUZUKI · Volvo · KIA
 - Adapter B 35 for CHRYSLER · FORD · NISSAN · SUBARU · HYUNDAI
 - Universal adapter with chain mounting



Bayonet fitting

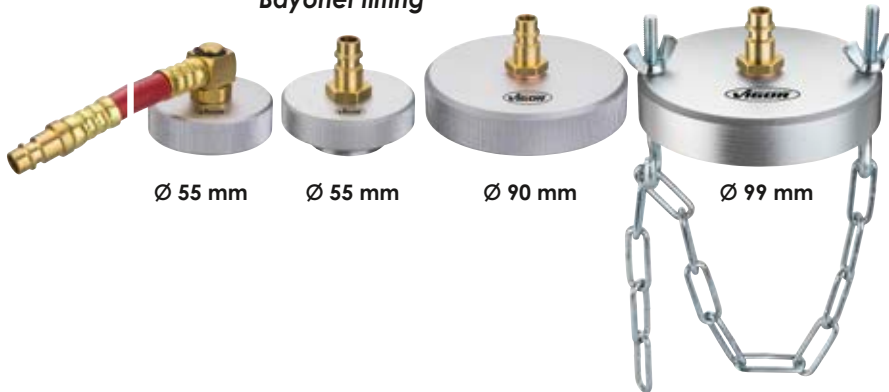

Simple and useful supplement for using service devices on almost all vehicles

214.50 €
excl. VAT

V4381-1, EAN 4047728**046930**

Adapter for brake service systems

- Adapter: 55 mm Ø
- For expansion tanks with restricted access, for almost all European vehicles
- To be used together with conventional brake service devices
- Adapter thread: M 46.5 x P 3.5



64.68 €
excl. VAT

V4381-2, EAN 4047728**046947**

Adapter for brake service systems

- Adapter: 55 mm Ø, with bayonet fitting
- For FORD · ISUZU · MITSUBISHI · PROTON · SUBARU · SUZUKI · Volvo
- To be used together with conventional brake service devices
- Lock size: Ø 33 mm



60.37 €
excl. VAT

V4381-3, EAN 4047728**046954**

Adapter for brake service systems

- Adapter: 90 mm Ø
- For CHRYSLER · FORD · NISSAN · SUBARU · HYUNDAI
- To be used together with conventional brake service devices
- Adapter thread: M 79.5 x P 30



60.37 €
excl. VAT

V4381-4, EAN 4047728**046961**

Adapter for brake service systems

- Adapter: 99 mm Ø
- To be used together with conventional brake service devices
- Lock size: Ø 78.1 mm



64.68 €
excl. VAT



V4411, EAN 4047728**044110**

Brake bleeder set 3 l · manual

- Bleeding brake and coupling systems
- Working pressure: max. 1.4 bar
- Manometer range: 0 – 2 bar
- Draining of the pressure through integrated pressure relief valve
- Contents:
 - 3 litre tank
 - E20 Euro adapter
 - Universal adapter with chain
 - Connecting hose with quick connection
 - Collection tank with connection nipple for brake systems

Especially suited for mobile use with manual pressure build-up function



Capacity: 3 litres

139.- €
excl. VAT

V4668, EAN 4047728**046688**

Brake fluid tank

- Collection tank for bleeding brake and coupling systems
- Silicone tube, length: 550 mm
- Contents of V4411

Suitable for all common bleeding valves



Capacity: 0.7 litres

27.92 €
excl. VAT

Brake maintenance and bleeding



V7471, EAN 4047728074711

Brake bleeding set

- Bleeding brake line systems, changing brake fluids without removing the wheels
Also for bleeding coupling systems
- Comfortable application thanks to ergonomic special ratchet
- Easy opening and closing of the brake nipple thanks to special hinge ratchet
- Guarantees fast access to the brake nipple even with the wheel mounted
- Good power transmission due to application-optimised handle
- Angle clutch in 90° design with back pressure valve and anti-rotation protection
- Back pressure valve protects system against ingress of air



NEW



VIGOR No.	Designation	Design	Size	EAN 4047728+	€
V7471-A	90° Universal adapter		-	074889	47.40
V7471-T	Silicon hose		-	074896	13.20
V7471-TL	Rubber hose · long		-	074865	13.20
V7471-TS	Rubber hose · short		-	074858	8.-
V7471-W	Bleeder valve ratchet		-	074872	47.40
V7471L-10	Socket · long · 10 mm		10 mm	074834	13.20
V7471L-11	Socket · long · 11 mm		11 mm	074827	13.20
V7471S-10	Socket · short · 10 mm		10 mm	074759	9.80
V7471S-11	Socket · short · 11 mm		11 mm	074766	9.80

Optional accessories (not included in delivery)

VIGOR No.	Designation	Design	Size	EAN 4047728+	€
V7471S-7	Socket · short · 7 mm		7 mm	074728	9.80
V7471S-8	Socket · short · 8 mm		8 mm	074735	9.80
V7471S-9	Socket · short · 9 mm		9 mm	074742	9.80
V7471S-12	Socket · short · 12 mm		12 mm	074773	9.80
V7471L-7	Socket · long · 7 mm		7 mm	074780	13.20
V7471L-8	Socket · long · 8 mm		8 mm	074797	13.20
V7471L-9	Socket · long · 9 mm		9 mm	074803	13.20
V7471L-12	Socket · long · 12 mm		12 mm	074841	13.20



132.- €
excl. VAT

V3760N, EAN 4047728066310

Brake piston readjusting tool set

- Clockwise and anti-clockwise brake pistons
- Including 4 special sockets
- Reset by pressing and simultaneously turning the brake piston
- Numbering of the adapter plates enables precise allocation
- Magnetic spindle sockets enable comfortable work
- Contents:
 - 2 spindles (anti-clockwise and clockwise)
 - 2 hex-head wrenches (6 and 7 mm)
 - 2 drift pins
 - 3 exchangeable reaction plates
 - 36 reaction plates and adapters
 - 4 special brake fitting sockets
 - 1 spindle grease
- Adapters enable use even on very worn brake linings and assembly of the back plate in the break calliper



242.50 €
excl. VAT

VIGOR No.	Designation	Design	■	∅ mm	Pin diameter	Pin height	Size	EAN 4047728+	€
V3760-1	Adapter plate 1		-	-	-	-	-	067164	5.07
V3760-2	Adapter plate 2		-	51	6	9	-	066853	9.92
V3760-3	Adapter plate 3		-	55	-	-	-	067201	7.76
V3760-4	Adapter plate 4		-	32	5	2.5	-	066631	7.76
V3760-5	Adapter plate 5		-	36	6	4	-	066648	9.92
V3760-6	Adapter plate 6		-	42	6	4	-	066655	7.76
V3760-7	Adapter plate 7		-	42	6	2	-	066662	7.76
V3760-11	Adapter plate 11		-	-	-	-	-	066679	5.50
V3760-12	Adapter plate 12		-	-	-	-	-	066686	5.50
V3760-A	Adapter plate A		-	41	6	4	-	066693	9.49
V3760-B	Adapter plate B		-	38	10	3	-	066709	9.49
V3760-C	Adapter plate C		-	38	4	3	-	066716	9.92
V3760-D	Adapter plate D		-	51	6	3	-	066723	10.56
V3760-E	Adapter plate E		-	42	5	3	-	066730	8.84
V3760-F	Adapter plate F		-	36	6	4	-	066747	10.56
V3760-G	Adapter plate G		-	32	4	3	-	066754	7.76
V3760-J	Adapter plate J		-	44	6	3	-	066761	10.56

Brake piston readjusting tools



VIGOR No.	Designation	Design	■	∅ mm	Pin diameter	Pin height	Size	EAN 4047728+	€
V3760-K1	Adapter plate K1		-	54	10	7	-	066778	11.-
V3760-K2	Adapter plate K2		-	45	6	4	-	066785	9.92
V3760-M	Adapter plate M		-	32	6	3	-	066792	7.76
V3760-P	Adapter plate P		-	38	4	4.5	-	066808	7.76
V3760-Q	Adapter plate Q		-	32	5.5	3	-	066815	9.49
V3760-R	Adapter plate R		-	36	6	4	-	066822	9.92
V3760-S	Adapter plate S		-	38	4	3	-	066839	9.92
V3760-T	Adapter plate T		-	28	5	4	-	066952	9.92
V3760-V	Adapter plate V		-	40	4	2.5	-	066969	9.49
V3760-X	Adapter plate X		-	-	-	-	-	066976	9.49
V3760-Z	Adapter plate Z		-	30	4	4.5	-	066983	9.49
V3760-8	Adapter plate 8		-	48	5.5	3	-	066990	9.92
V3760-9	Adapter plate 9		-	54	5.5	3	-	067003	11.-
V3760-0	Adapter plate 0		-	63.5	5.5	3	-	067010	11.-
V3760-0-DISC	Adapter plate 0-DISC		-	59	-	-	-	067027	6.58
V3760-K	Adapter plate K		-	54	8	4	-	067034	9.92
V3760-N	Adapter plate N		-	32	12	5	-	067041	9.49
V3760-IV	Adapter plate IV		-	42	6	9	-	067058	9.49
V3760-H6	Adapter plate H6		-	-	-	-	-	067065	9.49
V3760-H7	Adapter plate H7		-	-	-	-	-	067072	9.49
V3760-A1	Adapter plate A1		-	40	5.5	4	-	067089	9.92
V3760-B1	Adapter plate B1		-	45	6	5	-	067096	9.92
V3760-F1	Adapter plate F1		-	44	4	3.5	-	067102	9.92
V3760-P1	Adapter plate P1		-	37	6	3.5	-	067119	9.92
V3760-G1	Pressure plate G1		-	42	5	5	-	067133	9.92
V6632	Socket		10 3/8	-	-	-	9 mm	066327	16.60
V6633	Socket		12 1/2	-	-	-	22 mm	066334	16.60
V6634	Socket		12 1/2	-	-	-	20 mm	066341	16.60
V6635	Socket		12 1/2	-	-	-	11.5 mm	066358	16.60

V3760-VW, EAN 4047728071666

Adapter VW

• Adapter VW



(not included)

10.67 €
excl. VAT

V1711N, EAN 4047728060738

Brake piston readjusting tool set · pneumatic

- Pushing and turning of brake pistons on nearly all passenger cars
- Efficient, damage-free working on brake systems
- For clockwise and anti-clockwise brake pistons
- Makes controlled rewinding by hand possible, in addition to pneumatic support
- Quick-connectors allow adapters to be mounted easily
- Automatic balancing of different thread pitches
- Set with 23 pieces: 1 pneumatic spindle · 22 adapter plates



Now even greater
market coverage



183.50 €
excl. VAT

V1711-1, EAN 4047728067331

Brake piston readjusting tool · pneumatic

- For right- and left-hand threads
- Protects against damage to sleeve gaskets
- Makes simultaneous operation and turning possible
- Magnet on the socket ensures the adapter is secure

92.- €
excl. VAT



Brake discs tools



V7158, EAN 4047728071581

Brake calliper screw connection set

- Brake calliper screw connections on, for example, VW · AUDI · PORSCHE · MERCEDES-BENZ · BMW · FORD · MAZDA and Volvo
- Including all common profile sizes for removal / installation of the brake calliper
- Special profiles for loosening the screw connections of separated brake callipers
- Ideal for floating and fixed brake callipers



70.07 €
excl. VAT

VIGOR No.	Designation	Design	■		Size	mm	EAN 4047728+	€	
V6633	Socket		12 ²⁹	1/2	-	22 mm	066334	16.60	
V6634	Socket		12 ²⁹	1/2	-	20 mm	066341	16.60	
V6635	Socket		12 ²⁹	1/2	-	11.5 mm	066358	16.60	
V6636	Socket		12 ²⁹	1/2	-	14 mm	071406	21.45	
V7158-1	Socket		10	3/6	●	7 mm	24	071598	10.67
V7158-2	Socket		10	3/6	●	8 mm	24	071604	10.67
V7158-3	Socket		6.3	1/4	●	9 mm	20	071611	10.67
V7158-4	Socket		10	3/6	○	9 mm	50	071628	10.67
V7158-5	Socket		10	3/6	○	7 mm	65	071635	10.67
V7158-6	Socket		10	3/6	○	7 mm	92	071642	10.67
V7158-7	Socket		10	3/6	○	11 mm	100	071659	10.67
V7158-8	Socket		10	3/6	○	8 mm	-	071888	16.06

V6632, EAN 4047728066327

Socket

- Brake calliper screw connections on, for example, VW · AUDI · PORSCHE · MERCEDES-BENZ · BMW · FORD · MAZDA and Volvo



16.60 €
excl. VAT

V4930, EAN 4047728**049306**

Calliper gauge for brake discs

- Fast, effective determination of the brake disc diameter without removing the wheel first
- Time saving through clear identification of the installed brake system (advantage: fewer incorrect orders)
- Universal clamping range: 200–400 mm

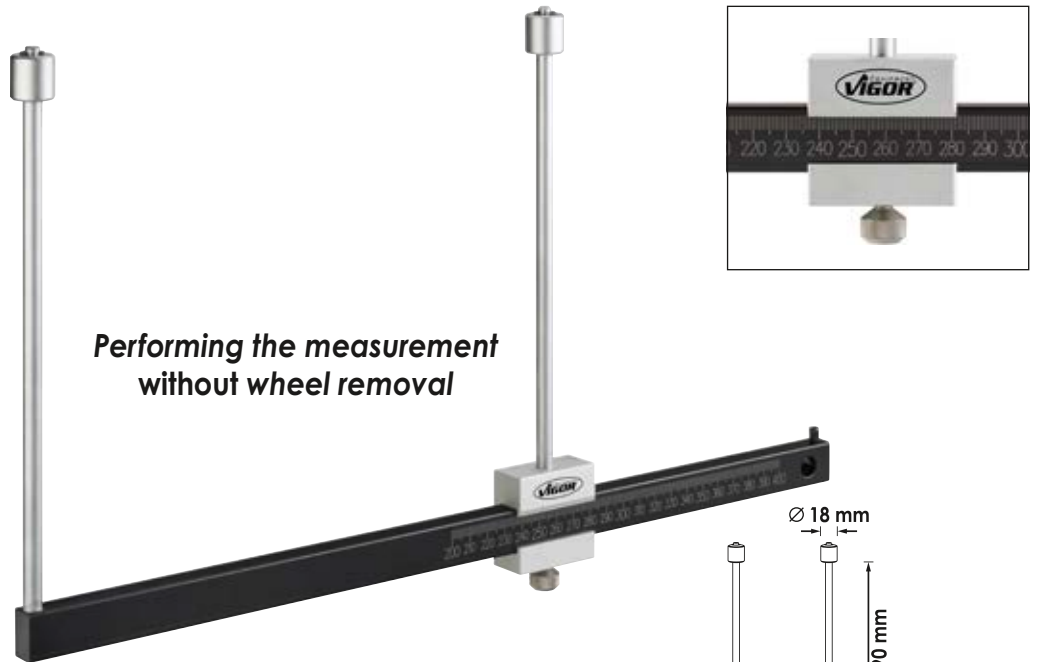

Performing the measurement without wheel removal

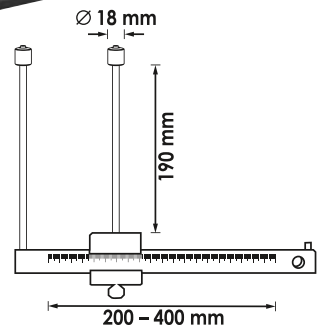

113.-€
excl. VAT

V4399, EAN 4047728**043991**

Brake disc thickness gauge

- Fast, efficient test for determining the current brake disc thickness
- Note: see the manual of the vehicle manufacturer for the minimum wear limits of the brake discs

Performing the measurement without wheel removal



Display range 0 – 45 mm

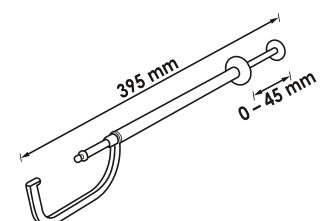

52.82 €
excl. VAT

V7401, EAN 4047728074018

Brake disc thickness gauge · digital

- Measuring minimum thickness of brake discs
- Performing the measurement without wheel removal
- Digital LCD display
- Stainless steel design
- Note: note the minimum wear limits of the brake discs from the vehicle manufacturer manual
- Including 3 volt battery CR2032
- Measuring range of 0 – 80 mm



106.50 €
excl. VAT



V4416, EAN 4047728**044165**
Tube flaring tool for Ø 4.75 mm

- Exclusively for DIN flaring
- Lightweight and easy to handle
- Exact positioning of the brake line in the device using a spacing adapter
- Application on brake and hydraulic lines directly on the vehicle
- For thin-walled pipes made of steel, aluminium and copper (metric / inch)
- No damage to coated lines
- For DIN „F“ flares 180°



For DIN
 „F“ flares



Particularly suited for direct use on the vehicle

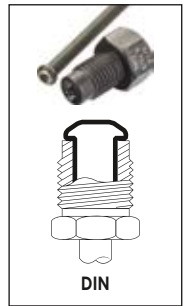

VIGOR No.	Designation	Design	EAN 4047728+	€
V4416-1	DIN flaring screw 4.75 mm		049313	18.76
V4416-2	Screw sleeve		049337	18.76
V4416-3	Spacing screw		049344	9.06
V4416-4	Bolt		049351	2.26
V4416-5	Handle		049375	9.06

80.85 €
 excl. VAT

V4697, EAN 4047728**046978**
Tube flaring tool for Ø 4.75 mm

- Flared tube ends of Ø 4.75 mm lines according to DIN and SAE standards
- Extremely small construction ensures that it is possible to work in confined spaces
- No damage to coated lines
- Distance adapter prevents incorrect positioning of the brake line
- For steel, aluminium and copper lines
- For 180° DIN „F“ flares, as well as SAE „F“ double flares
- Contents:
 - 1 basic unit
 - 1 DIN flare adapter
 - 1 SAE flare adapter
 - 1 distance adapter
 - 1 special grease



For DIN · SAE
 and F flares



Particularly suited for direct application on the vehicle due to easy handling

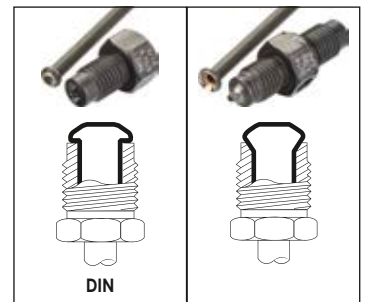

VIGOR No.	Designation	Design	EAN 4047728+	€
V4416-1	DIN flaring screw 4.75 mm		049313	18.76
V4416-2	Screw sleeve		049337	18.76
V4416-3	Spacing screw		049344	9.06
V4416-4	Bolt		049351	2.26
V4697-1	Flaring screw (SAE) · 4.75 mm		049320	24.69
V4697-2	Handle		049368	11.75

147.- €
 excl. VAT

Tube flaring tools



V1728, EAN 4047728017282

Tube flaring tool set

- Direct application on brake and hydraulic lines on vehicles
- For thin-walled pipes made of steel, aluminium and copper (metric / inch)
- Producing convex and double flares (DIN/SAE standards)
- No damage to coated lines
- For 180° DIN "F" flares and SAE "F" double flares, as well as simple "D" flares



For DIN ·
SAE flares

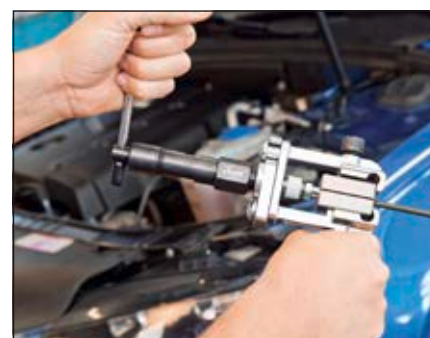

VIGOR No.	Designation	Design	EAN 4047728+	€
V2466	Quick-change holder		024662	60.04
V2559	Basic unit		025591	146.50
V2467	Hydraulic spindle		024679	117.50
V2558	Thrust block 90° DIN / SAE		025584	21.67
V2553	Thrust block DIN/SAE		025539	21.67
V2554	Thrust block DIN/SAE		025546	21.67
V2556	Thrust block DIN/SAE		025560	21.67
V2555	Thrust block DIN/SAE		025553	21.67
V2626	Tube cutter		026260	14.34
V2551	Pair of gripping jaws		025515	34.39
V2552	Pair of gripping jaws		025522	34.39
V2540	Pair of gripping jaws		025409	34.39
V1782	Tube bending tool		017824	26.52

322.50 €
excl. VAT



V5513, EAN 4047728055130

Tube flaring tool set

- Flaring steel, aluminium or copper brake lines with \varnothing 4.75 · 5 · 5.15 · 5.25 · 6 mm
- Modern BMW and VAG brake lines are covered with an additional plastic layer (\varnothing 5.15 / 5.25 mm)
- Flaring is not possible with standard tube flaring tools
- Exclusively for DIN flaring
- Direct application on brake and hydraulic lines on vehicles

For new VAG and BMW brake lines with additional covering

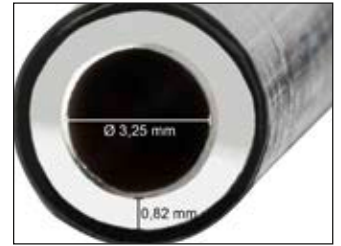

New brake line



Positioning of line to scrape the covering



Mounting the union nut



Positioning the line



DIN flaring process



VIGOR No.	Designation	Design	EAN 4047728+	€
V5513-1	DIN flaring screw 6 mm		055147	21.13
V5513-2	Line cutter 3 - 16 mm		055154	24.58
V5513-3	Line scraper 3 - 16 mm		055161	35.14
V4416-1	DIN flaring screw 4.75 mm		049313	18.76
V4416-2	Screw sleeve		049337	18.76
V4416-3	Spacing screw		049344	9.06
V4416-4	Bolt		049351	2.26
V4697-2	Handle		049368	11.75
V1782	Tube bending tool		017824	26.52

334.- €
excl. VAT

V5649, EAN 4047728056496

Deburrer for brake lines · inside / outside

- For deburring of brake lines
- For inside pipe \varnothing 3 – 12 mm
- For outside pipe \varnothing 4 – 14 mm
- For deburring of brake lines
- For steel, copper, stainless steel, aluminium lines

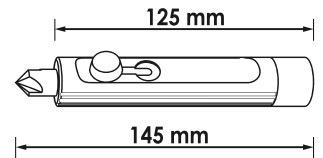

37.19 €
excl. VAT

V2789N, EAN 4047728062824

Brake and fuel line inspection tool

- Detection of hidden corrosion during general inspection
- 12 cleaning edges for removal of dirt and rust from various lines
- \varnothing 3.5 mm · 4.0 mm · 4.75 mm

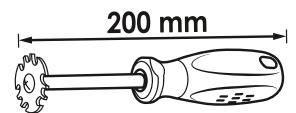

14.34 €
excl. VAT

V5691, EAN 4047728056915

Brake calliper file

- For removing brake dust, rust and dirt from the brake calliper without damaging the brake sleeves
- Extremely narrow design allows high flexibility
- All four sides of the square are toothed with 2 different thicknesses (cut)
- Width square: 9 mm

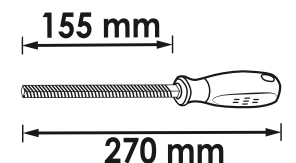

36.11 €
excl. VAT



V5909, EAN 4047728059091

Brake hook

- For hanging up the brake calliper during work on brakes (damage to the brake hose prevented)
- Also for hanging up hoses or cables
- Surface: dip-insulated



14.98 €
excl. VAT

V2249, EAN 4047728022491

Brake calliper brush · brass

- Cleaning aluminium brake callipers
- Removal of stubborn brake dust
- Allows access into small brake callipers

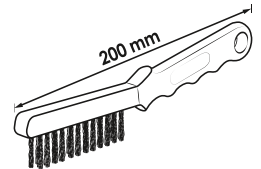

14.34 €
excl. VAT

V2250, EAN 4047728022507

Brake calliper brush · steel

- Removal of stubborn brake dust
- Very slim design

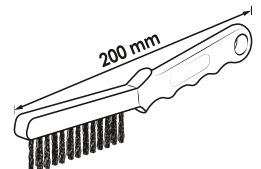

11.- €
excl. VAT

V6917, EAN 4047728069175

Brake line ratcheting tube cutter

- Space saving, with ratchet mechanism. For 4.75 mm brake lines
- Ratcheting mechanism in the head of the tool minimises space required – can be used directly on the vehicle
- No readjustment of the cutting wheel due to self-adjustment
- Faster cutting result than conventional line cutters
- Adjustment of the self-adjusting cutting force possible
- Spare blades V6917-REP

Self-adjusting



42.04 €
excl. VAT

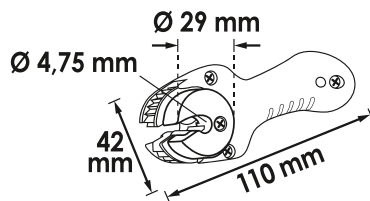

V6917-REP, EAN 4047728069199

Spare cutter wheel for brake line ratcheting tube cutter V6917



5.50 €
excl. VAT

V1782, EAN 4047728017824

Tube bending tool

- For tubes made of copper, brass, aluminium and soft steel
- Can be bent up to 90°
- Bending pipes measuring 3 mm, 4.75 mm and 6 mm Ø



26.52 €
excl. VAT



V7244, EAN 4047728072441

Brake line straightening tool Ø 4.75 mm

- Easy straightening of 4.75 mm lines
- Especially for brake lines made of steel or copper-nickel
- Effective method for straightening misshapen lines, especially for reels
- Simply sliding back and forth is sufficient as an application impulse
- Targeted straightening reduces the material costs
- Replaces conventional, imprecise shaping of wires



106.50 €
excl. VAT

V7259, EAN 4047728072595

Brake line bending tool Ø 4.75 mm

- Bending device for easy duplication of brake pipes that keep their shape



32.23 €
excl. VAT

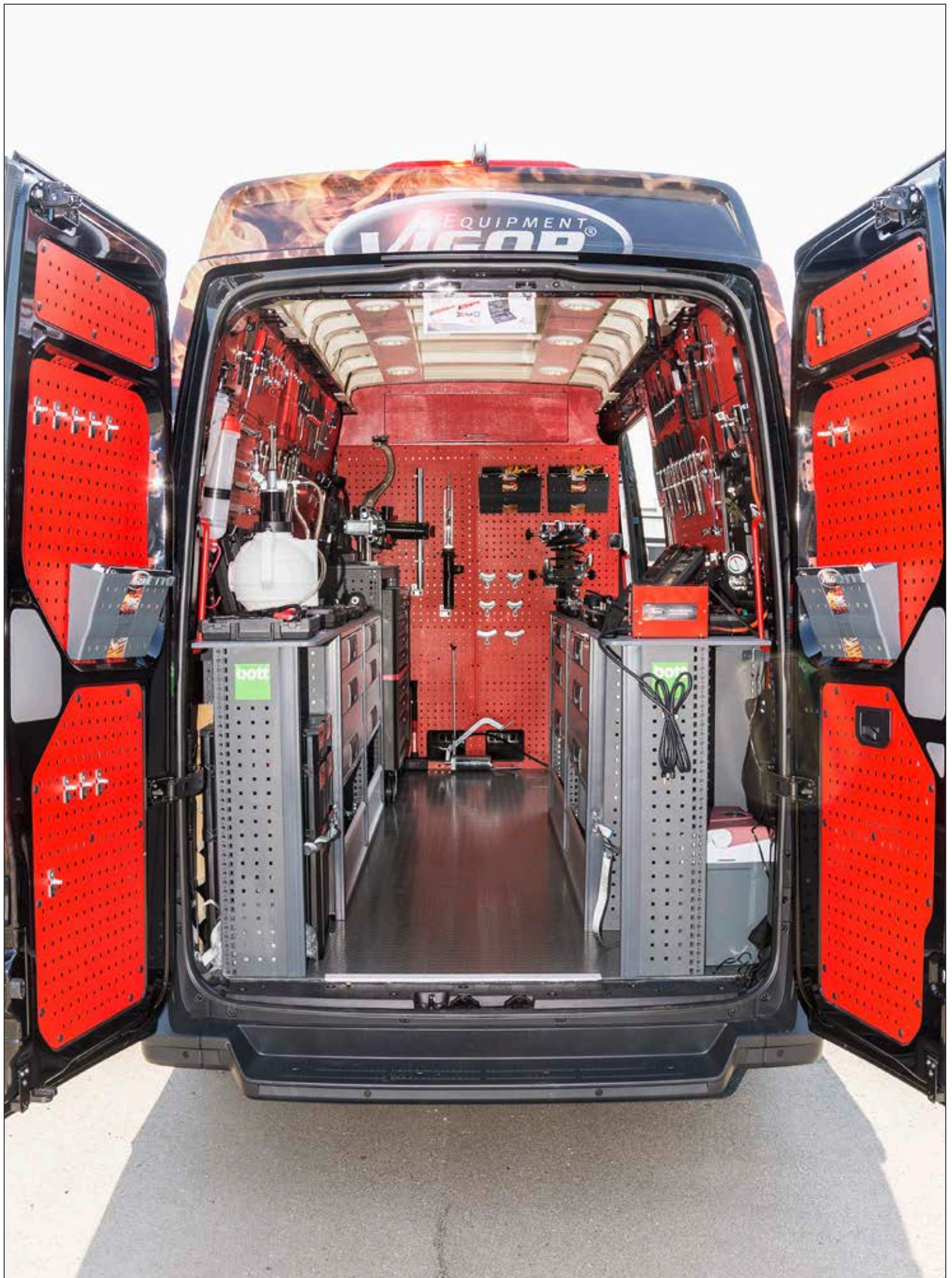

-
-
-
-
-
-
-
-
-
-
-
-
-



Wheels / tyres

Impact sockets

305-307

Service jacks and jack stands

308-311

Wheel/tyre tools

311-315

Impact sockets



V6309, EAN 4047728075534

Impact socket set

- Operation of damaged 19 mm FORD wheel nuts
- For e.g.: FORD B-Max · C-Max · Fiesta · Focus · Mondeo · Transit
- Contents:
 - 18.5 mm impact socket for wheel nuts with missing chrome cap
 - 19.5 mm impact socket for wheel nuts with deformed chrome cap

Size 18,5 mm

Size 19,5 mm

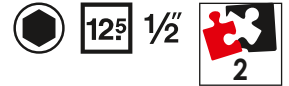

NEW

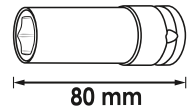

24.- €
excl. VAT

The 19 mm FORD wheel nuts can deform and expand due to weather conditions. It is therefore no longer possible to use a conventional 19 mm socket. Likewise, the chrome-plated protection cap of these wheel nuts often goes missing or is damaged. Our solution: intermediate sizes with 18.5 mm and 19.5 mm inside hexagon profiles.



V5930, EAN 4047728059305

Impact wrench socket · long

- Damage-free operation of wheel bolts by rotating plastic sleeve
- For impact operation

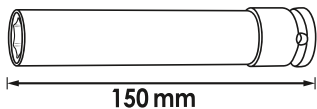

Size 17 mm



29.11 €
excl. VAT

Comparison of standard nut-driver with extra long socket wrench



V5931, EAN 4047728060318

Impact wrench socket · long

- Damage-free operation of wheel bolts by rotating plastic sleeve
- For impact operation

Size 19 mm

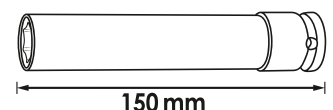

29.11 €
excl. VAT

V4309, EAN 4047728**043090**

Impact wrench socket · MERCEDES BENZ

- Operating wheel bolts with a MERCEDES-BENZ special profile
- For MERCEDES-BENZ · e.g.:
 - C-Class · GLK (W204),
 - E-Class (W211 · W212 · W207),
 - SLK (W172),
 - M-Class (W164 · W166),
 - CL-Class (W216),
 - S-Class (W221, W222)
 - MAYBACH
- For impact operation



17.14 €
excl. VAT

V2522, EAN 4047728**025225**

Impact socket set

- For impact operation

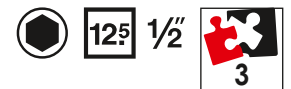

34.50 €
excl. VAT

VIGOR No.	mm	Size	EAN 4047728+	€
V2472	85	17 mm	024723	11.43
V2473	85	19 mm	024730	12.50
V2474	85	21 mm	024747	13.69

V2257, EAN 4047728**022576**

Impact socket set

- For impact operation

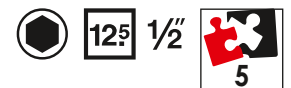

54.44 €
excl. VAT

VIGOR No.	mm	Size	EAN 4047728+	€
V2471	85	15 mm	024716	11.43
V2472	85	17 mm	024723	11.43
V2473	85	19 mm	024730	12.50
V2474	85	21 mm	024747	13.69
V2475	85	22 mm	024754	14.77

Impact sockets



V4431, EAN 4047728**044318**

Tyre pressure control system (TPMS) tool set

- Easy, professional installation of TPMS sensor and valve on every rim
- Including 2 torque screwdrivers for precise tightening torques of 0.2 – 2 Nm and 2 – 10 Nm
- Installing and removing tyre valve cores

6.3 1/4 6.3 1/4



182.- €
excl. VAT



V2481, EAN 4047728024815

Hydraulic aluminium service jack 1.35 tonnes

- Wheel change on the vehicle or repairs under the vehicle, for which a lifting platform is not necessary
- \approx 10 kg

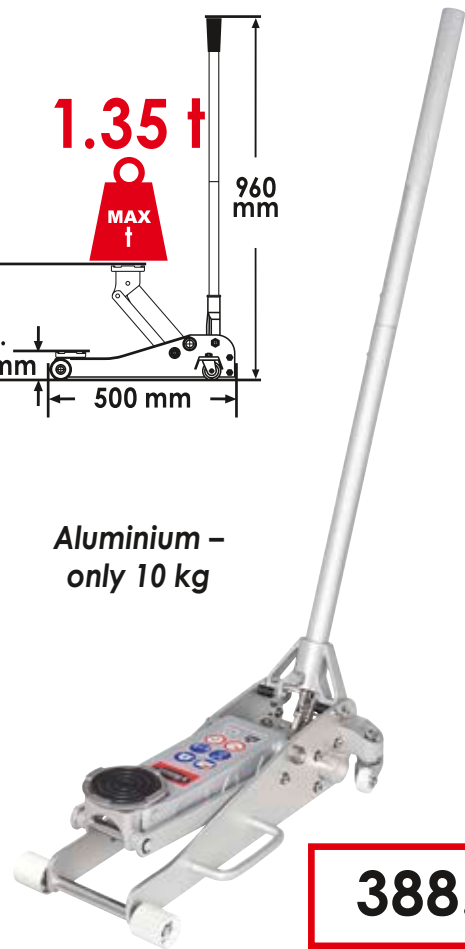
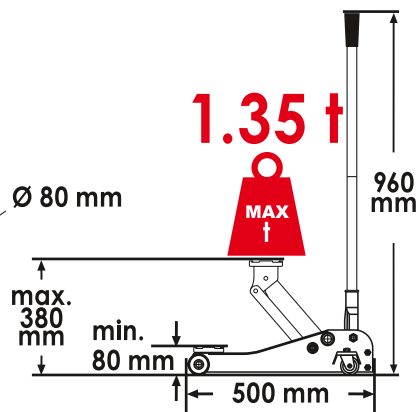
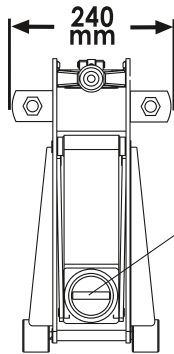

Aluminium –
only 10 kg

388.- €
excl. VAT

VIGOR No.	Designation	EAN 4047728+	€
V2631	Fixed castor (pair)	026314	23.50
V2632	Swivel castor (pair)	026321	23.50
V2639	Hydraulic unit	026390	221.-
V2640	Rubber pad	026406	11.10

V6028, EAN 4047728060288

Hydraulic service jack 2 tonnes · ultra-flat

- Wheel change on the vehicle or repairs under the vehicle, for which a lifting platform is not necessary
- Solid rubber pad for firm hold
- Fast lift thanks to turbo-lift function
- Robust steel body - guarantees high quality
- Quiet castors made from Polyurethane
- \approx 32 kg

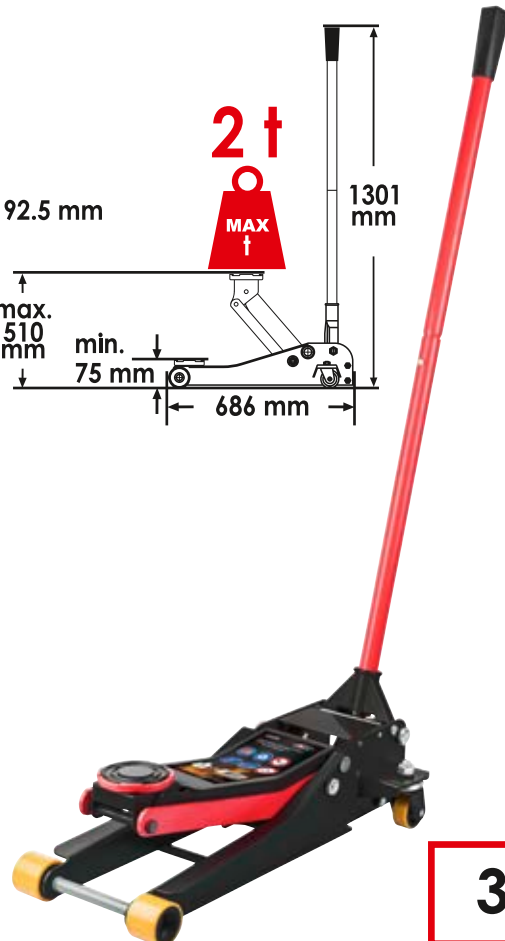
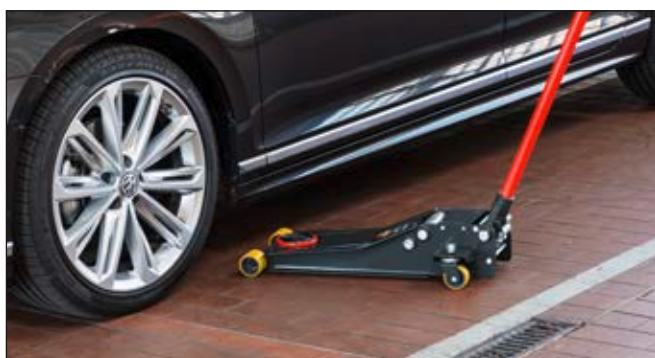
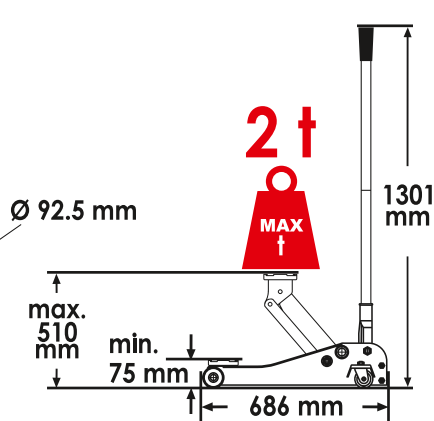
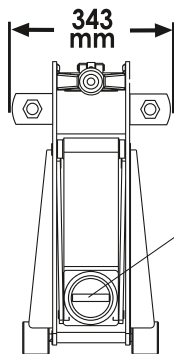

388.- €
excl. VAT

VIGOR No.	Designation	EAN 4047728+	€
V6028-1	Fixed castor (pair)	062503	23.50
V6028-2	Swivel castor (pair)	062497	23.50
V6028-3	Rubber pad	062480	11.10

Service jacks and jack stands



V6031, EAN 4047728071109

Hydraulic service jack 2 tonnes · extra long

- Wheel change on the vehicle or repairs under the vehicle, for which a lifting platform is not necessary
- ⚖ 42 kg

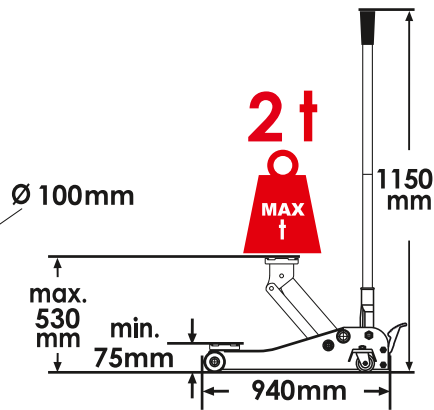
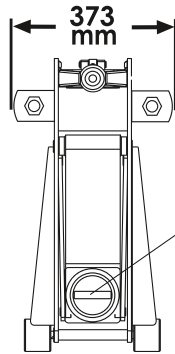

430.- €
excl. VAT

VIGOR No.	Designation	EAN 4047728+	€
V6031-1	Fixed castor (pair)	075879	34.90
V6031-2	Swivel castor (pair)	075886	29.90
V6031-3	Rubber pad	075893	11.10

V6029, EAN 4047728069786

Hydraulic service jack 3 tonnes

- Wheel change on the vehicle or repairs under the vehicle, for which a lifting platform is not necessary
- ⚖ 31 kg
- Compact design
- Quiet castors made from Polyurethane

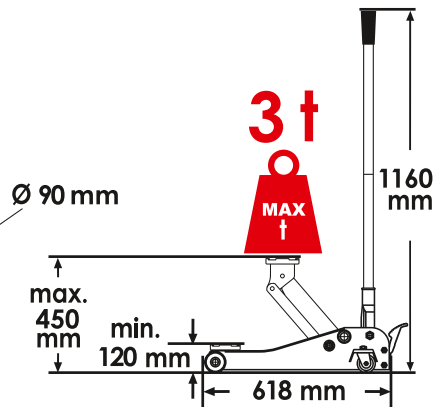
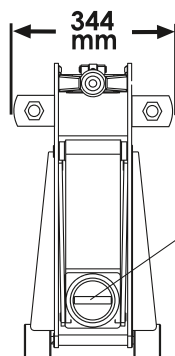

Foot pedal enables quick attachment to the service jack point



420.50 €
excl. VAT

VIGOR No.	Designation	EAN 4047728+	€
V6029-1	Fixed castor (pair)	075855	34.90
V6029-2	Swivel castor (pair)	075848	29.90
V6029-3	Rubber pad	075862	11.10



V2478, EAN 4047728024785

Hydraulic bottle jack 6 tonnes

- Vertical and horizontal applications
- ⚖️ 4.4 kg



V2477, EAN 4047728024778

Jack stand set 3 tonnes

- ⚖️ 5.2 kg per pair
- Loading capacity: 3 tonnes
- Height 315 - 460 mm
- Depth: 230 mm

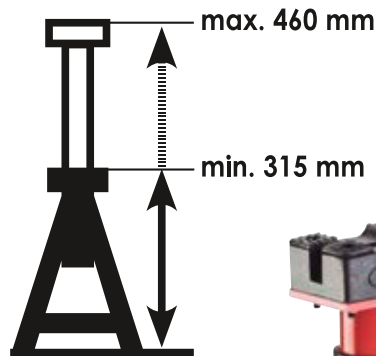

Price per pair

102.50 € excl. VAT

VIGOR No.	Designation	EAN	€
V2762	Rubber pad	4047728+027625	11.-

Service jacks and jack stands

Wheel/tyre tools



V2648, EAN 4047728026482

Jack stand set 6 tonnes

- 2 x 11 kg per pair
- Loading capacity: 6 tonnes
- Height 370 – 575 mm
- Depth: 300 mm

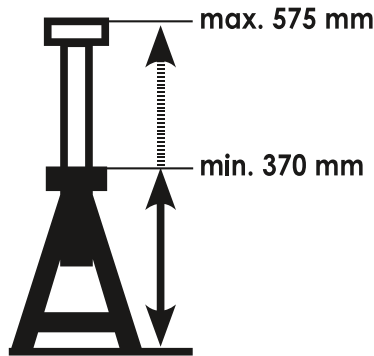

VIGOR No.	Designation	EAN 4047728+	€
V2762	Rubber pad	027625	11.-

Price per pair

199.50 €
excl. VAT

V3657, EAN 4047728074520

Balance weight pliers

- Loosening and fastening balance weights
- Jaw opening optimally adapted to the shape of the balance weights
- Cutting mode for cutting goods by the metre
- Special jaw shape enables the removal of balancing and striking weights

NEW



63.82 €
excl. VAT



V3563, EAN 4047728035637

Tyre lever with plastic coating

- Installing and removing tyres on steel and especially on aluminium rims
- Length: 500 mm



29.65 €
excl. VAT

Chrome-plated

With replaceable plastic coating fixed with screws, including screws



VIGOR No.	Designation	EAN 4047728+	€
V3615	Plastic coating with screws	036153	9.81

V2512, EAN 4047728025126

Balance weight remover set

- Removing balance weights from light-alloy rims on motorcycles and passenger cars
- Solvent resistant
- Blunt edges may be sharpened with a file
- Also suitable for removing labels and stickers
- No damage to surfaces



VIGOR No.	mm	mm	EAN 4047728+	€
V2513	19	500	025133	9.92
V2514	22	500	025140	11.-
V2515	25	500	025157	11.64
V2516	38	500	025164	12.18

32.34 €
excl. VAT

V1657, EAN 4047728016575

Balance weight pliers

- Fastening, loosening and cutting balance weights

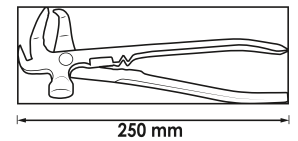

27.70 €
excl. VAT

V1584, EAN 4047728015844

Tyre tread depth gauge

- Detecting wear patterns on tyres, brake blocks and brake pads
- Zero-setting in any position
- 3 V (CR 2032) -240 mAh

Maximum
27 mm



Large LCD display
Can be switched between mm/inches

23.18 €
excl. VAT

Wheel /tyre tools



V1423, EAN 4047728014236

Tyre pressure gauge

- Quick tyre pressure check
- Small and handy
- Digital display
- Measuring ranges:
 - 0.15 – 7 bar
 - 2 – 99.5 PSI
 - 15 – 70 KPA
- 3 V (CR 2032) – 240 mAh



Automatic shut-off after 90 sec.

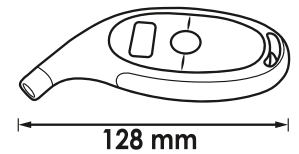

16.71 €
excl. VAT

Rubber hammer

- Loosening rusted rims during a wheel change



Non-rebound due to steel-ball filling

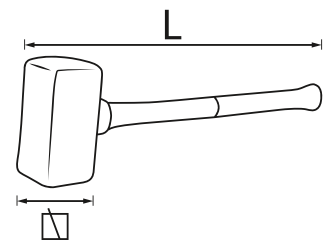

VIGOR No.	mm	kg	EAN 4047728+	€
V2235	50	2.5	022354	66.84
V2234	74	5	022347	106.50

V1571, EAN 4047728015714

Steering wheel level

- Alignment of the steering wheel during axle alignments and work around the steering column
- Quick installation
- Simple adjustment to the steering wheel
- Easy to read
- Universal use for passenger cars, vans and trucks
- Use of the steering wheel level prevents incorrect steering wheel positions
- An exact axle alignment should always be carried out using a calibrated alignment device



72.23 €
excl. VAT





V7181, EAN 4047728**071819**

Tap and die set for wheel bolts and wheel nuts

- Damaged or rusty threads can result in incorrect torque values
- Repairing and cleaning of wheel bolts and wheel nuts with inside and outside thread
- Can be used directly on the vehicle
- TIN-HSS coated surface
- In plastic case
- Suitable for the thread sizes:
 - M 12x1.25 mm
 - M 12x1.5 mm
 - M 14x1.5 mm



Damaged or rusty threads can result in incorrect torque values

Inside thread



Outside thread



VIGOR No.	Designation	Design	EAN 4047728+	€
V7181-1	Die · M 12x1.25 TIN		071840	21.45
V7181-2	Die · M 12x1.5 TIN		071833	21.45
V7181-3	Die · M 14x1.5 mm TIN		071826	21.45
V7181-4	Hand tap · M 12x1.25 TIN		071864	26.84
V7181-5	Hand tap · M 12x1.5 TIN		071857	26.84
V7181-6	Hand tap · M 14x1.5 TIN		071871	26.84

95.94 €
excl. VAT

V7001, EAN 4047728**075060**

Universal rim lock removal set

- Malleable rim key for loosening almost all rim locks
Also for rim locks with clover leaf profile, among others
- Malleable rim keys adapt to the profile by hammer strike
- Can be used on both sides
- Multiple deformation of a key side not possible
- Contents:
 - 8 rim keys
 - 2 adapters
 - Socket □ 12.5 mm (1/2") - size 24 mm
 - Impact body
 - Centring pin
 - Hand guard trim



NEW

13

266.- €
excl. VAT



V7001/4, EAN 4047728**075336**

Rim key set

- Key set with Ø 13 mm und 15 mm can be used on both sides
- For universal rim lock removal set V7001

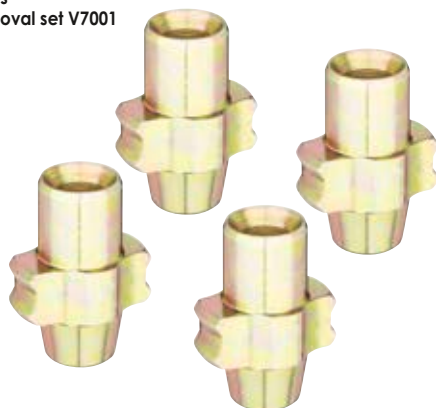

4

NEW

35.- €
excl. VAT







Body

Wiper arm puller set	318
Repair and installation sets	319
Induction heater and accessories	320–323



V2523, EAN 4047728025232

Wiper arm puller set

- Universally usable
- Allows easy removal of all common wiper arms
- Optimum usability options with rusted and stuck wiper arms
- Best possible protection for integrated wiper nozzles when used with a sliding hammer



VIGOR No.	Designation	Design	EAN 4047728+	€
V4153	Puller · universal		041539	45.49
V4154	Sliding hammer		041546	39.99
V4155	Pressure spindle		041553	14.55
V4156	Spindle extension		041560	7.22
V4157	Spindle attachment		041577	7.22
V4159	Gripper no. 1		041591	14.55
V4160	Gripper no. 2		041607	14.55
V4161	Gripper no. 3		041614	14.55
V4162	Gripper no. 4		041621	14.55
V4163	Gripper no. 5		041638	14.55
V4164	Gripper no. 6		041645	14.55
V4165	Gripper no. 7		041652	14.55
V4158	Gripper no. 8		041584	14.55

188.50 €
excl. VAT

V3551N, EAN 4047728075084

Plastic repair set

- Repair and reinforcement of plastic parts, such as cracked light bars and housing parts
- Repair and reinforcement of plastic parts
- Extensive and practical for household, workshop or handicrafts
- Plastic parts such as containers, components of any kind or cladding can be repaired immediately
- 3-in-1 function with replaceable fixtures
- Stainless steel staples
- Included in delivery:
 - 50 type W repair staples / Ø 0.6 mm
 - 50 type W repair staples / Ø 0.8 mm
 - 5 welding rods each, material PE, PS, ABS
 - 10 welding rods, material PP
 - 2 reinforced grids
- Power: 50 watts
- Maximum useful life: 35 min
- Charging time: 3.5 hours

NEW

134

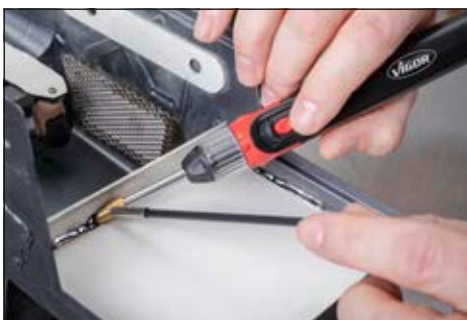
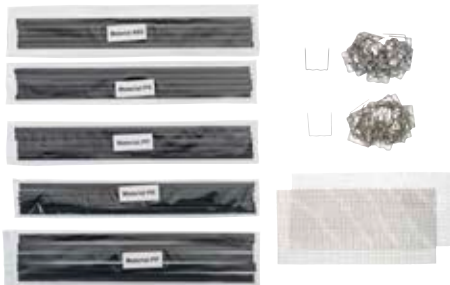

VIGOR No.	Designation	Design	EAN 4047728+	€
V3670N	Replacement staples · 0.8 mm · V-formed		075671	14.90
V3671N	Replacement staples · 0.6 mm · V-formed		075688	14.90
V3672N	Replacement staples · 0.8 mm · W-formed		075695	14.90
V3673N	Replacement staples · 0.6 mm · W-formed		075701	14.90
V3676N	Replacement staples · 0.6 mm · U-formed		075718	14.90
V3677N	Replacement staples · 0.8 mm · U-formed		075725	14.90

198.- €
excl. VAT



V4891, EAN 4047728**048910**

Induction heater

- Quick, simple removal of parts on vehicles by heating
- Extremely versatile in the car body and commercial vehicle sector due to extensive standard accessories
- Precise heating in just a few seconds with cutting-edge microprocessor technology
- Easy to transport thanks to plastic case
- Prevention of overheating with a simultaneously high degree of efficiency due to two fans
- Connecting cable: 3 m
- Reel hose length: 700 mm
- Controlled fan cooling
- Tube coils: heating pipes, bolts, profiles of various diameters
- Flexible coil: for loosening parts that are difficult to access due to the use of a special winding wire
- Flat coil for heating the car body and sheet metal, makes it easier to remove stickers, sealants etc.
- Robust IGBT transistor technology
- Short circuit and idling test
- Automatic adaptation to resonance frequency
- Frequency: 25 kHz – 60 kHz
- 1.5 kW output

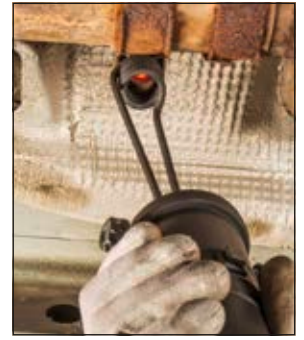

Accurately positioned heating within a few seconds due to cutting-edge microprocessor technology



Including 4 coils

1,077.- € excl. VAT

V4891-1, EAN 4047728**049573**

Tube coil

- Total length: 222 mm
- Vertical alignment
- Inside diameter 19 mm, up to maximum M 8



46.68 € excl. VAT

V4891-2, EAN 4047728**049580**

Flexible coil

- Total length: 750 mm
- Flexible use on individual motor vehicle components
- For hard-to-reach places

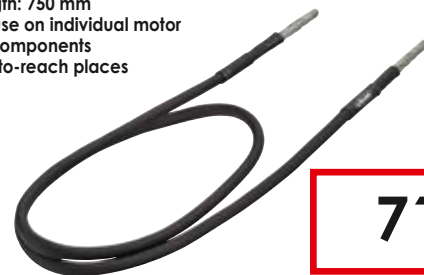

71.15 € excl. VAT

V4891-3, EAN 4047728**049597**

Tube coil

- Total length: 225 mm
- Vertical alignment
- Inside diameter 26 mm, up to maximum M 12



74.38 € excl. VAT

V4891-4, EAN 4047728**049603**

Flat coil

- Optimal for heating surfaces
- Heating of flat screws
- Total length: 227 mm
- Inside diameter: 24 mm
- Outer diameter 45 mm



52.28 € excl. VAT

V4891/6, EAN 4047728062206

Induction coil expansion set

- Set consisting of:
 - V4891-5 (Focus coil for punctual heating)
 - V4891-6 (Tube coil)
 - V4891-7 (Tube coil)
 - V4891-8 (Flexible coil, ceramic protection)
 - V4891-9 (Tube coil)
 - V4891-10 (Tube coil, lateral)



399.- €
excl. VAT

V4891-5, EAN 4047728062152

Focus coil · for punctual heating

- For heating components which can not be reached with standard coils
- Coil for heating with pinpoint accuracy, to concentrate the energy
- During heating, a distance of approx. 2 – 4 mm from the workpiece must be maintained to prevent damage to the coil
- Total length: 210 mm



87.32 €
excl. VAT

V4891-6, EAN 4047728062169

Tube coil

- Total length: 220 mm
- Vertical alignment
- Inside diameter 15 mm, up to maximum M 6



46.68 €
excl. VAT

V4891-7, EAN 4047728062176

Tube coil

- Total length: 240 mm
- Horizontal alignment
- Inside diameter 45 mm, up to maximum M 22



57.24 €
excl. VAT

V4891-8, EAN 4047728062183

Flexible coil · ceramic protection

- Total length: 800 mm
- Higher temperature resistance
- The ceramic coating extends the service life
- Self-adjusting distance for smaller components



117.50 €
excl. VAT

V4891-9, EAN 4047728062190

Tube coil

- Total length: 220 mm
- Vertical alignment
- Inside diameter 45 mm, up to maximum M 22



57.24 €
excl. VAT

V4891-10, EAN 4047728062343

Tube coil · lateral

- Total length: 230 mm
- Horizontal alignment
- Inside diameter 23 mm, up to maximum M 10



63.49 €
excl. VAT



V4891-3.5, EAN 4047728072779

Induction heater · truck 3.5 KW

- Powerful 3.5 KW variant for motor vehicles and commercial vehicle applications
- Efficient method of heating, without damaging surrounding components
- Water-cooled
- Portable, despite high performance
- Output power can be precisely adjusted for the application field
- Force can be output in increments between 10-100%
- Delivery includes cooling fluid
- Precise heating of components and elements
- Operating information via LED on the coil head
- Additional fan in the housing provides overheating protection for the hardware components
- Precise heating in just a few seconds with cutting-edge microprocessor technology



2,372.- €
excl. VAT

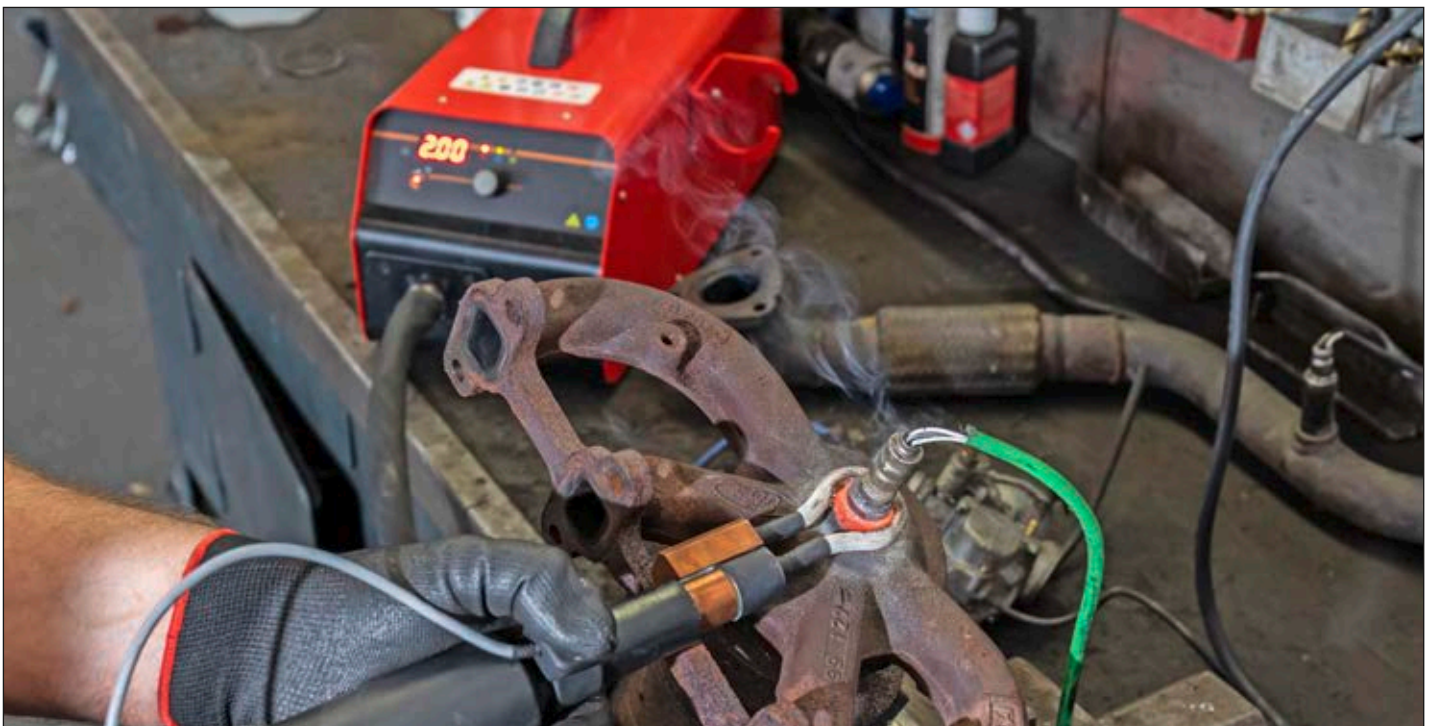

V4891-3.5-1, EAN 4047728072786

Expansion coil · Wheel bolt

• Extra slim design allows for precise heating of wheel bolts



322.50 €
excl. VAT

V4891-3.5-2, EAN 4047728072793

Standard coil · lateral



322.50 €
excl. VAT

V4891-3.5-3, EAN 4047728072809

Reducer

• Reducer for adapting plug-in coil V4891-3.5-4



160.50 €
excl. VAT

V4891-3.5-4, EAN 4047728072816

Plug-in coil · 26 mm

• Only together with V4891-3.5-3



322.50 €
excl. VAT

V4891-3.5-5, EAN 4047728072823

Cooling fluid · 3 l



43.01 €
excl. VAT

V4891-3.5-6, EAN 4047728072892

Round coil · 32 mm



322.50 €
excl. VAT



Steering tie rod joint tool

- Fast, professional replacement of axial joints on steering tie rods on passenger cars and small commercial vehicles



Roller made of metal

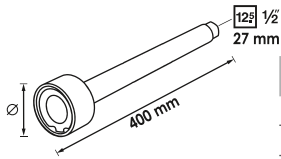

VIGOR No.	Designation	Size	L mm	EAN 4047728+	€
V2683	Steering tie rod joint tool · 35 · 45 mm	27 mm	400	026833	135.-
V2684	Steering tie rod joint tool · 28 · 35 mm	27 mm	400	026840	135.-



V3863, EAN 4047728038638

Shock absorber assembly tool set

- Installation / removal on shock absorbers with rebound spring
- Clamping pieces with V-formed plastic inserts enable fixation in final stop position without causing any damage
- For: BMW · FIAT · FORD · MERCEDES-BENZ · NISSAN · PEUGEOT · TOYOTA
- Contents:
 - Special base component
 - Sturdy threaded spindle M 12 with special receptacle
 - Universal clamping piece with V-formed plastic inserts

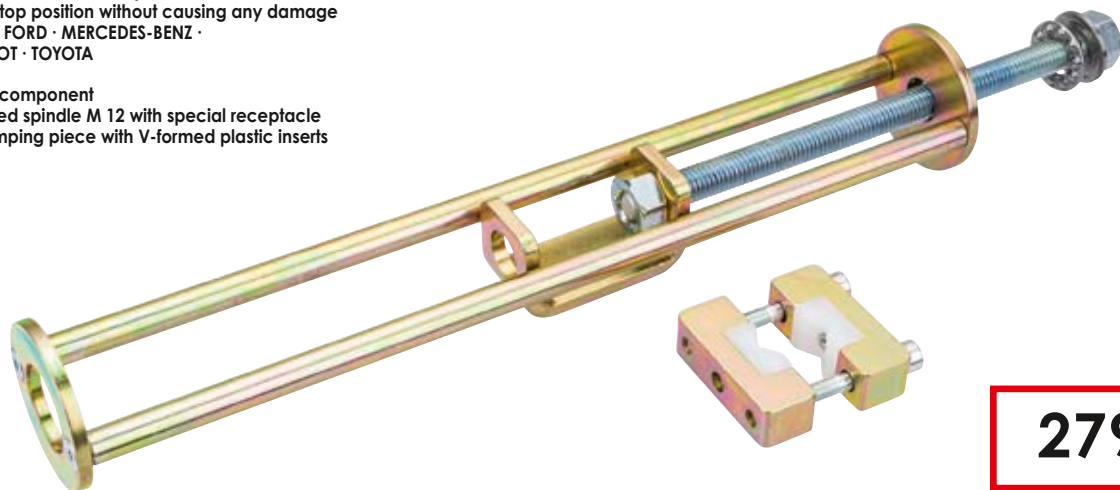

279.- €
excl. VAT



V3661, EAN 4047728036610

Clamping piece with plastic protective jaws (universal)



110.- €
excl. VAT

V4126, EAN 4047728**041263**

Clamping screw removal tool set for four-link axle VAG

- Loosening the clamping screw on the four-link axle
- For VAG vehicles, e.g. AUDI A4 · A6 etc.
- Can also be used in aluminium axle knuckles
- Contents:
 - 3 high-performance drills (HSS cobalt), size: 6 · 8.5 · 10 mm
 - 1 pressure clamp
 - 1 ejector drift



Drilling with maximum 600 rpm



V4248
6 mm



V4249
8.5 mm

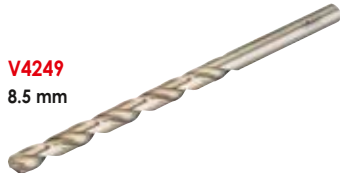

V4250
10 mm

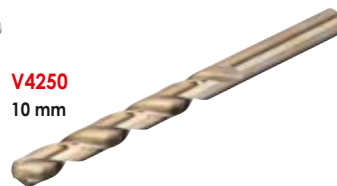

VIGOR No.	Designation	EAN 4047728+	€
V4248	HSS drill 6 mm	042482	34.60
V4249	HSS drill 8.5 mm	042499	53.36
V4250	HSS drill 10 mm	042505	34.60

470.- €
excl. VAT



V4636, EAN 4047728**046367**

Inner bearing extractor

- Universal application for all vehicle types
- For inner bearing rings in clamping range 40 – 60 mm
- Due to adapted construction style also for models with ABS housing e.g. VW Golf 4
- Conically shaped tightening screw ensures an even distribution of the clamping force
- For inner bearing rings that rest against the wheel hub

Size 22 mm

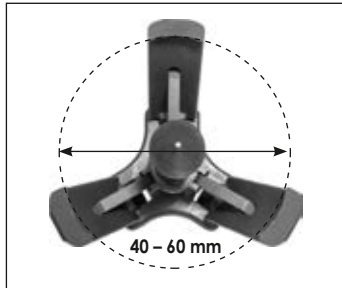

Size 36 mm



293.- €
excl. VAT

V4636-1, EAN 4047728**071680**

Replacement set · foot and 2 pins

Foot and 2 pins for V4636



43.98 €
excl. VAT

V6452, EAN 4047728**064521**

Shock absorber tool set

- Professional repair work on spring struts (counterholding the piston rod when removing and installing)
- Operation of shock absorbing nuts on strut bearings
- For the most common vehicle types
- Contents:
 - Open reversible ratchet, size 21 mm, 12-point
 - Open 6-point sockets:
 - 12.5 mm (1/2"), SW 16 · 17 · 18 · 19 · 21 · 22 · 24 mm
 - 12.5 mm (1/2") screwdriver socket, size 6 · 7 · 8 mm
 - 12.5 mm (1/2") extension: 250 mm
 - 12.5 mm (1/2") sockets, oval 5x8 mm, 6x8 mm



VIGOR No.	Designation	Design	EAN 4047728+	€
V6452-1	Reversible ratchet · open		075220	48.90
V6452-5	Socket special profile · MERCEDES-BENZ · 5 mm		075206	19.90
V6452-6	Socket special profile · MERCEDES-BENZ · 6 mm		075213	19.90
V6452-16	Socket · 16 mm		075091	6.90
V6452-17	Socket · 17 mm		075107	7.20
V6452-18	Socket · 18 mm		075114	7.40
V6452-19	Socket · 19 mm		075121	7.80
V6452-21	Socket · 21 mm		075138	8.20
V6452-22	Socket · 22 mm		075145	8.90
V6452-24	Socket · 24 mm		075152	9.90
V6452-250	Sliding T-handle · 250 mm		075169	13.90
V6452-H6	6-point socket · 6 mm		075176	12.90
V6452-H7	6-point socket · 7 mm		075183	12.90
V6452-H8	6-point socket · 8 mm		075190	12.90



185.50 €
excl. VAT

V6956, EAN 4047728069564

Universal axle lever

- Proper, careful installation and removal of axle components such as ball joints and wishbones for example
- Chain adjustment enables flexible use and adaptation to different dimensions and circumstances
- High quality spindle ensures easy working and a high transmission of force
- Direct use on the vehicle without requiring a second person
- Rubber-insulated supporting surface ensures secure hold on the vehicle
- Makes it possible to operate with reversible ratchet or air ratchet

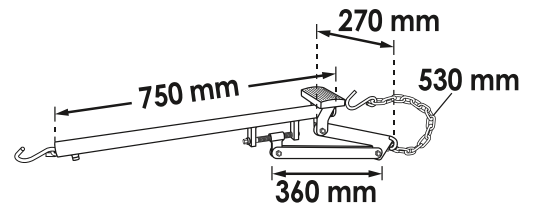

275.- €
excl. VAT

V4642, EAN 4047728046428

Cardan shaft puller · universal

- Proper disassembly of the homokinetic joint and the rubber boots of the drive shaft
- Extra-wide frame, also for large hinges

Specially shaped clamping jaws ensure a secure grip on the drive shaft

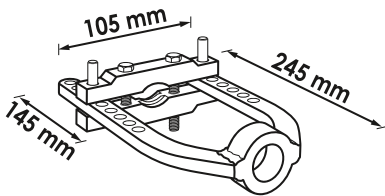

max. Ø 31.5 mm



115.50 €
excl. VAT

Motor vehicles chassis – Various



V7525, EAN 4047728075251

Universal pressing support

- Removal and installation of bearings and bushings together with workshop presses
- Optimised three-point alignment of workpieces on the workshop press
- Extensive adjustability allows almost all workpieces to be aligned parallel to the workshop press, thus increasing safety during use
- Lateral stop position for a secure hold on the workshop press
- Swivel base enables quick and easy positioning on the base
- Maximum permitted loading capacity: 20 tonnes

MADE IN GERMANY



NEW



399.- €
excl. VAT



Motor/commercial vehicle chassis specialty tools

Pressure and tension cylinders	332-334
Cylinder accessories	335-339
Mechanical drive	338-339 368-371
Hydraulic pumps	340
Standard wheel bearing tool sets	341-343
Compact wheel bearing tool sets	344
Screwed compact wheel bearing tool sets	345-353
Wheel hub tool sets with 6 and 8 bolts	353
Drive shaft tool sets	354
Multiboxes	356-367
Bearing and bushing tool sets	372-381
Safety spring vice	382-385
Mobile work benches with specialty tool assortment	386-391
Special soft foam inserts	392-397
Commercial vehicle tool sets	398-417

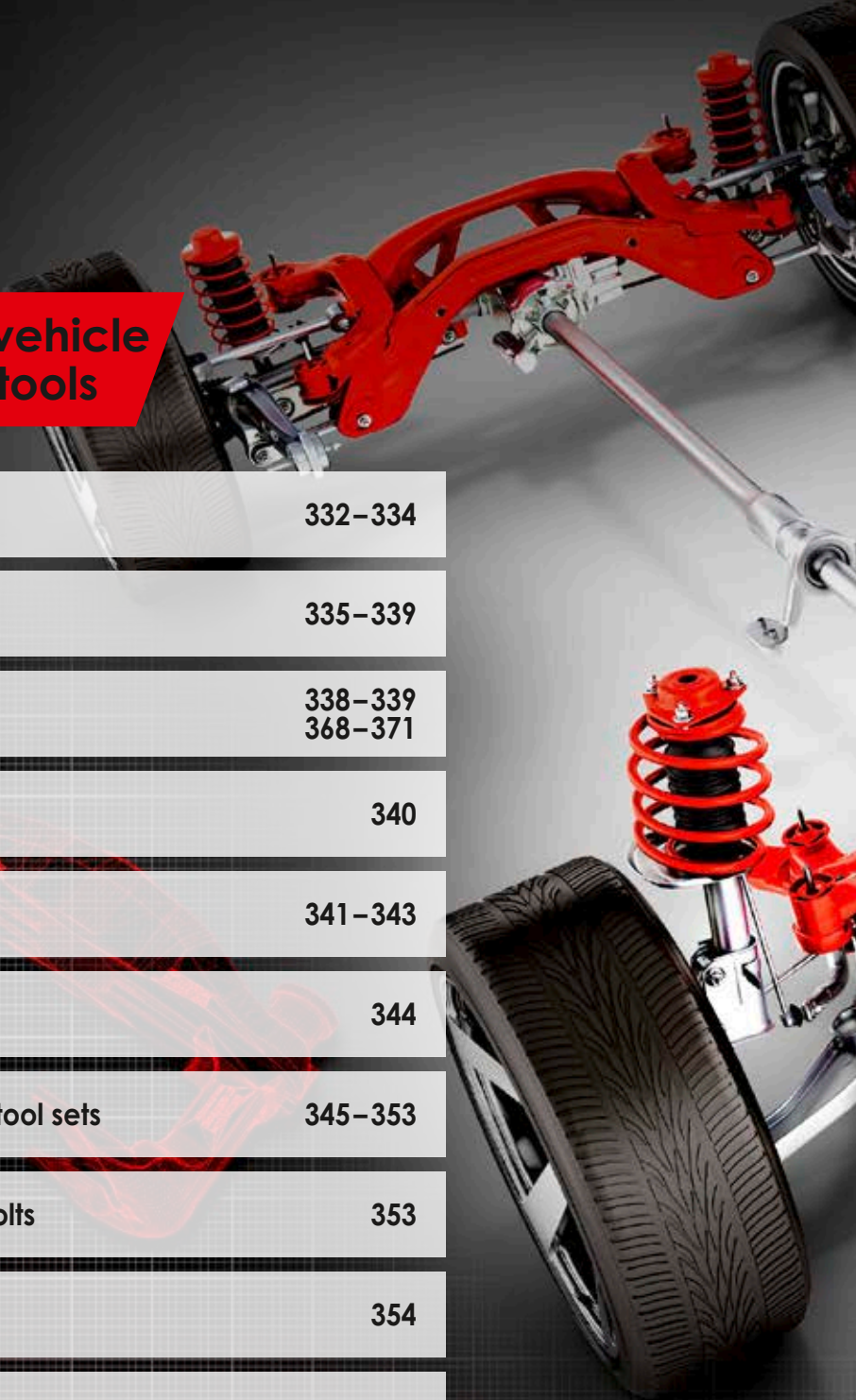



Your specialist for chassis tools



V2873, EAN 4047728028738

Tractive and compressive hydraulic cylinder 8.5 tonnes

- Removing support joints and bushes
- For operation in areas with restricted access
- Thrust rod adjustable

Automatic piston return

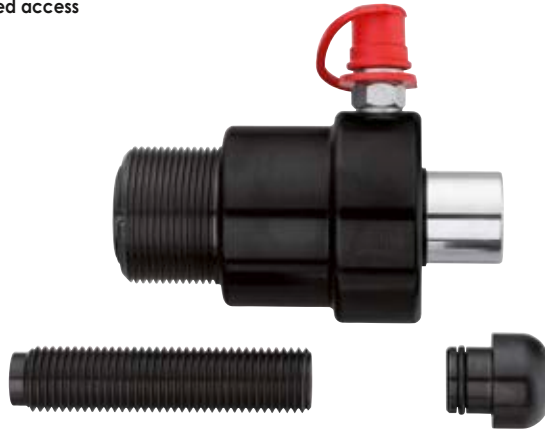

508.50 €
excl. VAT

VIGOR No.	Designation	Design	l mm	EAN 4047728+	€
V3012	CEJN fitting hydraulic · 1/8 inch		-	030120	68.56
V3009	Hydraulic cylinder 8.5 tonnes		-	030090	519.50
V3011	Thrust rod · adjustable M 22		100	030113	70.72
V3010	Impact body with o-ring		-	030106	58.64

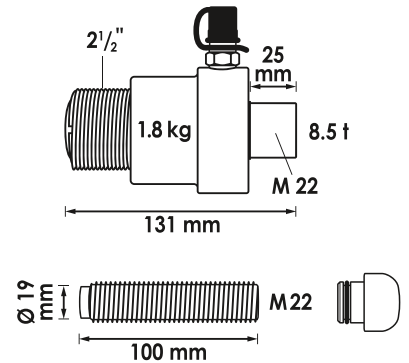

V2869, EAN 4047728028691

Hydraulic cylinder 14 tonnes

- Removing support joints and bushes
- Especially for use with the press frames V2885 and V2858N

Automatic piston return

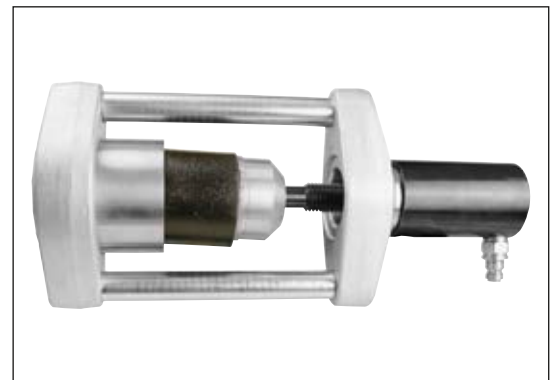

453.- €
excl. VAT

VIGOR No.	Designation	Design	l mm	EAN 4047728+	€
V3128	(CEJN) fitting, hydraulic		-	031288	85.49
V3217	Hydraulic cylinder 14 tonnes		-	032179	447.50
V3124	Thrust rod · adjustable M 24		92	031240	75.14

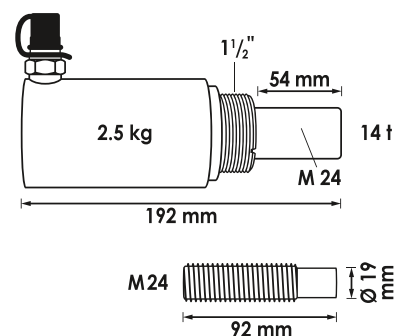

Pressure and tension cylinders



V4551, EAN 4047728**045513**

Tractive and compressive hydraulic cylinder 18 tonnes

- Removing rusted drive shafts
- Pressure of the hydraulic cylinder may be combined with impact force when using an impact body
- To be used with all tools for passenger cars and drawbars M 10 – M 22 with an appropriate reducer

Automatic piston return



861.50 €
excl. VAT



VIGOR No.	Designation	Design	l mm	EAN 4047728+	€
V3128	(CEJN) fitting, hydraulic		-	031288	85.49
V4552	Hydraulic cylinder · 18 tonnes · without accessories		-	045520	668.50
V3125	Protection ring for thread 1.1/2"		-	031257	41.83
V3127	Drawbar · M 18 M 22 · maximum 22 t		250	031271	69.75
V3123	Pressure foot M 24 x 3 mm		-	031233	29.21
V3124	Thrust rod · adjustable M 24		92	031240	75.14
V4553	Pressure shaft · M 24x3 mm		-	045537	11.32
V3126	Flange nut · M 18x2.5		-	031264	41.83
V3018	Impact body · M 22x2.5 mm		-	030182	88.40
V3129	Thrust block · adjustable M 24		132	031295	75.89

Extra light:
only 2.8 kg

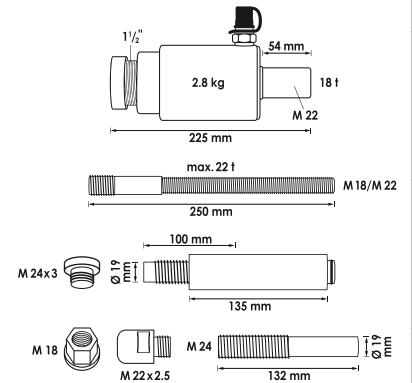

V2854, EAN 4047728**028547**

Tractive and compressive hydraulic cylinder 22 tonnes

- Removing rusted drive shafts
- Pressure of the hydraulic cylinder may be combined with impact force when using an impact body
- To be used with all tools for passenger cars and drawbars M 10 – M 22 with an appropriate reducer

Automatic piston return



883.- €
excl. VAT



VIGOR No.	Designation	Design	l mm	EAN 4047728+	€
V3128	(CEJN) fitting, hydraulic		-	031288	85.49
V3199	Hydraulic cylinder 22 tonnes		-	031998	746.-
V3125	Protection ring for thread 1.1/2"		-	031257	41.83
V3127	Drawbar · M 18 M 22 · maximum 22 t		250	031271	69.75
V3126	Flange nut · M 18x2.5		-	031264	41.83
V3124	Thrust rod · adjustable M 24		92	031240	75.14
V3134	Pressure shaft M 24x3 mm		151	031349	79.88
V3123	Pressure foot M 24 x 3 mm		-	031233	29.21
V3018	Impact body · M 22x2.5 mm		-	030182	88.40
V3130	Thrust block · adjustable M 24		109	031301	75.89

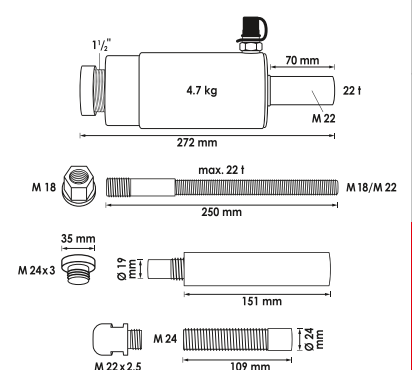

V2874, EAN 4047728**028745**

Tractive and compressive hydraulic cylinder 32 tonnes

- Removing rusted drive shafts and king pins
- Pressure of the hydraulic cylinder may be combined with impact force when using an impact body
- To be used with all tools for passenger cars and drawbars M 10 – M 22 with an appropriate reducer



Automatic piston return

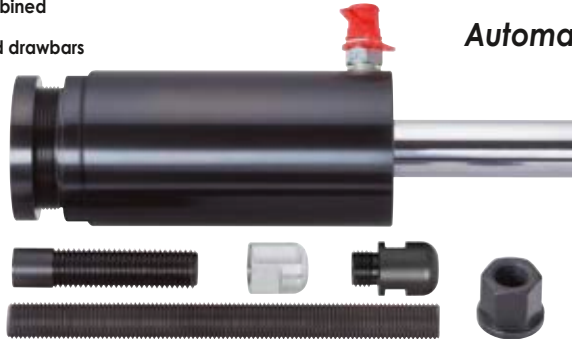

1,137.- €
excl. VAT

VIGOR No.	Designation	Design	l mm	EAN 4047728+	€
V3128	(CEJN) fitting, hydraulic		-	031288	85.49
V3216	Hydraulic cylinder 32 tonnes		-	032162	1,004.-
V3131	Protection ring for thread 2.5		-	031318	58.97
V3130	Thrust block - adjustable M 24		109	031301	75.89
V3092	Striker nut		-	030922	87.43
V3018	Impact body - M 22x2.5 mm		-	030182	88.40
V3133	Drawbar - M 22 - maximum 32 t		250	031332	62.09
V3132	Flange nut - M 22x2.5		-	031325	57.03

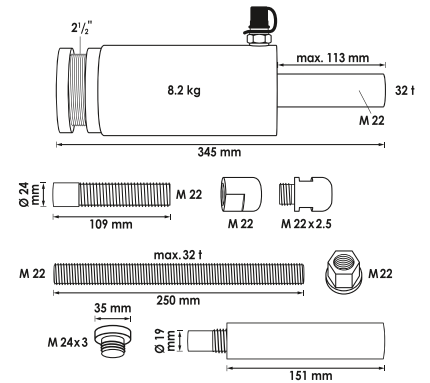

V4229, EAN 4047728**042291**

Tractive and compressive hydraulic cylinder 45 tonnes

- Removing rusted drive shafts
- Pressure of the hydraulic cylinder may be combined with impact force when using an impact body



Automatic piston return

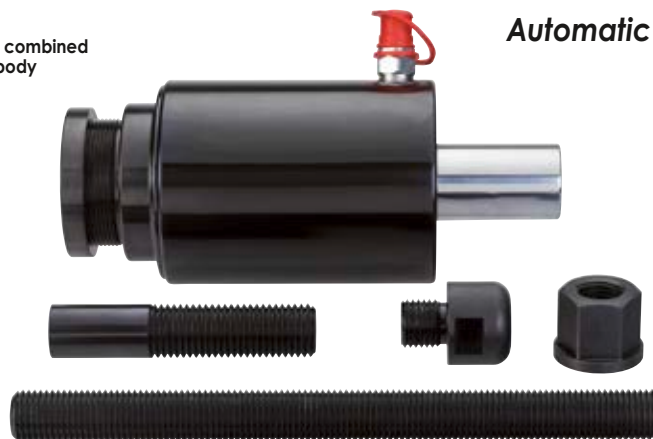

1,712.- €
excl. VAT

VIGOR No.	Designation	Design	l mm	EAN 4047728+	€
V3128	(CEJN) fitting, hydraulic		-	031288	85.49
V4242	Hydraulic cylinder 45 tonnes		-	042420	1,568.-
V3131	Protection ring for thread 2.5		-	031318	58.97
V4251	Thrust block - adjustable - M 30		145	042512	157.-
V4254	Impact body - M 27		-	042543	91.31
V4252	Flange nut M 27		-	042529	120.50
V4253	Drawbar - M 27 - maximum 50 t		330	042536	120.50

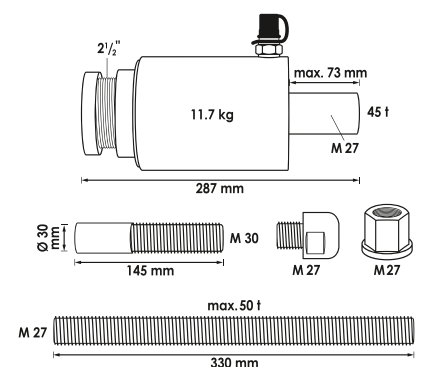

V4218, EAN 4047728**042185**

Support set for hydraulic cylinders

- Use as hand-held bit holders or with transmission jacks
- For all standard transmission jacks with \varnothing of 25 and 30 mm
- For hydraulic cylinder V2869 (14 tonnes) · V2855 (16 tonnes) · V4551 (18 tonnes) · V2854 (22 tonnes) · V2874 (32 tonnes)
- Also for hydraulic cylinders with 65 – 100 mm \varnothing (e.g. Paschke Profitec, Klann)
- Trouble-free adjustment and fixation of the hydraulic cylinder enables flexible and fast handling when working directly on the vehicle



Delivery without hydraulic cylinder



VIGOR No.	Designation	Design	EAN 4047728+	€
V4244	Clamp \varnothing 70 mm		042444	18.43
V4245	Clamp \varnothing 85 mm		042451	18.43
V4246	Clamp \varnothing 100 mm		042468	18.43
V4243	Bracket without shell		042437	220.-

226.50 €
excl. VAT



V3207, EAN 4047728032070

Set of drawbars, flange nuts and adapters



VIGOR No.	Designation	Design	← L → mm		EAN 4047728+	€
V3210	Drawbar · M 10 · maximum 6 t		150	1	032100	38.16
V3220	Drawbar · M 12 · maximum 9 t		250	1	032209	38.16
V3136	Drawbar · M 14 · maximum 12 t		250	1	031363	49.59
V3127	Drawbar · M 18 M 22 · maximum 22 t		250	1	031271	69.75
V3133	Drawbar · M 22 · maximum 32 t		250	1	031332	62.09
V3209	Adapter · M 22x2.5 – M 10x1.5		-	1	032094	38.16
V3219	Adapter · M 22x2.5 – M 12x1.75		-	1	032193	38.16
V3135	Adapter · M 22x2.5 – M 14x2.0		-	1	031356	37.95
V3275	Flange nut · M 10x1.5		-	1	032759	19.40
V3208	Flange nut · M 12x1.75		-	1	032087	33.20
V3137	Flange nut · M 14x2.0		-	2	031370	37.95
V3126	Flange nut · M 18x2.5		-	1	031264	41.83
V3132	Flange nut · M 22x2.5		-	1	031325	57.03

504.50 €
excl. VAT



V2850, EAN 4047728028509

Adapter

- Adaptation of Klann hydraulic cylinder 17 tonnes to VIGOR specialty tools
- Adapter 2.1/4" – 14 UNS (Klann thread) on 1.1/2"

VIGOR No.	Designation	Design	EAN 4047728+	€
V4596*	Adapter · M 18 – M 22		045964	79.13
V4597*	Adapter · M 27 – M 22		045971	24.36
V4342*	Striker nut · M 18		043427	88.40

* Not included in set

71.90 €
excl. VAT



V2851, EAN 4047728028516

Adapter

- Adaptation of VIGOR hydraulic cylinder (8.5 tonnes to 22 tonnes) to KLANN specialty tools
- Adapter 2.1/4" - 14 UNS (Klann thread) on 1.1/2"

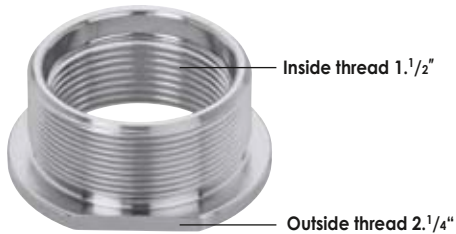

60.80 €

V2910, EAN 4047728029100

Adapter

- Adaptation of hydraulic cylinders 16 tonnes (V2855) and 22 tonnes (V2854) to the VIGOR specialty tool with 1.1/2" thread
- Adapter 1.1/2" to 2.1/2" - 11 UNS

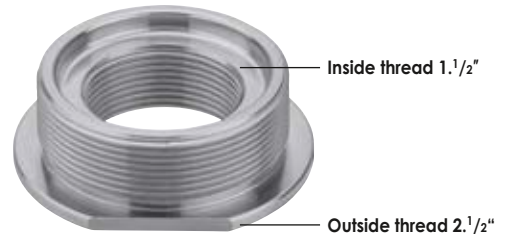

60.80 €

V3869, EAN 4047728038690

Adapter

- Adaptation of VIGOR hydraulic cylinder to Paschke Profitec specialty tools
- Adapter M 68x2 mm (Paschke Profitec thread) on 1.1/2"



60.80 €

V4220, EAN 4047728042208

Adapter

- Adaptation of Klann hydraulic cylinder 28 tonnes to VIGOR specialty tools
- Adapter 2.3/4" - 14 UNS (Klann thread) on 2.1/2"



60.80 €

V3582, EAN 4047728035828

Protective cover

- Protection while working with hydraulic cylinders together with specialty tools



242.- €

V3612, EAN 4047728036122

Manometer

- Connecting piece and fitting for direct coupling to all VIGOR hydraulic pumps
- For information concerning the maximum pressure range of the hydraulic cylinders, see the respective operating instructions



315.- €

V6592, EAN 4047728065924

Adapter 3/8" inside thread · on CEJN / pump

- Adapting e.g. Klann or Sauer hydraulic pumps to the CEJN connection
- Quick, easy connection
- Non-drip, without oil loss
- Protects system against ingress of air
- CEJN connections are smaller than standard connections - for areas with restricted access
- Flexible and easy locking without distortion

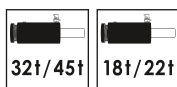

54.22 €

V6591, EAN 4047728065917

Adapter 3/8" outside thread · on CEJN / cylinder

- Adapting e.g. Klann or Sauer hydraulic cylinders to the CEJN connection
- Quick, easy connection
- Non-drip, without oil loss
- Protects system against ingress of air
- CEJN connections are smaller than standard connections - for areas with restricted access
- Flexible and easy locking without distortion

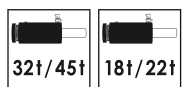

54.22 €



V2853, EAN 4047728028530

Spindle set · mechanical

- Mechanical spindle for tool sets · V2865 · V2845 · V2848 · V2860 · V2870 · V4491 · V4629 · V2860 · V3731 and V3732
- 330 mm length is sufficient for almost all work to be performed



237.50 €
excl. VAT

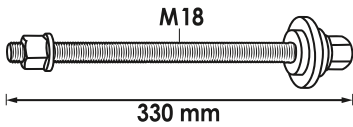

VIGOR No.	Designation	Design	L mm	EAN 4047728+	€
V3126	Flange nut · M 18x2.5		-	031264	41.83
V3008	Drawbar with flange nut M 18		330	030083	120.50
V3206	Washer		-	032063	17.68
V3205	Thrust washer		-	032056	99.50



V4699, EAN 4047728046992

Pressure spindle set · manual

- Manual pressure spindle set for mechanical operation of specialty tools
- Included in the set are four thrust rods of varying lengths with which the use of different tools is guaranteed
- Use with V3072 · V2858N · V3147 · V3649 · V3148 · V2885 · V2920 and V2937
- Spindle and adapter are designed especially for pneumatically supported operation, making work with an impact wrench up to a maximum of 1000 Nm tightening torque possible, for example
- Effective transfer of spindle forces is at a maximum of 15 tonnes
- In the case of frequent work with supporting joints, bushes and drive shafts, we recommend using the 8.5 – 22 tonne hydraulic cylinder



342.50 €
excl. VAT

VIGOR No.	Designation	Design	EAN 4047728+	€
V4699-3	Washer Ø 18.8x3 mm (4 pcs)		047029	54.87*
V4699-4	Press axle · 50xØ 19 mm		047036	35.47
V4699-5	Press axle · 85xØ 19 mm		047043	35.47
V4699-6	Press axle · 56xØ 24 mm		047050	35.47
V4699-7	Press axle · 100xØ 24 mm		047067	47.86
V4699-1	Pressure spindle · M 30		047005	169.-
V4699-2	Adapter · 1.1/2" · M 30		047012	72.87



* Price per set

V2867, EAN 4047728028677

Circlip tool

- Facilitates the removal of frequently rusted circlips located in the inside of wheel bearings
- Maximum force and fast removal due to adjusting screw with recesses for a 6.3 mm (1/4") ratchet
- For passenger cars, vans and trucks
- Unique construction always ensures the right angle of the pin regardless of the size of the circlip
- Simpler, faster pin replacement



Spare pins for V2867

VIGOR No.	Designation		EAN 4047728+	€
V2992	Pin Ø 2.5 mm	4	029926	32.02*
V2993	Pin Ø 3.0 mm	4	029933	32.02*
V2994	Pin Ø 3.5 mm	4	029940	32.02*

* Price per set

160.50 €
excl. VAT

V2927, EAN 4047728029278

Scraper

- Removing rust from the outer edge of the brake discs as well as from the brake calliper lining
- We recommend using crank V2928 to turn the brake disc during the cleaning process



61.12 €
excl. VAT

V2928, EAN 4047728029285

Crank for brake disc

- Removal of rust from the outer edge
- Turning the brake disc when using scraper V2927



30.18 €
excl. VAT



Hydraulic pumps



V2846, EAN 4047728028462
Hydraulic pump · pneumatic
 • For all hydraulic cylinders
 • Including oil dipstick

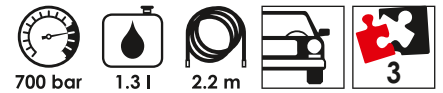

Design including manometer

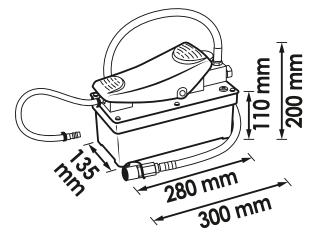

807.50 €
excl. VAT

VIGOR No.	Designation	Design	EAN 4047728+	€
V3120	Hydraulic hose		031202	188.50
V3141	(CEJN-) quick coupler connection		031417	138.-
V4255	Manometer		042550	83.98

V2847, EAN 4047728028479
Hydraulic foot pump
 • For all hydraulic cylinders

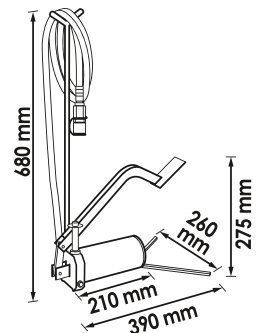

581.- €
excl. VAT

VIGOR No.	Designation	Design	EAN 4047728+	€
V3120	Hydraulic hose		031202	188.50
V3614	Gasket set		036146	45.71
V3141	(CEJN-) quick coupler connection		031417	138.-

Standard wheel bearing tool sets



V4629, EAN 4047728**046299**

Wheel hub removal tool · universal

- Effective method for disassembling wheel hubs.
Recommendation: Use wheel bearing tool set V4598
- Functions also with steering knuckles with uneven and limited surfaces
- Significant time savings compared to earlier systems

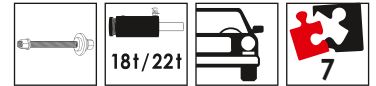

VIGOR No.	Designation	Design		EAN 4047728+	€
V3873	Fixing screw · M 14		2	038737	48.29*
V3874	Bolt · M 12		2	038744	22.96*
V3871	Cross beam for various pressure feet		1	038713	234.-
V4629-1	Pressure foot set for V4629		2	046305	342.50**

518.50 €
excl. VAT

* Price per piece ** Price per set

V2845, EAN 4047728**028455**

Hub and bearing shell

- For wheel bearing and hub on e.g.:
 - FORD: C-Max
 - MAZDA: 3
 - Volvo: S40 · V50
 - ŠKODA: Octavia 1996 → 2004
 - VW: Golf 4 · Bora · Beetle
 - AUDI: A3 · S3 · TT 1999 → 2006
 - SEAT: León 1 · Toledo 2
- As well as for certain models from CITROËN · PEUGEOT · RENAULT and VAG with separated wheel bearing/hub
- (Note: normal press frame is not suitable)
- To be used with V4629



VIGOR No.	Designation	Design	mm	EAN 4047728+	€
V3040	Pressure pipe · large		120	030403	168.-
V3039	Thrust washer · large		-	030397	102.50



182.50 €
excl. VAT

V3072, EAN 4047728**030724**

Press frame

- Special shape: for steering knuckles with flat support on the front
- In conjunction with V4551 or V2854
- Maximum loading capacity: 22 t

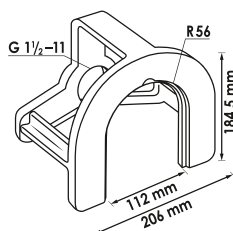

453.- €
excl. VAT



V4598, EAN 4047728**045988**

Wheel bearing, hub tool and drive shaft set · universal

- Allows the wheel bearings to be changed directly on the vehicle with minimum time spent
- Together with hydraulic cylinder or manual spindle
- All parts are adapted for the wheel bearing sizes currently found on the market
- The mounting washers have a guide and are usable on both sides
- Mounting washers with $\varnothing 62 - 83$ mm and support discs of $34 - 60$ mm are included, the bearing shell is for wheel bearings of up to $\varnothing 92$ mm
- Removal of the wheel hub with V4629 · V2849 and V3072
- Working time: approx. 20 – 30 minutes per side
- Wheel alignment and brake bleeding not necessary
- Not necessary to remove the ABS sensor, steering knuckle, strut or steering tie rod



VIGOR No.	Designation	Design	mm	EAN 4047728+	€
V4598-30	Pressure pipe length 78 mm for V4598 · V4599		78	046282	58.86
V4598-22	Bearing shell $\varnothing 93$ mm for V4598		-	046275	58.86
V4598-21	Bearing shell $\varnothing 75.5$ mm for V4598		-	046268	58.86
V4598-20	Bearing shell $\varnothing 93$ mm for V4598		-	046251	113.-
V4598-10	Bearing washer $\varnothing 61.8 - 62.8$ mm · inside hole $\varnothing 20.25$ mm · suitable for spindle M 20		-	046183	65.87
V4598-11	Bearing washer $\varnothing 63.8 - 64.8$ mm · inside hole $\varnothing 20.25$ mm · suitable for spindle M 20		-	046190	65.87
V4598-12	Bearing washer $\varnothing 65.8 - 66.8$ mm · inside hole $\varnothing 20.25$ mm · suitable for spindle M 20		-	046206	65.87
V4598-13	Bearing washer $\varnothing 68.8 - 70.8$ mm · inside hole $\varnothing 20.25$ mm · suitable for spindle M 20		-	046213	69.53
V4598-14	Bearing washer $\varnothing 72.5 - 74.5$ mm · inside hole $\varnothing 20.25$ mm · suitable for spindle M 20		-	046220	69.53
V4598-15	Bearing washer $\varnothing 76.5 - 78.5$ mm · inside hole $\varnothing 20.25$ mm · suitable for spindle M 20		-	046237	69.53
V4598-16	Bearing washer $\varnothing 80.8 - 82.8$ mm · inside hole $\varnothing 20.25$ mm · suitable for spindle M 20		-	046244	72.98
V3060	Counterholder		-	030601	94.-
V4614	Support disc · tapered · $\varnothing 33.8$ mm · for V4598		-	046145	20.37
V4598-2	Support disc · tapered · $\varnothing 38.8$ mm · for V4598		-	046152	23.82
V4598-3	Support disc · tapered · $\varnothing 43.8$ mm · for V4598 · V4599		-	046169	28.24
V4598-4	Support disc · tapered · $\varnothing 59.8$ mm · for V4598		-	046176	36.87



629.- €
excl. VAT

Standard wheel bearing tool sets



V4599, EAN 4047728**045995**

Wheel bearing tool set AUDI Q7 · VW Touareg · PORSCHE Cayenne

- Wheel bearings change on the front axle
- On AUDI Q7 · VW Touareg · PORSCHE Cayenne
- Changing the wheel bearing on the rear axle on AUDI Q7
- Shape of tool prevents damaging of ABS sensor
- Addition to removal of wheel hub: V4629
- Addition to removal of wheel bearing: V2860
- Reduces the time spent to approx. 30 minutes
- Wheel bearings can be changed directly on the vehicle without time-consuming disassembly

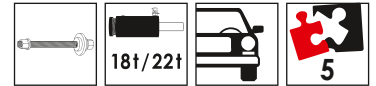

VIGOR No.	Designation	Design	← L → mm	EAN 4047728+	€
V3071	Bearing washer Ø 95 mm · inside hole Ø 20.25 mm · suitable for spindle M 20		-	030717	89.26
V4598-30	Pressure pipe length 78 mm for V4598 · V4599		78	046282	58.86
V3070	Bearing washer Ø 92 mm		-	030700	84.73
V4598-12	Bearing washer Ø 65.8 – 66.8 mm · inside hole Ø 20.25 mm · suitable for spindle M 20		-	046206	65.87
V4598-3	Support disc · tapered · Ø 43.8 mm · for V4598 · V4599		-	046169	28.24

304.- €
excl. VAT

V4594, EAN 4047728**045940**

Wheel bearing fixation, adjustable

- Wheel bearings, removed to the inside
- The plate allows optimum adjustment to an inclined or uneven surface on the inside, forming an even pressing surface
- Use with hydraulic cylinder, mechanical spindle or workshop press
- To be used with V4629
- Disassembly of the wheel bearing with V4598
- On e.g.
 - CITROËN: Berlingo (model year 1996 →), Jumpy (model year 1995 →)
 - RENAULT: Clio (model year 1991 → 2012)
 - FIAT: Scudo (model year 1995 →)
 - PEUGEOT: Partner (model year 1996 →), Expert (model year 1995 →)
 - KIA: Rio (2001 → 2005), Ceéd (2006 → 2012)
 - HYUNDAI: i30 (model year 2007 →)

Universal fixation for all bearings to be removed backwards



VIGOR No.	Designation	Design		EAN 4047728+	€
V4594-1	Pressure foot set for V4594		2	045957	264.-*
V3060	Counterholder		1	030601	94.-

308.50 €
excl. VAT

* Price per set



V2860, EAN 4047728028608

Compact wheel bearing removal set · universal

- Removing compact wheel bearings with or without circlip
- For e.g.:
 - VW: Polo · Lupo · Touareg · Fox · T5 front and rear · Crafter
 - AUDI: A2
 - SEAT: Ibiza · Córdoba
 - ŠKODA: Fabia · Rapid · Roomster
 - FORD: Focus · C-Max · Mondeo · S-Max · Kuga
 - LANDROVER: Freelander 2
 - MAZDA: 3 · 5 · 6 · CX-7
 - MERCEDES-BENZ: Sprinter · Vito · Viano
 - MITSUBISHI: Colt
 - SMART: Forfour
 - Volvo: V50 · S40 · V70 · S80 · XC60
 - BMW: 3 F30/F31 (2012 → 2015) · 3 E90/E91 SED/TOU (2005 → 2012)
 - BMW: 1 F20/F21 (2011 → 2015) · 1 E82/E88 Coupé/CAB (2006 → 2015) · 1 E87/E81 5D/3D
- Removal of the wheel hub on passenger cars
- Enables use with mechanical spindle



Adjustability guarantees use of all types of current and future compact wheel bearings available on the market



VIGOR No.	Designation	Design		EAN 4047728+	€
V3873	Fixing screw · M 14		2	038737	48.29*
V3874	Bolt · M 12		2	038744	22.96*
V3871	Cross beam for various pressure feet		1	038713	234.–
V3755	Pressure foot set (removal) for compact wheel bearings		2	037556	340.50**

* Price per piece ** Price per set

505.50 €
excl. VAT

V2864, EAN 4047728028646

Thrust washer · conical · universal

- Conical washer for the removal of compact wheel bearings



Inside diameter 20.25 mm
suitable for M 20 spindle

Suitable for all sizes

44.20 €
excl. VAT

V6824, EAN 4047728068246

Half shell set for assembling 92 mm compact wheel bearings

- For changing the wheel bearings directly on the vehicle without removal of the steering knuckle
- Professional installation using a special adapter ring prevents inner damage on the compact wheel bearing due to improper installation and pressure on the wheel hub
- Removal of the wheel bearing also possible together with the tools V2860 · V2864 · V5027
- Installation with tools V4491 and V2862
- Hydraulic or manual drive tools are also required
- For, among others:
 - PEUGEOT Expert · Traveller model year 2016 →
 - CITROËN Spacetourer model year 2016 →
 - TOYOTA Proace · Proace Verso model year 2016 →



109.50 €
excl. VAT

Screwed compact wheel bearing tool sets



V3731, EAN 4047728037310

Removal set, universal, for screwed wheel bearing unit

- Removing screwed wheel bearing units (4 bolts) at the front and rear axle
- Usage of the pressure feet on both sides ensures quick and easy adjustment at the steering knuckle
- Maximum loading capacity: 22 tonnes
- Adjustability guarantees usage with all models of screwed wheel bearing units with 4 bolts currently available on the market
- Can be used directly on the vehicle
- For: VAG · FORD · MAZDA · TOYOTA · MITSUBISHI · AUDI A4 · A6 · VW Passat · ŠKODA Octavia · SEAT Exeo etc.



Universally adjustable for screwed wheel bearing units with 4 bolts

VIGOR No.	Designation	Design		EAN 4047728+	€
V3873	Fixing screw · M 14		2	038737	48.29*
V3874	Bolt · M 12		2	038744	22.96*
V3871	Cross beam for various pressure feet		1	038713	234.-
V3758	Pressure foot set (removal) for screwed wheel bearing units		2	037587	342.50**

* Price per piece ** Price per set

508.50 €
excl. VAT

V3732, EAN 4047728037327

Removal set, universal, for screwed wheel bearing unit

- Removing screwed wheel bearing units (3 bolts) at the front and rear axle
- Usage of the pressure feet on both sides ensures quick and easy adjustment at the steering knuckle
- Maximum loading capacity: 22 tonnes
- Adjustability guarantees usage with all models of screwed wheel bearing units with 3 bolts currently available on the market
- Can be used directly on the vehicle
- For e.g.:
 - VW Golf 6 convertible model years 2013 → · Golf model years → 2012 · Touran model years 2015 → · Tiguan model years 2016 → · Passat model years 2014 →
 - AUDI A3 model years 2012 → · TT model years 2014 → · Q2 model years 2016 →
 - ŠKODA Octavia model years 2012 → · Superb model years 2015 →
 - SEAT León model years 2012 →
 - OPEL/VAUXHALL Insignia · Astra model years 2004 → · Corsa D → 2014
 - CHEVROLET/GMC Malibu
 - SAAB 95 model years 2010 →



Universally adjustable for screwed wheel bearing units with 3 bolts

VIGOR No.	Designation	Design		EAN 4047728+	€
V3873	Fixing screw · M 14		2	038737	48.29*
V3874	Bolt · M 12		2	038744	22.96*
V3871	Cross beam for various pressure feet		1	038713	234.-
V3753	Pressure foot set (removal) for screwed wheel bearing units		2	037532	342.50**

* Price per piece ** Price per set

508.50 €
excl. VAT



V5420, EAN 4047728075275

ROVER standard wheel bearing removal and installation set

- Removal and installation of wheel bearings and wheel hubs on ROVER
- Specially adapted extension feet for stable and damage-free grip on the steering knuckle
- Recesses on thrust washer – ABS sensors remain untouched and do not need to be replaced
- With adapter plate for loosening the circlip
- For e.g.: Land Rover Discovery Sport L494 2013 → 2019 · Defender L663 2020 → · Discovery Sport L550 2019 → · Discovery 5 L462 2017 → · Range Rover Sport L494 2013 → · Vogue L405 2012 → · Evoque L538 2011 → · Velar L560 2017 →



NEW



999.- €
excl. VAT

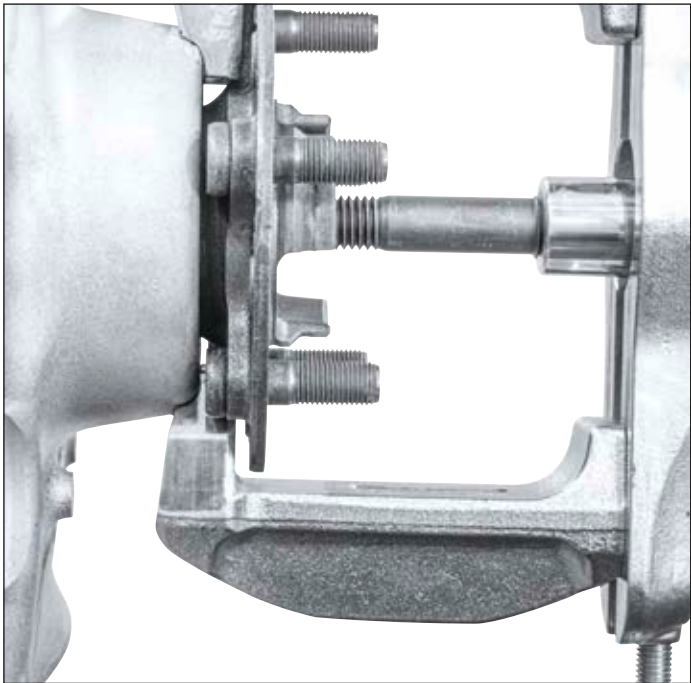
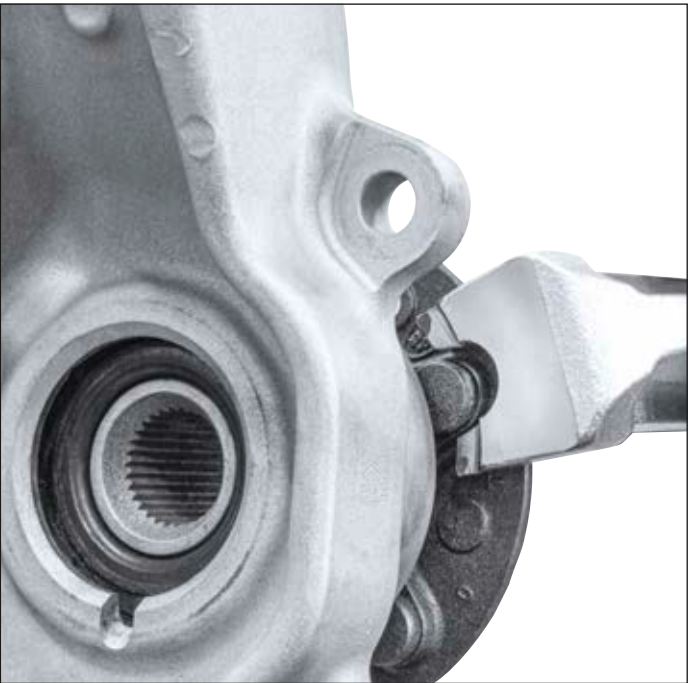
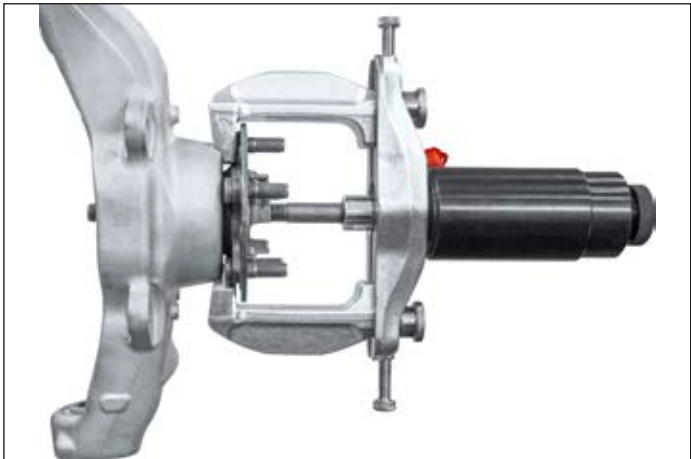

Screwed compact wheel bearing tool sets



V5425, EAN 4047728075596

ROVER standard wheel bearing expansion set

- Removal and installation of wheel bearings and wheel hubs on ROVER
- Specially adapted extension feet for stable and damage-free grip on the steering knuckle
- Recesses on thrust washer – ABS sensors remain untouched and do not need to be replaced
- With adapter plate for loosening the circlip
- For e.g.:
Land Rover Discovery Sport L494 2013 → 2019 · Defender L663 2020 → · Discovery Sport L550 2019 → · Discovery 5 L462 2017 → Range Rover Sport L494 2013 → · Vogue L405 2012 → · Evoque L538 2011 → · Velar L560 2017 →
- For front and rear axle
- Note: crossbar V3871 including screw connections required for complete machining



NEW

599.- €
excl. VAT

V5421, EAN 4047728075282

Expansion set

- Removal and installation of wheel bearings and wheel hubs on ROVER
- Specially adapted extension feet for stable and damage-free grip on the steering knuckle
- Recesses on thrust washer – ABS sensors remain untouched and do not need to be replaced
- With adapter plate for loosening the circlip
- For e.g.: Land Rover Discovery Sport L494 2013 → 2019 · Defender L663 2020 → · Discovery Sport L550 2019 → · Discovery 5 L462 2017 → Range Rover Sport L494 2013 → · Vogue L405 2012 → · Evoque L538 2011 → · Velar L560 2017 →
- Pressure foot pair



349.- €
excl. VAT

NEW

V5422, EAN 4047728075466

Bearing plate

Ø 85 – 95 mm



NEW

99.- €
excl. VAT

V5423, EAN 4047728075312

Supporting plate

Ø 86 – 105 mm



99.- €
excl. VAT

NEW

V5424, EAN 4047728075329

Bearing plate

Ø 95 mm



NEW

79.- €
excl. VAT



V3865, EAN 4047728**038652**

Wheel bearing unit / compact wheel bearing · screwed · removal set · universal

- Removal of any types of compact wheel bearings as well as screwed wheel bearing units with 3 and 4 bolts
- Universal set for the removal of all screwed wheel bearing units and compact wheel bearings
- Maximum loading capacity 22 tonnes
- Can be used directly on the vehicle

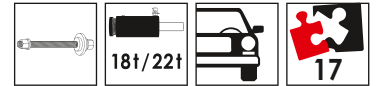

Can be used directly on the vehicle

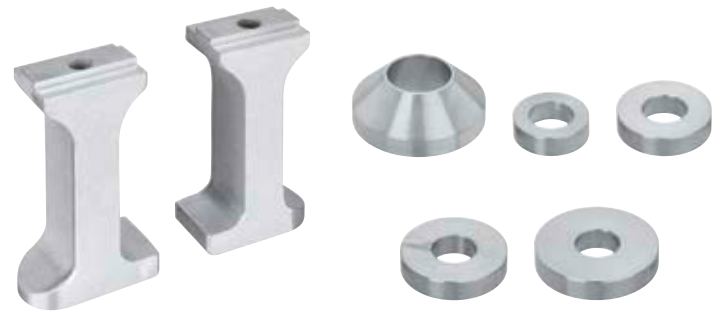
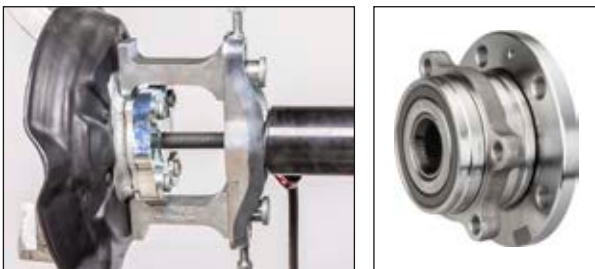

VIGOR No.	Designation	Design		EAN 4047728+	€
V2860	Compact wheel bearing removal set · universal		7	028608	505.50
V3758	Pressure foot set (removal) for screwed wheel bearing units		2	037587	342.50
V3753	Pressure foot set (removal) for screwed wheel bearing units		2	037532	342.50
V2864	Thrust washer · conical · universal		1	028646	44.20
V3033	Support disc Ø 32 mm · inside hole Ø 20.25 mm · suitable for spindle M 20		1	030335	15.20
V3034	Support disc Ø 40 mm · inside hole Ø 20.25 mm · suitable for spindle M 20		1	030342	16.60
V3035	Support disc Ø 45 mm · inside hole Ø 20.25 mm · suitable for spindle M 20		1	030359	19.08
V3036	Support disc Ø 52 mm · inside hole Ø 20.25 mm · suitable for spindle M 20		1	030366	24.04
V3063	Bearing washer Ø 63 mm · inside hole Ø 20.25 mm · suitable for spindle M 20		1	030632	74.06

Universal set for installing and removing all screwed wheel bearing units and compact wheel bearings

1,342.- €
excl. VAT

Screwed compact wheel bearing tool sets



V3866, EAN 4047728**038669**

Wheel bearing unit and compact wheel bearing ·
screwed · removal / assembly tool set · universal

- Installation / removal of all screwed wheel bearing units and compact wheel bearings with 3 or 4 bolts
- Maximum loading capacity 22 tonnes
- Can be used directly on the vehicle

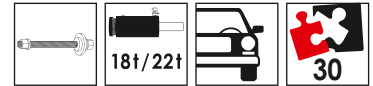

Universal set for the installation and removal of all screwed wheel bearing units and compact wheel bearings



Disassembly



Assembly



VIGOR No.	Designation	Design		EAN	€
V3865	Wheel bearing unit / compact wheel bearing · screwed · removal set · universal		17	038652	1,342.-
V3680	Compact wheel bearing installation set · universal		13	036801	827.50

1,935.- € excl. VAT



V2859, EAN 4047728028592

Thrust washer (installation)
FORD · MAZDA · Volvo

- For e.g.:
 - FORD: Mondeo, Focus, C-Max, S-Max, Kuga
 - MAZDA: 3to6 · 5 · CX7
 - Volvo: V70 model year 2007 →, S40 · V50 model year 2004 →
 - LANDROVER: Freelander 2-14

Inside diameter
 20.25 mm suitable
 for spindle M 20



61.12 €
 excl. VAT

V2863, EAN 4047728028639

Mounting ring FORD · MAZDA · Volvo

- Deeper insertion of the compact wheel bearing into the wheel bearing housing

- For e.g.:
 - FORD: Mondeo · S-Max
 - MAZDA: 6
 - Volvo: V70 model year 2007 → · S80 · V60 · XC60 · XC70



67.48 €
 excl. VAT

V2862, EAN 4047728028622

Thrust washer (installation) VW

- For e.g.:
 - VW: T5 front and rear, Touareg
 - MERCEDES-BENZ: Vito and Viano rear axle

Inside diameter
 20.25 mm suitable
 for spindle M 20

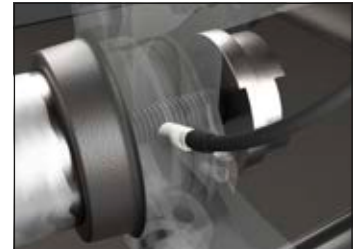

91.95 €
 excl. VAT

V2861, EAN 4047728028615

Thrust washer (installation)
VW · AUDI · SEAT · ŠKODA

- For e.g.:
 - VW: Polo, Lupo, Fox
 - AUDI: A2
 - SEAT: Ibiza, Córdoba
 - ŠKODA: Fabia
 - SMART: Forfour
 - MITSUBISHI: Colt



67.48 €
 excl. VAT

V7061, EAN 4047728070614

Screw set for SUBARU rear wheel bearings

- Removal of rear wheel bearing on the SUBARU using tool V5903N requires longer bearing bolts
- Set consisting of 4 hexagon screws M 12x1.25x100 mm for the bearing thread
- Use washers with flat side facing screw head
- For e.g. SUBARU Legacy · Impreza · Forester · Outback · XV



Wheel bearing puller V5903N optionally available



38.59 €
 excl. VAT

Screwed compact wheel bearing tool sets



V5903N, EAN 4047728075237

Wheel bearing puller

- Removal of screwed wheel bearing units (3 or 4 bolts) at the front and rear axle when the wheel hub is removed
Only together with V3731 and V3732
- Can be used directly on the vehicle
- Maximum loading capacity: 18 tonnes
- For e.g. AUDI A4 model year 2007 → 2016 · A5 model year 2007 → 2017 · A6 model year 2011 → A7 model year 2010 → · A8 model year 2010 → · Q5 model year 2008 →



NEW



VIGOR No.	Designation	Design	EAN 4047728+	€
V5903-3	Drawbar · M 22 · 121 mm		059077	30.62

279.- €
excl. VAT

V5027, EAN 4047728050272

Wheel hub puller

- Removal of screwed wheel bearing units with closed wheel hub
The drive shaft does not have to be removed beforehand anymore
- To be used together with wheel bearing / hub tool V3731 · V3732 · V2860 as well as hydraulic cylinder 16 – 22 tonnes
- Bolt circle 4 and 5-hole: 92 – 131 mm
- Note: Do not load tool with more than 18 tonnes
- For models with closed wheel hub, among others:
 - OPEL Insignia model year 2010 →
 - SAAB 9-5 model year 2010 →
 - CITROËN C1 model year 2006 →
 - Jumpy model year 2016 → · SpaceTourer model year 2016 →
 - PEUGEOT 108 model year 2015 →
 - Expert model year 2016 → · Traveller
 - TOYOTA Aygo model year 2006 → · ProAce (Verso)



Wheel hub removal without removing the drive shaft



226.50 €
excl. VAT



V4491, EAN 4047728**044912**

Compact wheel bearing installation set · universal

- Installation of compact wheel bearings with or without circlip
- Maximum loading capacity: 22 tonnes
- E.g. on:
 - VW: Polo · Lupo · Touareg · Fox · T5 front and rear · Crafter
 - AUDI: A2
 - SEAT: Ibiza · Córdoba
 - ŠKODA: Fabia · Rapid · Roomster
 - FORD: Focus · C-Max · Mondeo · S-Max · Kuga
 - LANDROVER: Freelander 2
 - MAZDA: 3 · 5 · 6 · CX-7
 - MERCEDES-BENZ: Sprinter · Vito · Viano
 - MITSUBISHI: Colt
 - SMART: Forfour
 - Volvo: V50 · S40 · V70 · S80 · XC60
- Use with hydraulic cylinder, mechanical spindle or workshop press



Adjustability guarantees use of all types of current and future compact wheel bearings available on the market

VIGOR No.	Designation	Design		EAN 4047728+	€
V3873	Fixing screw · M 14		2	038737	48.29*
V3874	Bolt · M 12		2	038744	22.96*
V3871	Cross beam for various pressure feet		1	038713	234.–
V4493	Pressure foot (pair) for compact wheel bearing assembly tool set · universal		2	044936	354.50**

* Price per piece ** Price per set

570.50 €
excl. VAT

V7050, EAN 4047728**070508**

Removal tool for screwed 4-hole wheel hubs/wheel bearings with uneven brake guard

- Flexibly adjustable, especially for models with difficult to access brake guard
- Removal directly on the vehicle
- Owing to the effects of corrosion, these wheel bearing types have a very tight fit and are difficult to remove. The use of the tool prevents damage to the steering knuckle parts or brake guard
- For e.g.: SUBARU Forester · XV · Outback
TOYOTA Aygo 2006 → 2019 · Avensis
CITROËN C1
PEUGEOT 107 · 108
OPEL/VAUXHALL Vectra · Zafira
CHRYSLER Voyager
HYUNDAI I10
SUBARU various models



330.50 €
excl. VAT

Screwed compact wheel bearing tool sets

Wheel hub tool sets with 6 and 8 bolts



V5906, EAN 4047728059183

Wheel bearing unit · screwed ·
removal tool set · universal

- Removing screwed wheel bearings with 3 / 4 bolts
- Specially designed pressure feet allow removal of wheel bearings on SUVs and US pickups
- Wheel hubs of sizes up to 180 mm can be removed thanks to the adjustable crossbar
- Heating of components and associated damage is prevented
- Additional use of V5905 does away with the need to remove the drive shaft
- For: DODGE · CHEVROLET/GMC · FORD Ranger model years 2011 →



SUV / van wheel hubs with
6 and 8 stud bolts
Universally adjustable to a
diameter of maximum 180 mm

SUV
Van

18t/22t



VIGOR No.	Designation	Design		EAN 4047728+	€
V3873	Fixing screw · M 14		2	038737	48.29*
V3874	Bolt · M 12		2	038744	22.96*
V3871	Cross beam for various pressure feet		1	038713	234.-
V5906-1	Pressure foot set		2	059190	514.-

* Price per piece

795.50 €
excl. VAT

V5905, EAN 4047728059152

Wheel hub / wheel bearing
puller · for 6 and 8 bolts

- Removing screwed wheel bearings and hub units directly on the vehicle
- Only together with V5906 and V2860
- Removal of a closed wheel hub
- No need to remove the drive shaft
- The included M 22 threaded rods connect the tool to one of our hydraulic cylinders
- For bolt circle (6 hole) 111.5 – 142.5 mm, (8 hole) 162.5 – 182.5 mm

14t/18t
22t

SUV
Van



398.- €
excl. VAT



V5904, EAN 4047728059084

Device for the removal of drive shafts · 6 and 8 holes

- For removing rusted and glued drive shafts directly on the vehicle
- For bolt circle (6 hole) 114 – 140 mm, (8 hole) 165 to 180 mm
- Removal of drive shaft with 22 tonne hydraulic cylinder (installation of the impact body enables use of additional force by using a hammer)
- Fastening with wheel nuts or wheel bolts on the vehicle



Adjustable, suitable for bolt circle (6 hole) from 114 to 140 mm, (8 hole) from 165 to 180 mm

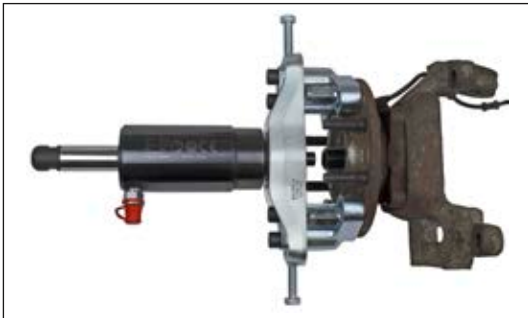

VIGOR No.	Designation	Design		EAN 4047728+	€
V5904-1	Pressure foot set		2	059114	398.-**
V3871	Cross beam for various pressure feet		1	038713	234.-
V5904-3	Sliding plate		4	059138	12.50*
V5904-4	Screw · M 14 × 45 · inside hexagon		2	059145	11.32*

* Price per piece ** Price per set

629.- €
excl. VAT

V7154N, EAN 4047728071772

Extension set for brake disc removal tool without crossbar

- Separates severely rusted brake discs and those that are stuck to the wheel hubs
- Removal tool feet transmit even pressure onto the brake disc
- Even distribution of force via four feet to the brake disc minimises the risk of damage
- Recommendation: use of a hydraulic cylinder, e.g. V4551 or V2854
- Alternative application with V4699
- To be used together with the V3871 crossbar, which is not included but is also required
- including fixing plates, removal tool feet, screws, shims
- Span width: 260 – 330 mm
- Maximum loading capacity: 22 t



662.- €
excl. VAT

Screwed compact wheel bearing tool sets



V7027, EAN 4047728**075244**

Wheel hub / bearing puller

- Removal of screwed wheel bearings with closed wheel hub on pick-ups and vans
- Only together with V3731 - V3732 - V2860 and hydraulic cylinder 16 t to 22 t
- Bolt circle 4- and 5-hole: 120 - 170 mm
- For models with closed wheel hub: DODGE Ram 1500 · FORD Transit



NEW



299.-€
excl. VAT



V5128, EAN 4047728051286

Standard wheel bearing and wheel hub installation and removal set

- Including multibox
- Effective method for disassembling wheel hubs. Recommendation: Use wheel bearing tool set V4598. The set also functions with steering knuckles with uneven and limited surfaces
- Significant time savings compared to earlier systems
- Together with hydraulic cylinder or manual spindle
- Allows the wheel bearings to be changed directly on the vehicle with minimum time spent
- Not necessary to remove the ABS sensor, steering knuckle, strut or steering tie rod
- Wheel alignment and brake bleeding not necessary
- All parts are adapted for the wheel bearing sizes currently found on the market
- Mounting washers have a guide and are usable on both sides
- Mounting washers with $\varnothing 62 - 83$ mm and support discs of $34 - 60$ mm are included, the bearing shell is suitable for wheel bearings of up to $\varnothing 92$ mm

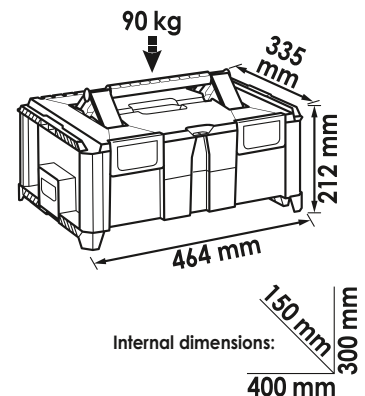
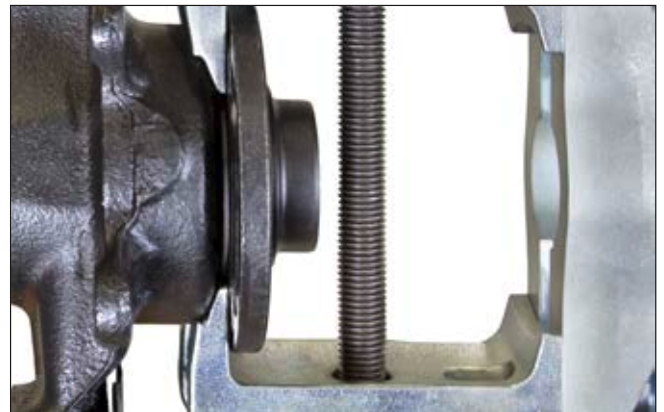
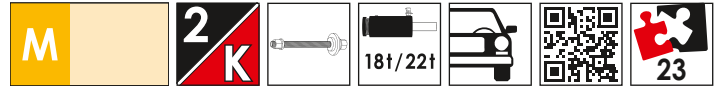

VIGOR No.	Designation	Design		EAN 4047728+	€
V4598	Wheel bearing, hub tool and drive shaft set · universal		16	045988	629.-
V4629	Wheel hub removal tool · universal		7	046299	518.50

1,137.- € excl. VAT

V5549, EAN 4047728055499

Multibox V4700-L · expansion set for compact wheel bearing/wheel hub

- In combination with the set V4680, all currently known wheel bearings can be assembled and disassembled
- Expansion set adding to V4680, for example
- Includes pressure feet for disassembling all common wheel hubs
- Additional pressure feet for screwed wheel bearing units (3 and 4 bolts) at the front and rear axle VAG · OPEL/VAUXHALL and many others
- Adjustability guarantees usage with all models of screwed wheel bearing units with 3 and 4 bolts currently available on the market
- e.g. for 4 bolts:
 - AUDI A4 · A6
 - VW Passat
 - ŠKODA Octavia
 - SEAT Exeo
- e.g. for 3 bolts:
 - VW Golf 6 convertible model years 2013 → · Golf model years → 2012 · Touran model years 2015 → · Tiguan model years 2016 → · Passat model years 2014 →
 - AUDI A3 model years 2012 → · TT model years 2014 → · Q2 model years 2016 →
 - ŠKODA Octavia model years 2012 → · Superb model years 2015 →
 - SEAT León model years 2012 →
 - OPEL/VAUXHALL Insignia, Astra model year 2004 →
 - CHEVROLET/GMC Malibu
 - SAAB 95 model years 2010 →
- Use with crossbar V3871

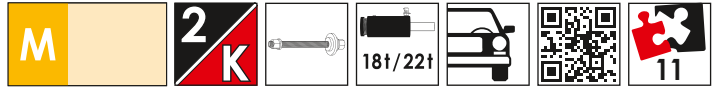

Two-piece standard wheel bearing



3 bolts screwed wheel bearing units



4 bolts screwed wheel bearing units

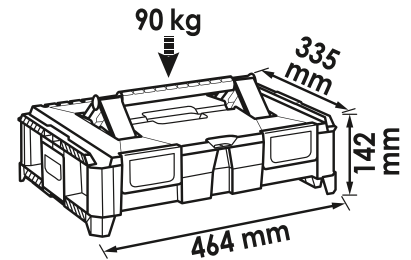

VIGOR No.	Designation	Design	mm	XX	EAN 4047728+	€
V3753	Pressure foot set (removal) for screwed wheel bearing units		-	2	037532	342.50
V3758	Pressure foot set (removal) for screwed wheel bearing units		-	2	037587	342.50
V4629-1	Pressure foot set for V4629		-	2	046305	342.50
V4598-30	Pressure pipe length 78 mm for V4598 · V4599		78	1	046282	58.86
V4614	Support disc · tapered · Ø 33.8 mm · for V4598		-	1	046145	20.37
V4598-2	Support disc · tapered · Ø 38.8 mm · for V4598		-	1	046152	23.82
V4598-3	Support disc · tapered · Ø 43.8 mm · for V4598 · V4599		-	1	046169	28.24
V4598-4	Support disc · tapered · Ø 59.8 mm · for V4598		-	1	046176	36.87

Internal dimensions:
80 mm
400 mm
300 mm

1,137.- € excl. VAT

V5741N, EAN 4047728**070485**

Longitudinal strut and wishbone bushing set · FORD · Volvo · MAZDA

- Including multibox
- Wishbone bushing set, for rear axle bushings
- Changing the bushing (front longitudinal strut in the rear area) and the rear axle bushing
- For e.g.:
 - FORD Focus · Focus Turnier, model years 1999 → · C-Max model years 2003 → · Kuga model years 2008 → · Galaxy model years 2006 → 2015 · Mondeo model years 2007 → 2015 · S-Max model years 2006 → 2014
 - Volvo V50 · S40 · C30, model year 2004 → · C70, model year 2006 → · S40, model year 2002 → 2012 · S60 · S80, model year 2010 → · V50, model year 2005 → 2012 · V60, model year 2010 → · V70, model year 2007 → 2015 · XC60, model year 2008 → · XC70, model year 2002 → 2007
 - MAZDA 3, model year 2003 → 2009 · 5, model year 2005 → 2010

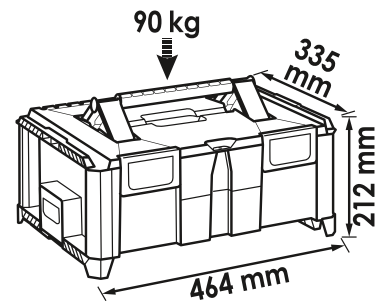

VIGOR No.	Designation	Design		EAN	€
V3056	Screw · M 16 x 40 mm		6	030564	11.64
V5902	Rear axle bushing set		6	059022	353.-
V3649	Bushing set longitudinal strut · FORD · Volvo		4	036498	342.50
V3053	Plate with thread		1	030533	205.50

Internal dimensions:
 150 mm
 300 mm
 400 mm

969.- €
 excl. VAT

V4680, EAN 4047728**046800**

Compact wheel bearing removal and installation set

- Including multibox
- Maximum loading capacity: 22 tonnes
- Use with hydraulic cylinder, mechanical spindle or workshop press
- E.g. on:
 - VW: Polo · Lupo · Touareg · Fox · T5 front and rear · Crafter
 - AUDI: A2
 - SEAT: Ibiza, Córdoba
 - ŠKODA: Fabia, Rapid, Roomster
 - FORD: Focus, C-Max, Mondeo, S-Max, Kuga
 - LANDROVER: Freelander 2
 - MAZDA: 3 · 5 · 6 · CX-7
 - MERCEDES-BENZ: Sprinter, Vito, Viano
 - MITSUBISHI: Colt
 - SMART: Forfour
 - Volvo: V50 · S40 · V70 · S80 · XC60
 - Other models
 - CITROËN: Jumpy (Dispatch), Space Tourer
 - PEUGEOT: Expert, Traveller
 - TOYOTA: ProAce (Verso)

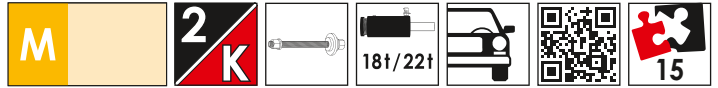

Assembly



Adjustability guarantees use of all types of current and future compact wheel bearings available on the market



Disassembly

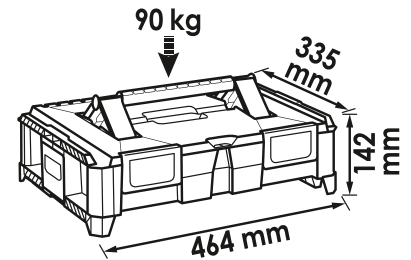

VIGOR No.	Designation	Design		EAN 4047728+	€
V2860	Compact wheel bearing removal set · universal		7	028608	505.50
V2864	Thrust washer · conical · universal		1	028646	44.20
V3680	Compact wheel bearing installation set · universal		13	036801	827.50

Internal dimensions:
 80 mm
 300 mm
 400 mm

1,131.- € excl. VAT



V5554, EAN 4047728055543

Compact wheel bearing removal and installation set and hydraulic foot pump

- Including multibox
- V4680 Universal tool set for removing and installing compact wheel bearings
 - Application on all compact wheel bearings currently available on the market
 - Simple adjustment mechanism allows the user to work with bearings of \varnothing 62 – 96 mm
- V2854 tractive and compressive hydraulic cylinder 22 tonnes
 - Pressure function – Using this briefly increases the impact when using the impact body. Application e.g. on corroded drive shafts or when working with the press frame
 - Automatic piston return function
- V2847 Hydraulic foot pump
 - For all VIGOR hydraulic cylinders
 - Driving pressure: 700 bar
 - Hose length: 2.2 m
 - Oil capacity: 0.75 l
 - Pump contains a CEJN quick coupler connection
 - Set in soft foam insert, with multibox L

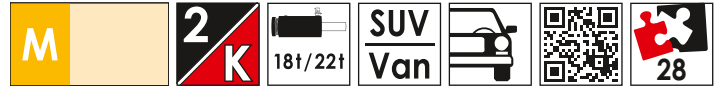

Universal set for removing and installing all compact wheel bearings

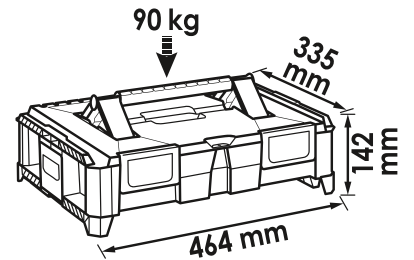

VIGOR No.	Designation	Design	mm	XX	EAN 4047728+	€
V4680	Compact wheel bearing removal and installation set		-	15	046800	1,131.-
V2854	Tractive and compressive hydraulic cylinder 22 tonnes		202	10	028547	883.-
V2847	Hydraulic foot pump		-	3	028479	581.-

Internal dimensions:
 80 mm
 300 mm
 400 mm

2,263.- €
excl. VAT

V5554-2, EAN 4047728069021

Compact wheel bearing removal and installation set and pneumatic foot pump

- Including multibox
- V4680 Universal tool set for removing and installing compact wheel bearings
 - Application on all compact wheel bearings currently available on the market
 - Simple adjustment mechanism allows the user to work with bearings of \varnothing 62 – 96 mm
- V2854 tractive and compressive hydraulic cylinder 22 t
 - Using the pressure function greatly increases the impact for a brief period of time when using the impact body
 - Application e.g. on corroded drive shafts or when working with the press frame
 - Automatic piston return function
- V2846 Hydraulic pump, pneumatic
 - For all hydraulic cylinders
 - Design including manometer



Universal set for removing and installing all compact wheel bearings

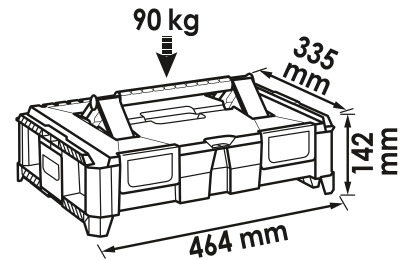

VIGOR No.	Designation	Design	mm	XX	EAN 4047728+	€
V4680	Compact wheel bearing removal and installation set		-	15	046800	1,131.-
V2854	Tractive and compressive hydraulic cylinder 22 tonnes		202	10	028547	883.-
V2846	Hydraulic pump · pneumatic		-	3	028462	807.50

Internal dimensions:
 80 mm
 300 mm
 400 mm

2,478.- € excl. VAT



V7133, EAN 4047728071338

Compact wheel bearing removal and installation set

- Including multibox
- Operating all compact wheel bearings from Smart to the Sprinter
- Used assembly unit V4491 ensures professional installation of the second generation compact wheel bearing
- Contents: Special unit for installing the closed wheel bearing and a universal set for all other compact wheel bearings diameters
- Cost and time savings by eliminating the need to install a new steering knuckle, the subsequent axle alignment and the associated additional work
- Including two V4700-L multiboxes

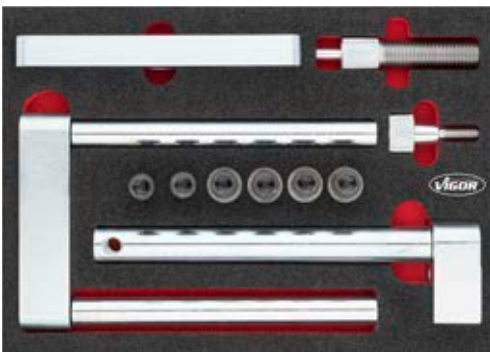

2 x

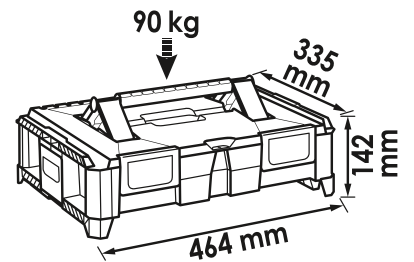

VIGOR No.	Designation	Design		EAN 4047728+	€
V7133N	Compact wheel bearing installation expansion set		14	071703	994.-
V4680	Compact wheel bearing removal and installation set		15	046800	1,131.-
V5027	Wheel hub puller		3	050272	226.50
V5905	Wheel hub / wheel bearing puller · for 6 and 8 bolts		-	059152	398.-

Internal dimensions:
 80 mm
 300 mm
 400 mm

2,209.- € excl. VAT

V7133N, EAN 4047728071703

Compact wheel bearing installation expansion set

- Operation of compact wheel bearings on Sprinter · Vito · Viano · Crafter
- Recommendation: use of a conventional tool set is not possible as a closed wheel bearing is fitted. Drive with a spindle system is not possible
- Special set for installing the wheel bearing closed at the wheel hub for the following vehicles, among others:
 - MERCEDES-BENZ V-Class model year 2014 → · Viano model year 2003 → · Vito box model year 2014 → · Sprinter model year 2008 →
 - VOLKSWAGEN Crafter model year 2011 →
- Cost and time savings by eliminating the need to install a new steering knuckle, the subsequent axle alignment and the associated additional work
- Prerequisite: Assembly unit for compact wheel bearing V4491 as well as drive unit, e.g. hydraulic cylinder V4551 or V2854
- Including multibox

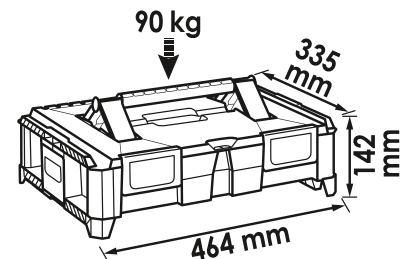
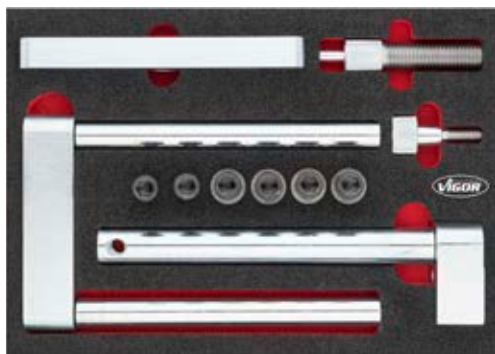

VIGOR No.	Designation	Design	mm	XX	EAN	€
V7133-2	Insert thread including guide M24 · L110 mm		110	1	071451	74.38
V7133-3	Insert crossbar CC = 160-186 mm · L 226 mm		-	1	071468	103.50
V7133-4	Insert fixation L 266 mm · M14 · M16		-	1	071475	96.80
V7133-5	Fixing screw M14 · tapered		-	1	071482	35.57
V7133-6	Insert hollow shanks L 242 mm · 2x M14		-	6	071499	113.50
V7133-7	Insert plate CC = 135-145 mm		-	1	071505	73.52
V7133-8	Fixation steering knuckle M14		-	1	071512	81.39
V7133-9	Screw sleeve 28x14.5 x 3 mm		-	1	071529	7.44
V7133-10	Screw sleeve M14x45 10.9		-	-	071536	9.27
V3056	Screw · M 16x40 mm		-	6	030564	11.64

Internal dimensions:
400 mm
80 mm
300 mm

994.- €
excl. VAT



V5169, EAN 4047728**051699**

Pressure sleeve set

- Including multibox
- Including 24 pressure pieces of different sizes
- Sleeves with small diameters are reversible
- Adapter and shaft enable the use of press frame V2885 – useful when removing or installing bushings and supporting joints without holes
- Larger sleeves for BMW E 38 / E 39 and MERCEDES-BENZ E-/S-Class, among others
- Set can be mounted on the wall due to the secure fit of the sleeves in foam
- Multibox V4700-L
- Outside dimensions: 464x335x142 mm
- Inside dimensions: 400x300x80 mm

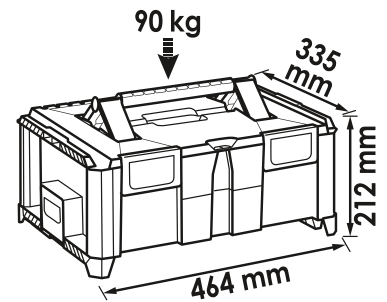

Internal dimensions:
 150 mm (height)
 300 mm (width)
 400 mm (length)

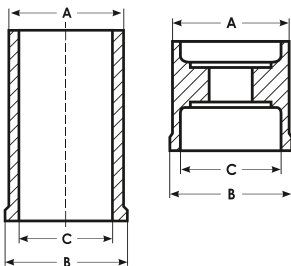

VIGOR No.	Designation	Design	∅ A mm	∅ B mm	∅ C mm	EAN 4047728+	€
V2947	Pressure sleeve		40.7	42.5	35.2	029476	38.16
V2948	Pressure sleeve		43.7	45.5	38.2	029483	38.16
V2949	Pressure sleeve		46.7	48.5	41.2	029490	38.16
V2950	Pressure sleeve		49.7	51.5	44.2	029506	43.12
V2961	Pressure sleeve		52.7	54.5	47.2	029612	43.12
V2962	Pressure sleeve		55.7	57.5	50.2	029629	43.12

721.- €
excl. VAT



VIGOR No.	Designation	Design	Ø A mm	Ø B mm	Ø C mm	EAN 4047728+	€
V2963	Pressure sleeve		58.7	60.5	53.2	029636	43.12
V2964	Pressure sleeve		61.7	63.5	56.2	029643	50.88
V2965	Pressure sleeve		65.7	67.5	60.2	029650	50.88
V2966	Pressure sleeve		69.7	71.5	64.2	029667	57.03
V2967	Pressure pipe		38.7	44.7	30.5	029674	38.16
V2968	Pressure pipe		41.7	44.7	34.0	029681	38.16
V2969	Pressure pipe		44.7	44.7	37.2	029698	40.96
V2971	Pressure pipe		47.7	55.0	40.2	029711	40.43
V2972	Pressure pipe		50.7	55.0	43.2	029728	41.83
V2973	Pressure pipe		53.7	55.0	46.2	029735	39.24
V2974	Pressure pipe		56.7	55.0	49.2	029742	41.72
V2975	Pressure pipe		59.7	70.0	52.2	029759	50.77
V2976	Pressure pipe		62.7	70.0	55.2	029766	50.77
V2977	Pressure pipe		65.7	70.0	58.2	029773	50.77
V2978	Pressure pipe		68.8	70.0	61.2	029780	50.77
V2979	Pressure pipe		71.7	70.0	64.2	029797	50.77
V2980	Pressure pipe		75.7	75.7	68.2	029803	62.74
V2981	Pressure pipe		79.7	79.7	72.2	029810	66.51
V2946	Thrust rod · adjustable · 90 mm for V2868		-	-	-	029469	64.57
V2945	Adapter plate for V2868		-	-	-	029452	45.17

V5169-A, EAN 4047728075381

Pressure sleeve expansion set

- Removal and installation of bearings, bushings and ball joints
- For extending the pressure sleeve set V5169



VIGOR No.	Designation	Design	EAN 4047728+	€
V5169-A45	Adapter pressure sleeves · 45 mm		075398	50.-
V5169-A55	Adapter pressure sleeves · 55 mm		075404	50.-
V5169-A70	Adapter pressure sleeves · 70 mm		075411	50.-
V5169-A76	Adapter pressure sleeves · 76 mm		075428	50.-
V5169-A80	Adapter pressure sleeves · 80 mm		075435	50.-

249.- €
excl. VAT

V5168, EAN 4047728051682

Set of devices for the removal of drive shafts

- Including multibox
- For removing rusted and stuck drive shafts directly on the vehicle
- Working time approx. 5 minutes only
- For all passenger cars with 4- and 5-hole wheel hubs due to oval holes for wheel bolts
- Prevents heating of or damage to the drive shaft or damage to other parts
- Application: screwing the wheel hub on with the vehicle wheel nuts, removing the drive shaft with a 18 tonne or 22 tonne hydraulic cylinder (the installation of the impact body enables additional force by using a hammer), removal of the wheel hub with sliding hammer V2922 and adapter V2872

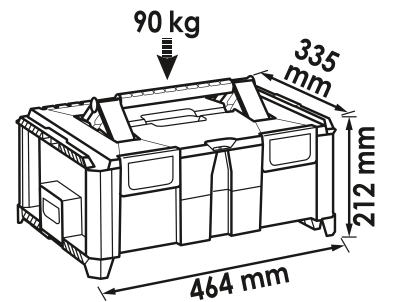
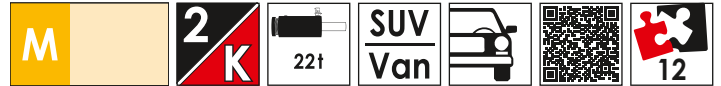

Internal dimensions:
150 mm
300 mm
400 mm

VIGOR No.	Designation	Design	mm	XX	EAN 4047728+	€
V2849	Device for the removal of drive shafts · 4 and 5 holes		-	2	028493	538.-
V2854	Tractive and compressive hydraulic cylinder 22 tonnes		202	10	028547	883.-

1,248.- €
excl. VAT

V7154-4, EAN 4047728071765

Brake disc removal set

- Including multibox
- Separates severely rusted brake discs and those that are stuck to the wheel hubs
- Strong hammering on the brake discs can damage the wheel bearing
- Transmission of even pressure across the removal tool feet onto the brake disc. The hydraulic cylinder is supported by an adapter piece on the drive shaft screw connection
- Significantly minimises the risk of damage with an even transmission of force to the brake disc from the four feet
- Recommendation: use of a hydraulic cylinder, e.g. V4551 or V2854
- Alternative application with V4699
- Span width: 260 – 330 mm
- Maximum loading capacity: 22 t

SUV Van	18t/22t	21
------------	---------	----

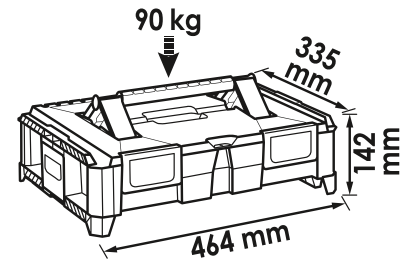

VIGOR No.	Designation	Design		EAN 4047728+	€
V3871	Cross beam for various pressure feet		1	038713	234.-
V5904-4	Screw · M 14 × 45 · inside hexagon		2	059145	11.32
V7154-1	Removal foot · individual		-	071550	66.62
V7154-2	Fixing plate · individual		-	071567	169.50
V5904-3	Sliding plate		4	059138	12.50

Internal dimensions:
80 mm
300 mm
400 mm

938.- €
excl. VAT

-
-
-
-
-
-
-
-
-
-
-
-

V3740, EAN 4047728**037402**

Installation tool set for BMW drive shafts (mechanical)

- Manual installation of the drive shaft using the M 22 drawbar and nut
- Adapter made of high-strength steel for drive shafts with M 24 x 1.5 and M 27 x 1.5 threads included
- Installation of the drive shafts in e.g.
 - BMW 5 Series, M 5: 5 GT F07 (model years 2009 → 2015)
 - 5 F10/F11/F18 (model years 2009 → 2015)
 - 5 E60/61 SED/TOU (model years 2002 → 2010)
 - 5 E39 (model years 1995 → 2004)
 - BMW 3 Series, M 3: 3 F30/31 (model years 2012 → 2015)
 - 3 E90/E93 COUPÉ/CAP (model years 2005 → 2015)
 - 3 E92/E93 SED/TOU (model years 2005 → 2012)
 - 3 E46 (model years 1998 → 2005)
 - BMW 7 Series: 7 F01/F02/F03/F04 (model year 2009 → 2015)
 - 7 E65/E66 (model year 2000 → 2008)
 - 7 E38 (model year 1993 → 2001)
 - BMW X5 Series: X5 E70 (model year 2007 → 2015)
 - X5 E53 (model year 1999 → 2001)
 - BMW 1 Series: 1 F20/F21 (model year 2011 → 2015)
 - 1 E82/E88 COUPÉ/CAB (model year 2006 → 2015)
 - 1 E87/E81 5D/3D (model year 2003 → 2011)
 - BMW X3 Series: X3 F25 (model year 2010 → 2015)
 - X3 E83 (model year 2003 → 2010)
 - BMW 6 Series, M 6: 6 F12/F13 (model year 2010 → 2015)
 - 6 E63/64 (model year 2002 → 2010)
 - BMW Z4 Series: Z4 E89 (model year 2009 → 2015)
 - Z4 E85/86 COUPÉ/CAB (model year 2002 → 2008)
 - BMW X6: X6 E71/E72
 - BMW X1: X1 E84 (model year 2010 → 2015)



313.50 €
excl. VAT

VIGOR No.	Designation	Design	mm		EAN 4047728+	€
V2969	Pressure pipe		-	1	029698	40.96
V3708	Adapter · M 27 x 1.5 mm		-	1	037082	95.19
V3709	Adapter · M 24 x 1.5 mm		-	1	037099	95.19
V3132	Flange nut · M 22 x 2.5		-	1	031325	57.03
V3868	Thrust washer · inside Ø 23 mm · suitable for M 20 spindle		-	1	038683	41.83
V3133	Drawbar · M 22 · maximum 32 t		250	1	031332	62.09

V3751, EAN 4047728037518

Installation tool set for BMW drive shafts (hydraulic)

- Drive shaft installation
- Hydraulic cylinder pulls the drive shaft into the correct position without any problems
- For e.g.:
 - BMW 5 Series, M 5:
 - 5 GT F07 (model year 2009 → 2015)
 - 5 F10/F11/F18 (model year 2009 → 2015)
 - 5 E60/61 SED/TOU (model year 2002 → 2010)
 - 5 E39 (model year 1995 → 2004)
 - BMW 3 Series, M 3:
 - 3 F30/31 (model year 2012 → 2015)
 - 3 E90/E93 COUPÉ/CAP (model year 2005 → 2015)
 - 3 E92/E93 SED/TOU (model year 2005 → 2012)
 - 3 E46 (model year 1998 → 2005)
 - BMW 7 Series:
 - 7 F01/F02/F03/F04 (model year 2009 → 2015)
 - 7 E65/E66 (model year 2000 → 2008)
 - 7 E38 (model year 1993 → 2001)
 - BMW X5 Series:
 - X5 E70 (model year 2007 → 2015)
 - X5 E53 (model year 1999 → 2001)
 - BMW 1 Series:
 - 1 F20/F21 (model year 2011 → 2015)
 - 1 E82/E88 COUPÉ/CAB (model year 2006 → 2015)
 - 1 E87/E81 5D/3D (model year 2003 → 2011)
 - BMW X3 Series:
 - X3 F25 (model year 2010 → 2015)
 - X3 E83 (model year 2003 → 2010)
 - BMW 6 Series, M 6:
 - 6 F12/F13 (model year 2010 → 2015)
 - 6 E63/64 (model year 2002 → 2010)
 - BMW Z4 Series:
 - Z4 E89 (model year 2009 → 2015)
 - Z4 E85/86 COUPÉ/CAB (model year 2002 → 2008)
 - BMW X6:
 - X6 E71/E72
 - BMW X1:
 - X1 E84 (model year 2010 → 2015)

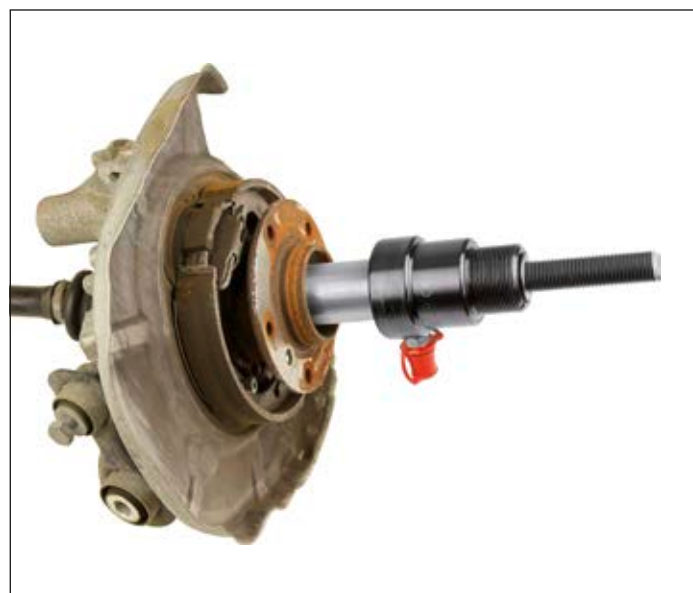

740.- €
excl. VAT

VIGOR No.	Designation	Design	mm	XX	EAN 4047728+	€
V2873	Tractive and compressive hydraulic cylinder 8.5 tonnes		106	4	028738	508.50 *
V2969	Pressure pipe		-	1	029698	40.96
V3708	Adapter · M 27x1.5 mm		-	1	037082	95.19
V3709	Adapter · M 24x1.5 mm		-	1	037099	95.19
V3133	Drawbar · M 22 · maximum 32 t		250	1	031332	62.09

* Price per set

V2849, EAN 4047728028493

Device for the removal of drive shafts · 4 and 5 holes

- For removing rusted and glued drive shafts directly on the vehicle
- For passenger cars with T4 and 5-hole wheel hubs due to oval holes for wheel bolts
- Prevents heating of or damage to the drive shaft or damage to other parts
- Application:
 - Screw the wheel hub on with the vehicle wheel nuts
 - Remove the drive shaft with a 18 tonne or 22 tonne hydraulic cylinder. (The installation of the impact body enables additional force by using a hammer)
 - Removal of the wheel hub with sliding hammer V2922 and adapter V2872



Working time:
approx. 5 minutes only



VIGOR No.	Designation	Design	EAN 4047728+	€
V3147	Axle drive shaft 4 holes · bolt circle 92 – 120 mm		031479	348.–
V3148	Axle drive shaft 5 holes · bolt circle 98 – 131 mm		031486	348.–

538.– €
excl. VAT



V2922, EAN 4047728029223

Sliding hammer 5.2 kg

- Removing wheel hub and brake disc
- Used with wheel hub tool set V2871 or adapter V2872 for drive shaft tool V2849
- Sliding hammer, ergonomically shaped



Inside thread: M 18

330.50 €
excl. VAT



V2872, EAN 4047728028721

Adapter for sliding hammer V2922

- Adapter to be used with sliding hammer (V2922) and drive shaft tool (V2849) for wheel hub removal



Outside thread: M 18

Outside thread: 1.1/2"



68.67 €
excl. VAT

V2871, EAN 4047728028714

Wheel hubs removal set for V2922

- Removing wheel hubs with sliding hammer V2922



6

VIGOR No.	Designation	Design	mm	EAN 4047728+	€
V3140	Drawbar M 18		150	031400	66.62
V3126	Flange nut · M 18x2.5		-	031264	41.83
V3036	Support disc Ø 52 mm · inside hole Ø 20.25 mm · suitable for spindle M 20		-	030366	24.04
V3035	Support disc Ø 45 mm · inside hole Ø 20.25 mm · suitable for spindle M 20		-	030359	19.08
V3034	Support disc Ø 40 mm · inside hole Ø 20.25 mm · suitable for spindle M 20		-	030342	16.60
V3033	Support disc Ø 32 mm · inside hole Ø 20.25 mm · suitable for spindle M 20		-	030335	15.20



215.50 €
excl. VAT



V5916, EAN 4047728**059817**

Ball joint ejector · hydraulic 4.5 tonnes

- For the hydraulic removal of the ball joint pivots on tie rods as well as stabilisers with a maximum compressive force of 4.5 tonnes
- Height adjustment 60 and 72 mm as well as adjustable diameter to 26 and 32 mm
- The design optimises access to hard-to-reach areas
- Tool can, with the help of the spacer ring provided, be set at various stroke lengths
- Pressure feet installed on both sides to enable work in areas with restricted access
- The safety strap provided prevents the tool from falling down after use
- Operation with hydraulic pump V2846 and V2847 (700 bar)
- Specially installed for modern aluminium steering knuckles with conically tapered screws



4.5 t

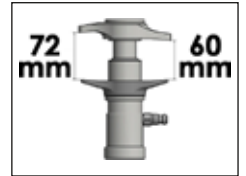

807.50 €
excl. VAT

V5916-1, EAN 4047728072953

Ball joint ejector extension pins

- Pressing out ball joints as well as steering tie rod ends, with bolts instead of nut threaded connections on the cone axis
- Pressure plate extension for ball joint ejector V5916
- Upper plate can be adapted and adjusted individually to the installation situation



171.50 €
excl. VAT



V5916-2, EAN 4047728073554

Pressure foot extension

- For ball joint pins with a length over 72 mm
- Used in e.g. SUVs and commercial vehicles from CHEVROLET or GMC
- Set consisting of pressing tool and pressing piece
- Operated with hydraulic ball joint ejector V5916
- Can be used in constricted spaces



117.50 €
excl. VAT



V5916-XL, EAN 4047728066471

Ball joint ejector · hydraulic 8.8 tonnes

- For the hydraulic removal of the ball joint pivots on tie rods as well as stabilisers, or steering and brake lever for trucks and buses, with a maximum compressive force of 8.8 tonnes
- Height adjustment 81 and 113 mm as well as adjustable diameter to 42 and 56 mm
- The design optimises access to hard-to-reach areas
- The tool can, with the help of the spacer rings provided, be set at various stroke lengths
- Pressure feet installed on both sides to enable work in areas with restricted access
- The safety strap provided prevents the tool from falling down after use
- Operation with hydraulic pump V2846 · V2847 (700 bar)
- Specially for modern aluminium steering knuckles with conically tapered screws installed
- ⚖ 7.0 kg

8.8 t

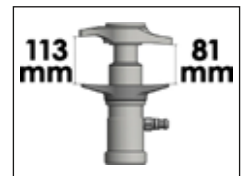

1,159.- €
excl. VAT



V2885, EAN 4047728028851

Press frame with open plate with adapter to close the plate

- Changing supporting joints and rear axle bushings
- Open press frame plate is closed by the adapter ring
- Inside diameter of both struts at 118 mm



VIGOR No.	Designation	Design	XX	EAN 4047728+	€
V3053	Plate with thread		1	030533	205.50
V3055	Support		2	030557	70.72
V3142	Adapter plate		1	031424	47.54
V3056	Screw - M 16x40 mm		6	030564	11.64
V3057	Open plate		-	030571	151.50

342.50 €
excl. VAT

Table of pressure pieces for different passenger cars

Type	Thrust block
BMW E30, E36 (inside)	V2906, V2905, V2904
BMW E36 (outside)	V2909, V2908, V2907
MERCEDES-BENZ type 124	V2906, V2905, V2902
MERCEDES-BENZ Sprinter	V2901, V2900
MERCEDES-BENZ Sprinter 2007 →	V2895, V2894, V2893
DACIA Logan I (model years 2006 → 2013), RENAULT Clio 3 (model years 2006 → 2013), RENAULT Grand Scénic I (model years 2003 → 2009), RENAULT Laguna 1, RENAULT Mégane 2, RENAULT Modus (model years 2005 → 2013), RENAULT Scénic 2	V2906, V2892, V2891
NISSAN Interstar, OPEL/VAUXHALL Movano, RENAULT Master	top: V2899, V2897
	bottom: V2903, V2899, V2898
VW T4	V2901, V2899
VW LT35	V2901, V2900
VW Crafter	V2895, V2894, V2893
HYUNDAI Trajet, Santa Fé	V2898, V2896, V2892

Table of pressure pieces and price

VIGOR No.	EAN 4047728+	€
V2891	028912	127.-
V2892	028929	127.-
V2893	028936	88.40
V2894	028943	151.50
V2895	028950	113.-
V2896	028967	109.50
V2897	028974	120.50
V2898	028981	109.50
V2899	028998	101.50
V2900	029001	101.50
V2901	029018	82.90
V2902	029025	127.-
V2903	029032	88.40
V2904	029049	113.-
V2905	029056	69.64
V2906	029063	69.64
V2907	029070	69.64
V2908	029087	65.22
V2909	029094	226.50



Bearing and bushing tool sets



V3649, EAN 4047728036498

Bushing set longitudinal strut · FORD · Volvo

- Changing the bushing of the front longitudinal strut in the rear area
- Do not load the bushing and press frame with more than 16 tonnes
- For e.g.:
 - FORD: Mondeo · Tourneo model year 2000 → 2007
 - FORD: model year 2007 →: Mondeo, S-Max, Galaxy
 - Volvo: model year 2007 →: S60 · S80 · V60 · V70 · XC60 · XC70



**Working time:
15 minutes per
change**



VIGOR No.	Designation	Design	EAN 4047728+	€
V3650	Press frame		036504	319.50
V3403	Pressure pipe		034036	214.–
V3405	Adapter ring		034050	125.50
V3404	Pressure plate		034043	125.50

**Use only in
conjunction with
V3053 and V3056**

342.50 €
excl. VAT

V3053, EAN 4047728030533

Plate with thread



205.50 €
excl. VAT

V3056, EAN 4047728030564

Screw · M 16 x 40 mm

- Screw · M 16 x 40 mm



Price per piece

11.64 €
excl. VAT

V2913, EAN 4047728029131

Supporting joint tool set MERCEDES-BENZ

- Changing supporting joint
- MERCEDES-BENZ E-Class, model 211 · 219 · S-Class model 220 · SL-Class model 230
- With supporting joint dismounting bushing V2915, also suitable for MERCEDES-BENZ ML 163
- Only to be used together with press frame (V2858N)



VIGOR No.	Designation	Design	← L → mm	EAN 4047728+	€
V3047	Pressure sleeve		-	030472	69.64
V3048	Mounting bushing		-	030489	65.87
V3049	Dismounting ring		-	030496	74.06
V3129	Thrust block · adjustable M 24		132	031295	75.89



204.50 €
excl. VAT

V2915, EAN 4047728029155

Supporting joint dismounting bushing, MERCEDES-BENZ

- For MERCEDES-BENZ ML 163
- Application together with V2913
- Only to be used together with press frame (V2858N)



83.98 €
excl. VAT

V2923, EAN 4047728029230

Supporting joint tool set FORD

- For FORD Transit
- Working directly on the vehicle
- Working time: 10 minutes
- Only to be used together with press frame (V2858N)



VIGOR No.	Designation	Design	EAN 4047728+	€
V2999	Pressure sleeve		029995	143.50
V3000	Mounting / dismounting cap		030007	105.-
V3001	Mounting bushing		030014	134.-
V3002	Dismounting bushing		030021	105.-



431.- €
excl. VAT

V2914, EAN 4047728029148

Stabilizer ball joint tool set MERCEDES-BENZ

- For MERCEDES-BENZ: E-Class, model 211 and S-Class model 220
- Only remove the stabiliser – Removing the shock absorbers or the control arm mounting is not necessary
- Only to be used together with press frame (V2858N)



VIGOR No.	Designation	Design	EAN 4047728+	€
V3045	Pressure sleeve		030458	69.64
V3046	Pressure sleeve		030465	69.64



122.50 €
excl. VAT

Bearing and bushing tool sets



V2886, EAN 4047728028868

Rear axle bushing tool set VW · AUDI · SEAT · ŠKODA

- Changing rear axle bushings
- For e.g.:
 - AUDI A3 (8L), model year 1997 → 2003 · TT (8N), model year 1999 → 2006
 - VW Beetle (1), model year 1998 → 2010 · Bora, model year 1998 → 2005 · Golf 4 model year 1997 → 2008 · Polo (4), model year 2002 → 2012
 - SEAT Ibiza (3), model year 2002 → 2009 · León (1), model year 1999 → 2006 · Toledo (2), model year 1999 → 2005
 - ŠKODA: Fabia (1), model year 2000 → 2008 · Octavia (1), 1998 → 2010 · Roomster, model year 2006 → · Rapid, model year 2012 →
- Only together with V2885



Working time: approx. 20 minutes

VIGOR No.	Designation	Design	EAN 4047728+	€
V3214	Mounting bushing		032148	123.–
V3212	Dismounting ring		032124	196.50
V3213	Dismounting bushing		032131	106.50
V3215	Assembly ring		032155	77.94



458.50 €
excl. VAT

V5902, EAN 4047728059022

Rear axle bushing set

- For rear axle bushing e.g. on:
 - FORD Focus, model year 1999 → · Focus, model year 2018 → · C-Max, model year 2003 → · Kuga, model year 2008 →
 - MAZDA 3 model year 2003 → · 5 model year. 2005 → 2011
 - Volvo V50 · S40 · C30 model year 2004 → · C70 model year 2006 →
- Only in conjunction with V2885



VIGOR No.	Designation	Design	EAN 4047728+	€
V3100	Dismounting/mounting bushing		031004	119.–
V3102	Retaining ring		031028	114.50
V3101	Mounting washer		031011	101.–
V3103	Thrust washer		031035	51.21
V5902-1	Mounting bushing		059015	80.85
V5902-2	Retaining ring		059039	85.16

353.– €
excl. VAT

V2916, EAN 4047728029162

Silent block bushing set · rear · BMW

- Changing the rear silent block bushings
- For e.g. BMW E53 (X) · E60–65 (5 · 6 · 7 Series), E81 · E82 · E82E, E87 · E87N · E88 (1 Series), E 90 (1 · 3 Series) · E90N · E91 · E91N · E92N · E93 · E93N (3 Series)
- Working time: approx. 45 minutes for all four bushings



VIGOR No.	Designation	Design	mm	EAN 4047728+	€
V3021	Pressure sleeve		-	030212	132.50
V3026	Pressure pipe		-	030267	67.48
V3024	Retaining washer E32 and E34		-	030243	79.88
V3020	Mounting washer		-	030205	116.-
V3025	Mounting washer		-	030250	89.58
V2996	Counterholder ring		-	029964	151.50
V2997	Washer with thread		-	029971	163.50
V3028	Washer with thread		-	030281	164.50
V3031	Washer with thread		-	030311	164.50
V3023	Thrust washer		-	030236	63.60
V3019	Retaining ring		-	030199	143.50
V2995	Assembly ring		-	029957	82.90
V3136	Drawbar · M 14 · maximum 12 t		250	031363	49.59
V3127	Drawbar · M 18 M 22 · maximum 22 t		250	031271	69.75
V3139	Drawbar M 18 / M 22		180	031394	68.45
V3135	Adapter · M 22x2.5 – M 14x2.0		-	031356	37.95
V3027	Thrust washer		-	030274	98.42
V3030	Mounting ring		-	030304	76.32
V2998	Thrust washer		-	029988	163.50
V3022	Retaining ring E32/E34		-	030229	118.50
V3029	Retaining ring		-	030298	143.50

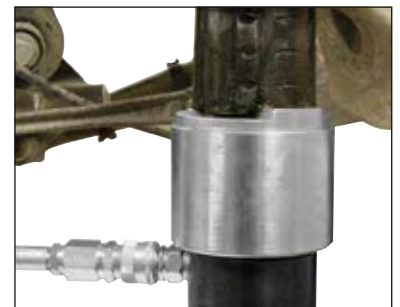

1,924.- €
excl. VAT

Bearing and bushing tool sets



V3256, EAN 4047728032568

Silent block bushing set · rear · BMW X5 · E53

- Changing the rear silent block bushings
- On BMW X5 (E53) rear
- Working time: approx. 45 minutes for all four bushings



VIGOR No.	Designation	Design	mm	EAN 4047728+	€
V3026	Pressure pipe		-	030267	67.48
V3021	Pressure sleeve		-	030212	132.50
V3023	Thrust washer		-	030236	63.60
V3127	Drawbar · M 18 M 22 · maximum 22 t		250	031271	69.75
V3027	Thrust washer		-	030274	98.42
V3019	Retaining ring		-	030199	143.50
V3020	Mounting washer		-	030205	116.-
V3302	Washer with thread · inside Ø 23 mm · suitable for M 22 spindle		-	033022	130.-

727.-€
excl. VAT

V2857, EAN 4047728028578

Tool set for silent blocks VW · AUDI · SEAT · ŠKODA

- Changing the silent block
- VW: Polo 9N model year 2002 → 2009 · Fox model year 2005 → · Caddy 3 · Eos model year 2006 → · Golf 5 model year 2003 → · Tiguan model year 2007 →
- AUDI: A2 model year 2000 → 2005 · A3 model year 2003 →
- SEAT: Ibiza · Altea · Córdoba model year 2003 → 2005 · Córdoba · Ibiza model year 2002 → · Altea model year 2004 → · León model year 2005 →
- ŠKODA: Fabia model year 2000 → 2004 · Roomster model year 2006 → · Octavia 2004 →
- Changing the rear bushing of the triangular control arm
- For manual use



VIGOR No.	Designation	Design	mm	XX	EAN 4047728+	€
V3016	Mounting washer		-	1	030168	68.56
V3015	Pressure pipe		-	1	030151	87.32
V3137	Flange nut · M 14x2.0		-	2	031370	37.95*
V3138	Drawbar M 14		150	1	031387	43.87
V3014	Dismounting/mounting washer		-	1	030144	132.50
V3017	Dismounting washer		-	1	030175	68.56

242.-€
excl. VAT

* Price per piece



V3436, EAN 4047728034364

Tool set for double silent blocks VAG

- For:
 - VW: Caddy 3 (2004→2010), Eos (2006→), Golf 5 (2003→2009), Golf 6 (2008→), Golf 7 (2012→), Scirocco (2005→), Jetta 3 (2005→2010), Passat (2005→2010), Tiguan (2007→), Touran (2003→)
 - SEAT: Altea (2004→), León (2005→), Toledo (2004→2009)
 - ŠKODA: Octavia (2004→2010)
 - AUDI: A3 (2005→), TT (2006→2010)
- Note: Due to limited space on the vehicle, we recommend replacing the silent block using a workshop press
- Extraction / insertion with only a few parts



VIGOR No.	Designation	Design	EAN 4047728+	€
V3423	Mounting pipe		034234	114.-
V3425	Pressure pipe		034258	109.50
V3424	Thrust washer		034241	125.50

276.50 €
excl. VAT

V3631, EAN 4047728036313

Transverse control arm bushing set · front · VW T5

- Changing the rear wishbone bushing on the front wishbone
- VW T5, model year 2004→
- Working time: approx. 15 minutes only



VIGOR No.	Designation	Design	mm		EAN 4047728+	€
V3136	Drawbar · M 14 · maximum 12 t		250	1	031363	49.59
V3641	Thrust plate · inside Ø 23 mm · suitable for M 22 spindle		-	1	036412	87.43
V3642	Pressure sleeve		-	1	036429	100.-
V3137	Flange nut · M 14x2.0		-	2	031370	37.95
V3135	Adapter · M 22x2.5 - M 14x2.0		-	1	031356	37.95

255.- €
excl. VAT

Bearing and bushing tool sets



V2917, EAN 4047728029179

Control arm bushing set · rear · MERCEDES-BENZ

- Changing the rear/bottom bushings of the longitudinal control arm
- For MERCEDES-BENZ: C-, E-, S-Class

18t/22t

7



VIGOR No.	Designation	Design	l mm	XX	EAN 4047728+	€
V3052	Pressure pipe		-	1	030526	94.86
V3136	Drawbar · M 14 · maximum 12 t		250	1	031363	49.59
V3135	Adapter · M 22x2.5 – M 14x2.0		-	1	031356	37.95
V3050	Dismounting ring		-	1	030502	72.23
V3051	Mounting bushing		-	1	030519	74.06
V3044	Retaining ring, installation		-	1	030441	81.82
V3137	Flange nut · M 14x2.0		-	2	031370	37.95

226.50 €
excl. VAT

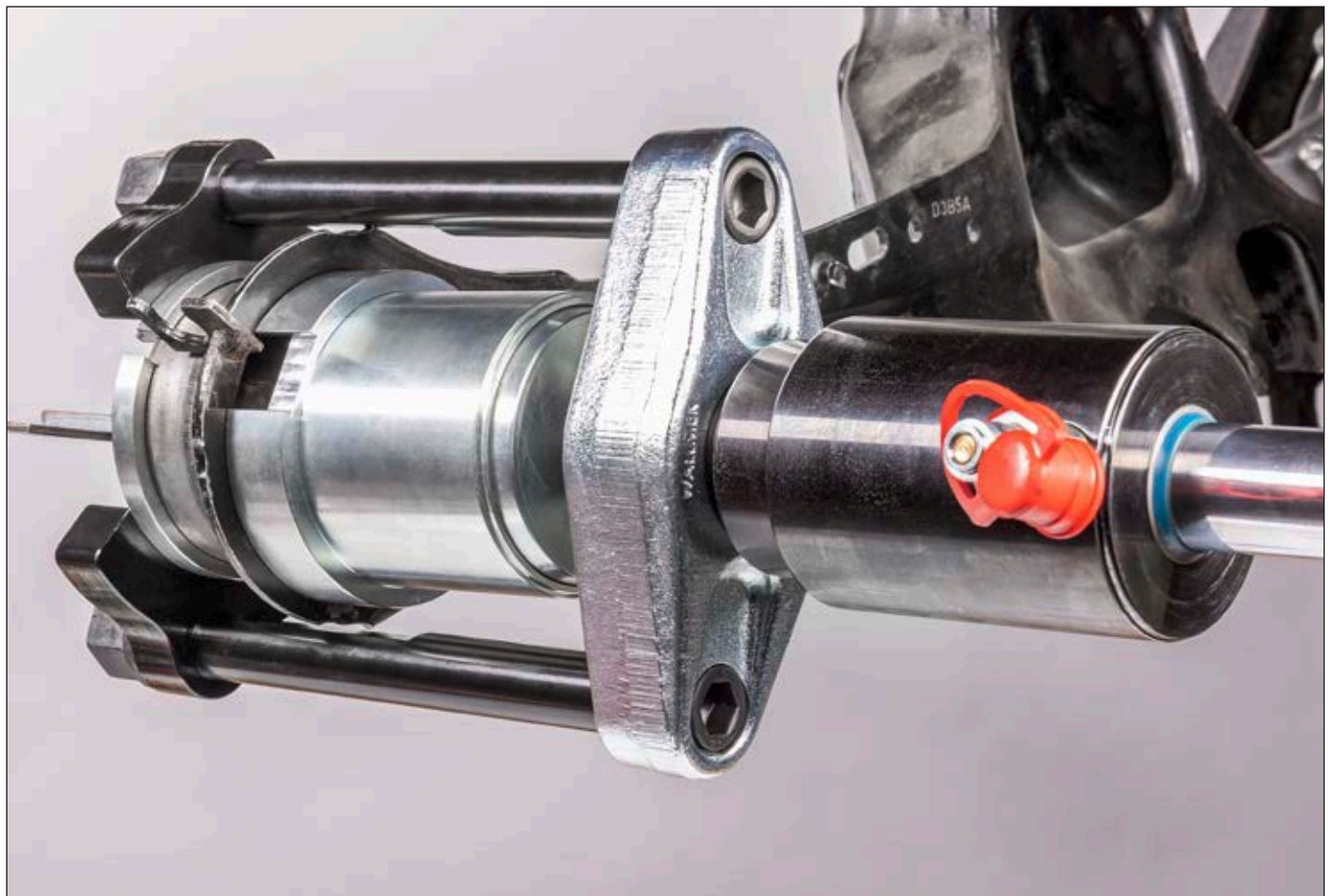

V4476N, EAN 4047728068000

Hydraulic safety spring vice including 10 spring plates

- Can be used for almost any spring strut and shock absorber in the field of passenger cars as well as lightweight vans
- Also for MERCEDES-BENZ C-Class (W203), newer BMW and VAG spring struts, with electronic shock absorbers (EDC, DCC)
- By gripping the springs within the spring windings any possible awkward parts on the shock absorber are irrelevant and have no influence on the operation of the safety spring vice
- Can be used both for left and right-hand wound springs
- Precise alignment of spring and shock absorber struts
- Also for separating steering knuckles and spring struts by relieving strain on the spring strut directly on the vehicle without removing the axle shaft, axle alignment possibly no longer required
- Tripod with included rollers enables stowing and mobile work with the safety spring vice – no work bench space needed
- Reverse placement of the supporting frame allows the safety spring vice to be used as an additional hydraulic support and can be used with 2.1 tonnes of force, e.g. for work on control arms or supporting joints
- "Quick pin" mechanism allows quick and easy repositioning of the safety spring vice in order to use the three functions: gripping the spring, separating the steering knuckles from the spring struts and as a hydraulic support
- Sturdy tripod foot with locking element and positioning mechanism for a stable and balanced footing
- When tensioning old springs which are more likely to break, the robust safety belt serves as an additional safety feature
- Including all spring plates (4x V4352, 4x V4353 · 2x V4354)
- Hydraulic pump with a working pressure of 700 bar is required for operation (V2846 / V2847)
- Weight: 44 kg
- Capacity: 2.1 tonnes
- Stroke: 430 mm
- Spring plate Ø 70 – 160 mm



1. Change/tension springs

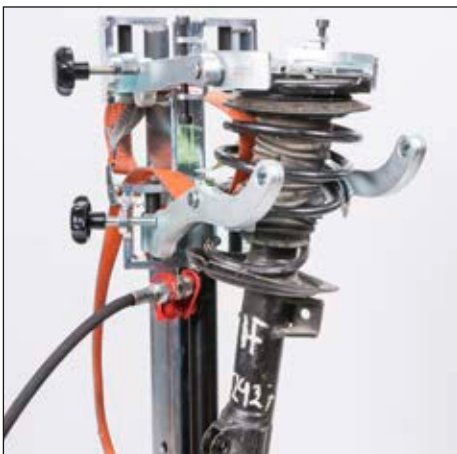

2. Pre-tension springs directly on the vehicle



3. Aluminium universal support



Safety spring vice



Safety belt



Quick release lock / Quick pin



2.1 tonnes cylinder



Adjust height by turning gripping jaws



Height adjustment of the arms

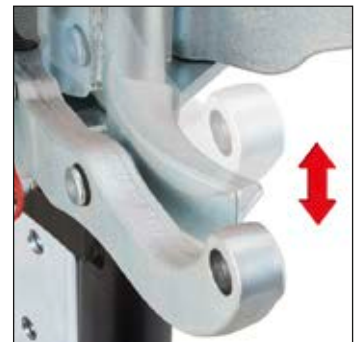

Mobile safety spring vice thanks to castors

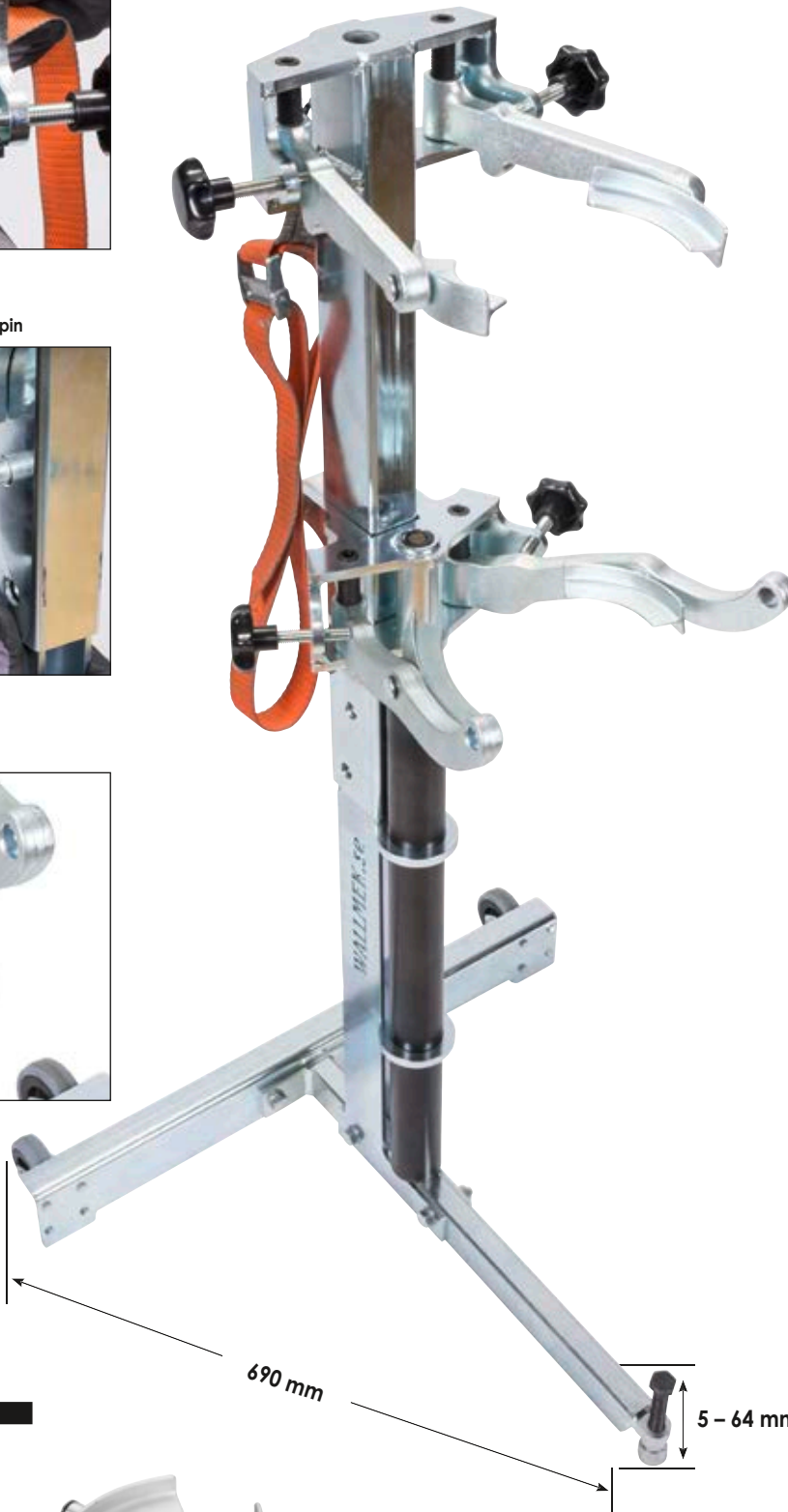

690 mm

5 - 64 mm

2,155.- €
excl. VAT





V4476-1, EAN 4047728060264

**Adapter ring for OPEL/
VAUXHALL Insignia**



- For use with VIGOR safety spring vice V4476
- Additional adapter ring is necessary for work on spring struts of the following vehicles:
- OPEL/VAUXHALL Insignia B model years 2017 → 2019
 - Saloon Grand Sport
 - Sports Tourer station wagon



82.90 €
excl. VAT



V4354, EAN 4047728043540

**Spring plate Ø 150 – 240 mm
with locking element**

- Individual spring plates (four spring plates are required)
- Can only be used with safety spring vice V4307
- Especially for CHRYSLER Voyager



Price per piece

138.- €
excl. VAT



V5160, EAN 4047728051606

VIGOR
SERIES **XL**

Mobile work bench with specialty tool assortment

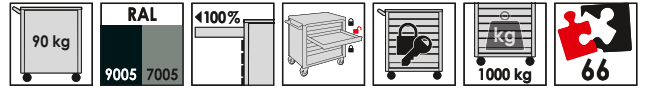

Variants fitted with drawers

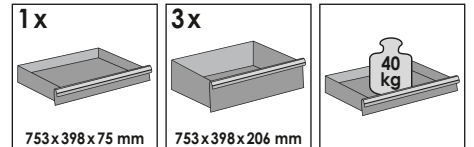

Delivery without pull-handle

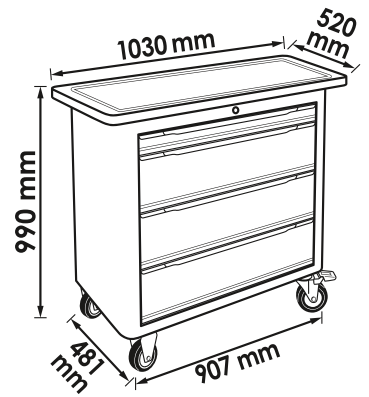

+ assortment

5,691.- €
excl. VAT

V7201



V4906



V4921



V4908



V4915



V5062



V5058



Mobile work benches with specialty tool assortment



V7026, EAN 4047728070263



Mobile work bench with specialty tool assortment

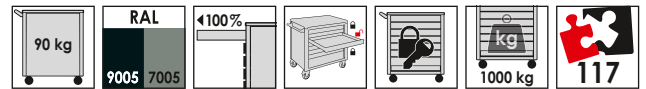

Variants fitted with drawers

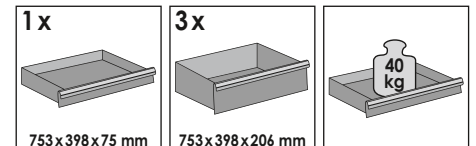

Delivery without pull-handle

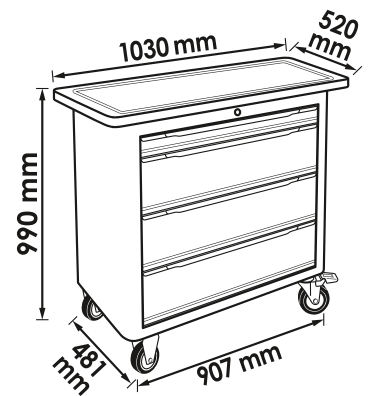

6,790.- € excl. VAT

+ assortment

V7201



V4906



V4921



V5549-1N



V4904



V4908



V5741N



V5066



V5009



V7026-1, EAN 4047728070386

VIGOR
SERIES **XL**

Mobile work bench with specialty tool assortment

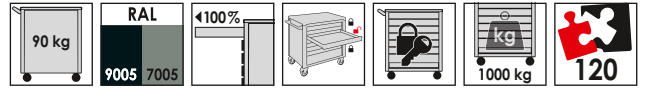

Variants fitted with drawers

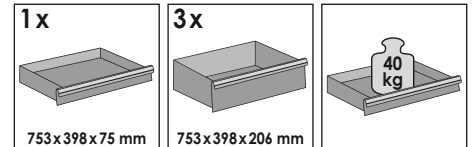

Delivery without pull-handle

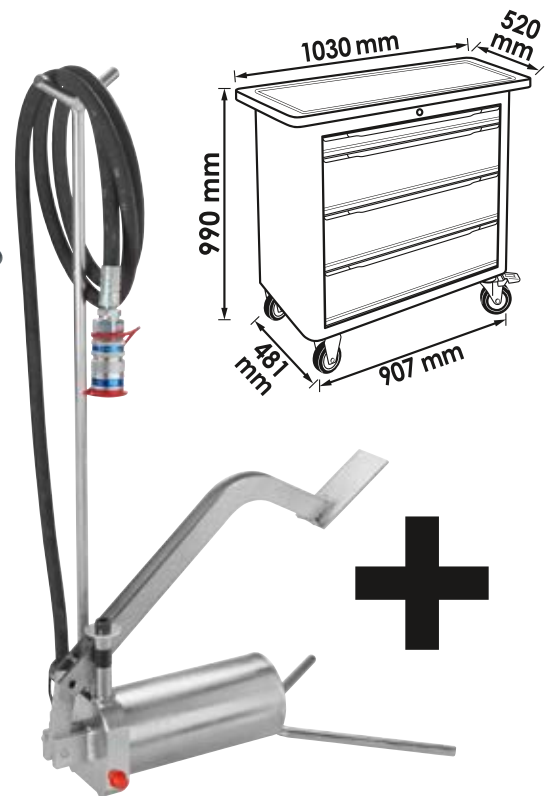

7,114.- €
excl. VAT

+ assortment
V7201

V4906

V4921

V5549-1N



V4904

V4908

V5741N

V5066

V5009



Mobile work benches with specialty tool assortment



V7026-2, EAN 4047728070478



Mobile work bench with specialty tool assortment

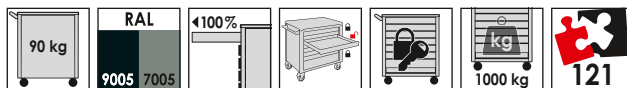

Variants fitted with drawers

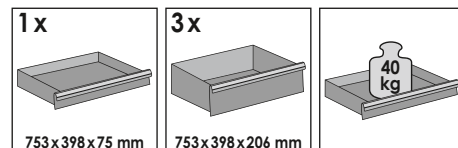

Delivery without pull-handle

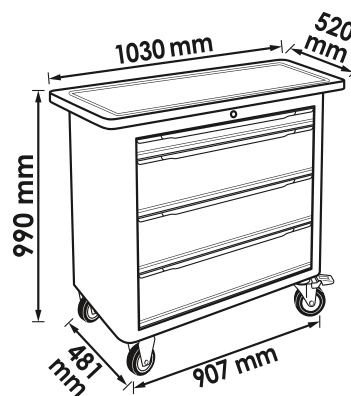

7,329.- €
excl. VAT

+ assortment
V7201



V4906



V4921

V5549-1N



V4904



V4908



V5741N



V5066



V5009



V7276, EAN 4047728072762

VIGOR
SERIES **XL**

Mobile work bench with specialty tool assortment

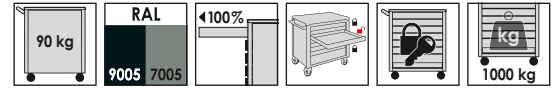

Variants fitted with drawers

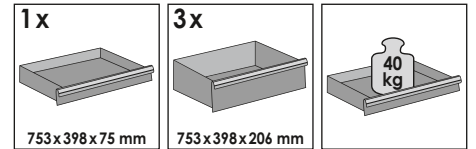

Delivery without pull-handle

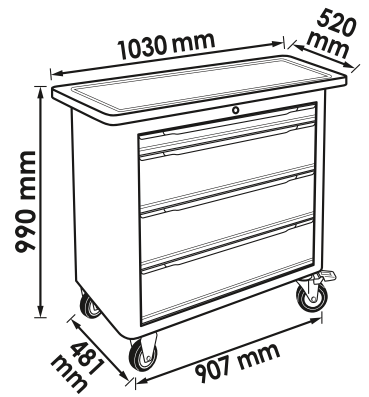

8,515.- €
excl. VAT

+ assortment

V4678



V7133N



V5058



V7261



V7265



V7267



V7270



V7273



V7263



Mobile work benches with specialty tool assortment



V7276-2, EAN 4047728072908



Mobile work bench with specialty tool assortment

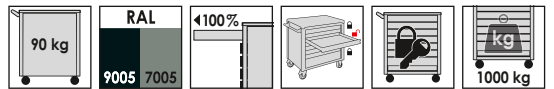

Variants fitted with drawers

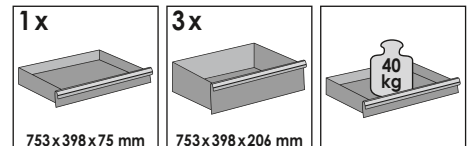

Delivery without pull-handle

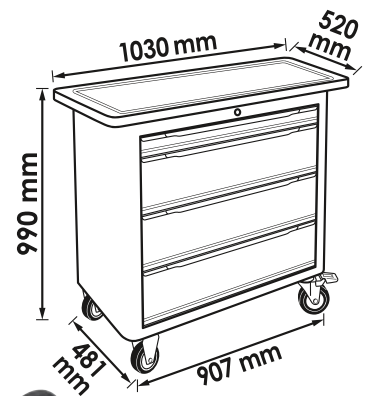

9,162.- €
excl. VAT



+ assortment

V4678



V7133N



V5058



V7261



V7265



V7267



V7270



V7273



V7263



Description of icons

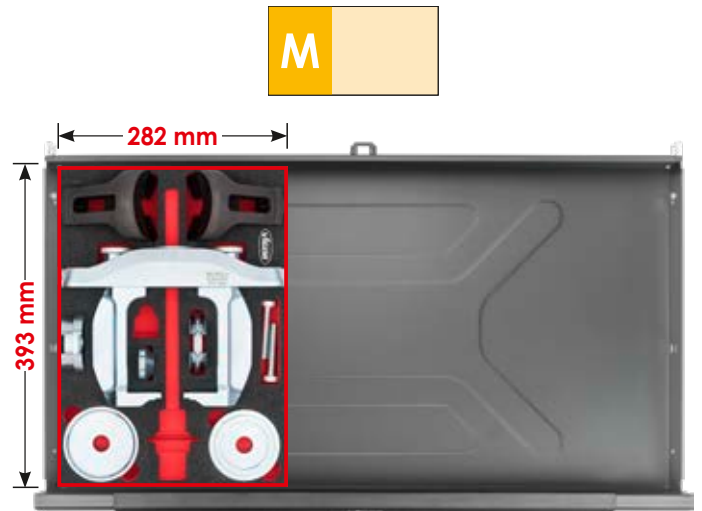
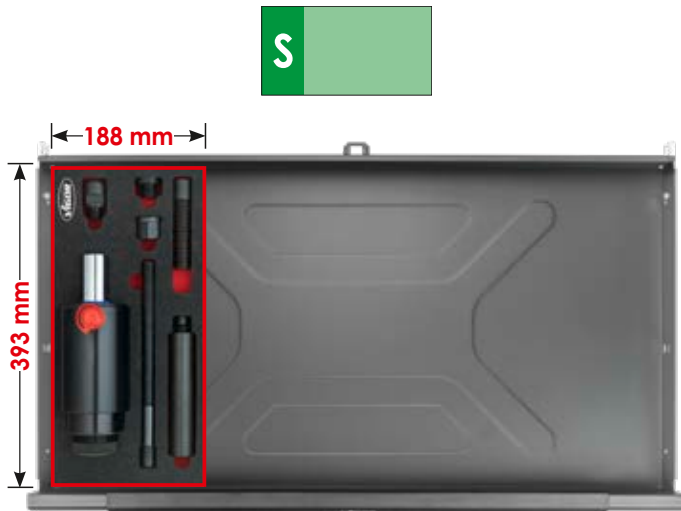

V5064, EAN 4047728050647
Tractive and compressive hydraulic cylinder 18 tonnes

895.- €
excl. VAT



V5058-L, EAN 4047728050579
Soft foam insert · empty



27.49 €
excl. VAT

V5058, EAN 4047728050586
Tractive and compressive hydraulic cylinder 22 tonnes

930.50 €
excl. VAT



V5085-L, EAN 4047728050869
Soft foam insert · empty



38.27 €
excl. VAT

Special soft foam inserts



V4908, EAN 4047728049085
Bearing/hub shell set including
wheel bearing fixation



408.- €
excl. VAT



V4908-L, EAN 4047728049078
Soft foam insert · empty



27.49 €
excl. VAT

V4915, EAN 4047728049153
Pressure foot set

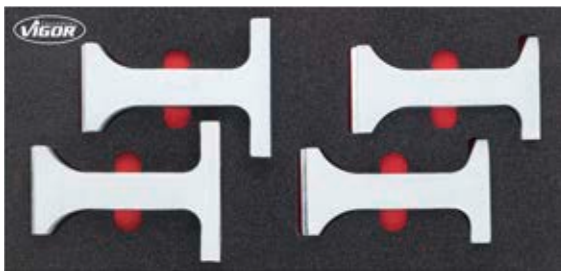

674.- €
excl. VAT



V4915-L, EAN 4047728049146
Soft foam insert · empty



27.49 €
excl. VAT

V5062, EAN 4047728050623
Drive shaft tool set

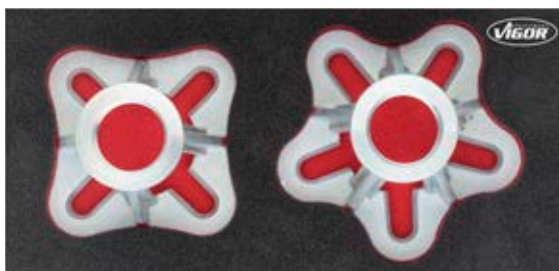

569.- €
excl. VAT



V5062-L, EAN 4047728050616
Soft foam insert · empty



27.49 €
excl. VAT

V4921, EAN 4047728049214
Inner bearing ring puller including circlip tool



348.- €
excl. VAT



V4921-L, EAN 4047728049207
Soft foam insert · empty



27.49 €
excl. VAT



V4917, EAN 4047728**049177**
Cardan shaft puller · universal

82.⁹⁰ €
excl. VAT

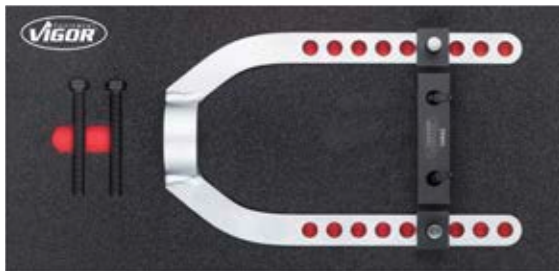

V4917-L, EAN 4047728**049160**
Soft foam insert · empty



27.⁴⁹ €
excl. VAT

V7263, EAN 4047728**072649**
Wheel bearing tool set · front · IVECO Daily 2014
 • Replacement of the front wheel bearing in IVECO Daily models, model year 2014→

463.⁵⁰ €
excl. VAT

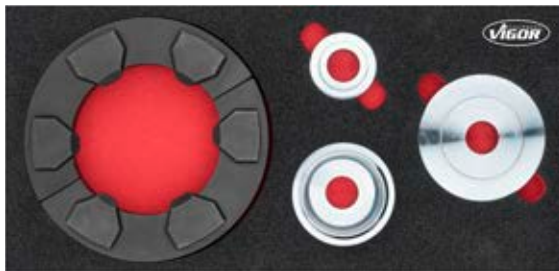

V7263-L, EAN 4047728**072632**
Soft foam insert · empty



27.⁴⁹ €
excl. VAT

V7267, EAN 4047728**072687**
Wheel hubs expansion set / remove wheel bearings
 • Wheel hubs expansion set / remove wheel bearings

662.- €
excl. VAT



V7267-L, EAN 4047728**072670**
Soft foam insert · empty



27.⁴⁹ €
excl. VAT

Special soft foam inserts



V4906, EAN 4047728049061
 Universal wheel hub / bearing
 installation and removal set

1,104.- €
excl. VAT



V4906-L, EAN 4047728049054
 Soft foam insert · empty



38.27 €
excl. VAT

V7201, EAN 4047728072014
 Compact wheel bearing removal / installation set · universal
 • For removing and installing compact wheel bearings with or without circlip
 • Adjustability guarantees use of all types of current and future compact wheel bearings available on the market

1,127.- €
excl. VAT



V7201-L, EAN 4047728072021
 Soft foam insert · empty



38.27 €
excl. VAT

V4904, EAN 4047728049047
 Set of devices for the removal of drive shafts

1,282.- €
excl. VAT



V4904-L, EAN 4047728049023
 Soft foam insert · empty



38.27 €
excl. VAT



V5066, EAN 4047728050661

Pressure sleeve set

678.- €
excl. VAT



V5066-L, EAN 4047728050654

Soft foam insert · empty



38.27 €
excl. VAT

V5549-1N, EAN 4047728075909

Compact wheel bearing and wheel hub expansion set

1,137.- €
excl. VAT



NEW



V5549-1-NL, EAN 4047728075510

Soft foam insert · empty



38.27 €
excl. VAT

V7261, EAN 4047728072625

Expansion set for transporter tools

• Extension for transporter tools

772.50 €
excl. VAT



V7261-L, EAN 4047728072618

Soft foam insert · empty



38.27 €
excl. VAT

Special soft foam inserts



V7265, EAN 4047728**072663**
Cylinder set 32 tonnes and 8.8 tonnes

2,209.- €
excl. VAT



V7265-L, EAN 4047728**072656**
Soft foam insert · empty



38.27 €
excl. VAT

V7270, EAN 4047728**072717**
Rear axle expansion set

• Expansion set for changing rear axle wheel bearings in the following vehicles: CITROËN Jumper · FIAT Ducato · PEUGEOT Boxer · FORD Transit

1,104.- €
excl. VAT



V7270-L, EAN 4047728**072700**
Soft foam insert · empty

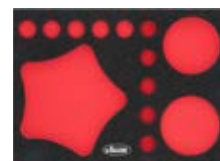

38.27 €
excl. VAT

V7273, EAN 4047728**072748**
Transport vehicle starter set

• Considerable time savings thanks to usability directly on the vehicle · estimated time per side is approx. 30-40 minutes

2,047.- €
excl. VAT



V7273-L, EAN 4047728**072731**
Soft foam insert · empty



38.27 €
excl. VAT



V2889, EAN 4047728028899

Wheel bearing tool set · front · CITROËN · FIAT · PEUGEOT

- For e.g.:
 - CITROËN: Jumper model year → 2007
 - FIAT: Ducato model year → 2007
 - PEUGEOT: Boxer model year → 2007
- Changing of wheel bearings directly on the vehicle in the minimum amount of time
- Disassembly of wheel hubs and bearings on the chassis with the aid of the 32 tonne hydraulic cylinder (V2874) together with impact force
- Working time: 30–40 minutes per side
- Application only in conjunction with bearing washer (V2881) and support disc (V2882)
- For models since 2007 pressure ring V2883 must be used



VIGOR No.	Designation	Design	← L → mm	EAN 4047728+	€
V3105	Pressure ring		-	031059	231.-
V3107	Pressure pipe		180	031073	284.50
V3149	Pressure pipe		115	031493	55.30
V3091	Support disc · inside Ø 23 mm · suitable for M 22 spindle		-	030915	51.42
V3108	Bearing washer · inside Ø 23 mm · suitable for M 22 spindle		-	031080	148.-
V3109	Counterholder		-	031097	163.-
V3106	Thrust washer · Ø 170 mm		-	031066	208.50



873.- €
excl. VAT

Pressure ring for wheel bearing tool set · front · CITROËN · FIAT · PEUGEOT

- Supplementary tool for e.g.:
 - CITROËN Jumper model year 2007 →
 - FIAT Ducato model year 2007 →
 - PEUGEOT Boxer model year 2007 →
- For vehicles model year 2007 → – use with V2889
- This pressure ring set must be used instead of pressure ring set V3105

VIGOR No.	EAN 4047728+	€
V2883	028837	348.-



Bearing washer for wheel bearing tool set · front · CITROËN · FIAT · PEUGEOT

- Required for wheel bearing tool set, front (V2889) if wheel bearing tool set rear (V2880) is not available

VIGOR No.	EAN 4047728+	€
V2881	028813	100.50

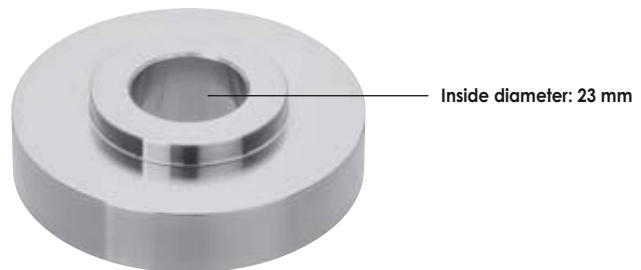

Support disc for wheel bearing tool set · front · CITROËN · FIAT · PEUGEOT

- Required for wheel bearing tool set, front (V2889) if wheel bearing tool set rear (V2880) is not available

VIGOR No.	EAN 4047728+	€
V2882	028820	60.91

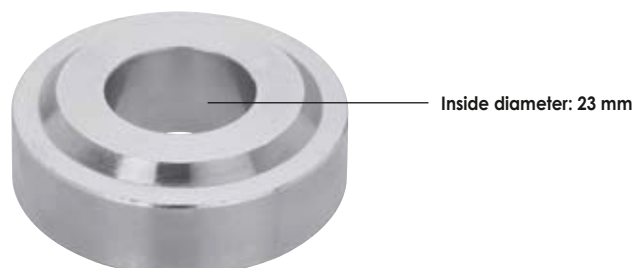

V2888, EAN 4047728028882

Wheel bearing tool set · front · NISSAN · OPEL/VAUXHALL · RENAULT

- For e.g. (model year 2002 → 2010):
 - NISSAN: Interstar
 - OPEL: Movano
 - RENAULT: Master
- Changing of front wheel bearing directly on the vehicle
- The bearing is removed from the vehicle interior
- Working time: 40 minutes per side



VIGOR No.	Designation	Design	mm	EAN 4047728+	€
V3112	Bearing shell		-	031127	265.50
V3107	Pressure pipe		180	031073	284.50
V3149	Pressure pipe		115	031493	55.30
V3110	Thrust washer · Ø 89 mm		-	031103	102.50
V3113	Pressure ring set Ø 89 mm		-	031134	363.50
V3106	Thrust washer · Ø 170 mm		-	031066	208.50
V3111	Thrust washer		-	031110	85.49
V2881	Bearing washer for CITROËN · FIAT · PEUGEOT wheel bearing tool set · front · inside Ø 23 mm · suitable for M 22 spindle		-	028813	100.50
V3088	Support disc · inside Ø 23 mm · suitable for M 22 spindle		-	030885	55.30

1,159.- € excl. VAT

Pressure sleeve

- Supplementary tool for a/m models 2010 →
- This pressure sleeve must be used instead of bearing shell V3112



VIGOR No.	EAN 4047728+	€
V3433	034333	161.50

Pressure ring for wheel bearing tool set · front · CITROËN · FIAT · PEUGEOT

- Supplementary tool for e.g.:
 - CITROËN Jumper model year 2007 →
 - FIAT Ducato model year 2007 →
 - PEUGEOT Boxer model year 2007 →
- For vehicles model year 2007 → – use with V2889
- This pressure ring set must be used instead of pressure ring set V3105



VIGOR No.	EAN 4047728+	€
V2883	028837	348.-



V7252, EAN 4047728072526

Wheel bearing tool set · front · IVECO Daily 2014

- Replacement of the front wheel bearing in IVECO Daily models, model year 2014→
- Considerable time savings thanks to usability directly on the vehicle without prior removal of the axle parts approx. 30 - 40 minutes of work per side
- Receiving adapter for pressure sleeves designed for the safe and deformation-free replacement of the wheel bearing
- Set to be used together with the hydraulic cylinder V2874
- Working under the workshop press is also an option



NEW



799.- €
excl. VAT

V2879, EAN 4047728028790

Wheel bearing tool set · front, FORD

- Changing the wheel bearing on the front axle
- For FORD Transit (Tourneo) model year 2000→
- Changing the brake disc without damaging the wheel bearing
- For wheel bearings with 78 mm Ø and 87.5 mm Ø
- Working time: approx. 25 minutes per side
- Changing of wheel bearings directly on the vehicle in the minimum amount of time



591.90 €
excl. VAT

V2890, EAN 4047728028905

Drive shaft tool, 5 holes, for transport vehicles

- For removing rusted and glued drive shafts directly on the vehicle
- For vans with 5-hole wheel hub due to eccentric holes for wheel bolts
- For bolt circle 119 – 172 mm
- Prevents heating, splitting of the drive shaft or damage to other parts

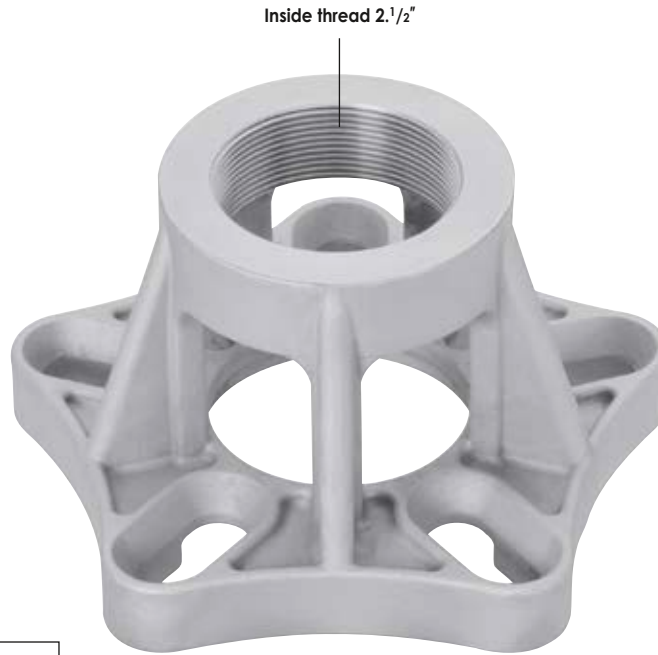

**Working time:
approx. 5 minutes only**

580.- €
excl. VAT

V3287, EAN 4047728032872

Special nut · M 16x1.5 mm

- Used together with the drive shaft tool V2890 for the removal of wheel bearings (rear) or for pressing out the drive shafts (front)
- For
 - CITROËN Jumper
 - PEUGEOT Boxer
 - FIAT Ducato
 - RENAULT Master
- 5 nuts required



Price per piece

48.62 €
excl. VAT

V3013, EAN 4047728030137

Special nut · M 14x2 mm

- Used together with the drive shaft tool V2890 for the removal of wheel bearings (rear) or for pressing out the drive shafts (front)
- For FORD Transit
- 5 nuts required



Price per piece

50.88 €
excl. VAT



V7251, EAN 4047728072540

Multibox wheel bearing tool set IVECO Daily

- Replacement of the front axle wheel bearings while installed in the IVEVO Daily from model year 2014
- To be used with 32 t Hydraulic Cylinder V2874
- Alternative use after removal with the aid of a workshop press



VIGOR No.	Designation	Design	mm	EAN 4047728+	€
V7251-1	Pressure ring, IVECO Daily		-	072557	291.-
V7251-2	Large pressure pipe		-	072519	87.10
V7251-3	Bearing washer, IVECO Daily		-	072564	49.70
V7251-4	Support disc, IVECO Daily		-	072571	41.83
V7251-5	Bearing shell, IVECO Daily		-	072588	59.72
V3106	Thrust washer · Ø 170 mm		-	031066	208.50
V3108	Bearing washer · inside Ø 23 mm · suitable for M 22 spindle		-	031080	148.-
V3149	Pressure pipe		115	031493	55.30

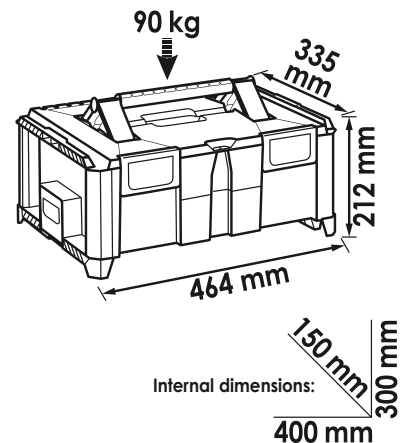

861.- €
excl. VAT

Commercial vehicle tool sets



V7275, EAN 4047728**072755**

Multibox · starter set · wheel bearing of van front axle

• Considerable time savings thanks to usability directly on the vehicle · estimated time per side is approx. 30-40 minutes



VIGOR No.	Designation	Design	l mm	XX	EAN 4047728+	€
V3433	Pressure sleeve · inside Ø 23 mm · suitable for M 22 spindle		-	1	034333	161.50
V7251-2	Large pressure pipe		-	-	072519	87.10
V3106	Thrust washer · Ø 170 mm		-	1	031066	208.50
V2883	Pressure ring for wheel bearing tool set · front · CITROËN · FIAT · PEUGEOT		-	4	028837	348.-
V2881	Bearing washer for CITROËN · FIAT · PEUGEOT wheel bearing tool set · front · inside Ø 23 mm · suitable for M 22 spindle		-	1	028813	100.50
V3108	Bearing washer · inside Ø 23 mm · suitable for M 22 spindle		-	1	031080	148.-
V3109	Counterholder		-	1	031097	163.-
V2882	Support disc for CITROËN · FIAT · PEUGEOT wheel bearing tool set · front		-	1	028820	60.91
V3149	Pressure pipe		115	1	031493	55.30
V3091	Support disc · inside Ø 23 mm · suitable for M 22 spindle		-	1	030915	51.42
V3110	Thrust washer · Ø 89 mm		-	1	031103	102.50
V3039	Thrust washer · large		-	1	030397	102.50
V3040	Pressure pipe · large		120	1	030403	168.-
V3087	Wheel hub tool		-	1	030878	461.50
V3088	Support disc · inside Ø 23 mm · suitable for M 22 spindle		-	1	030885	55.30

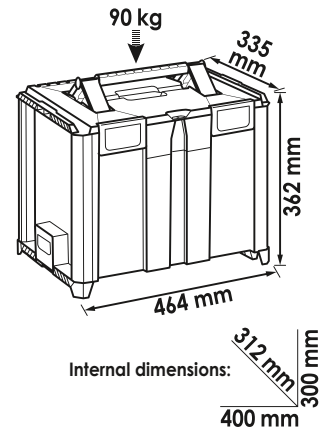

1,800.- € excl. VAT



V7291, EAN 4047728072915

Multibox · expansion set · wheel bearing of van rear axle / drive shaft

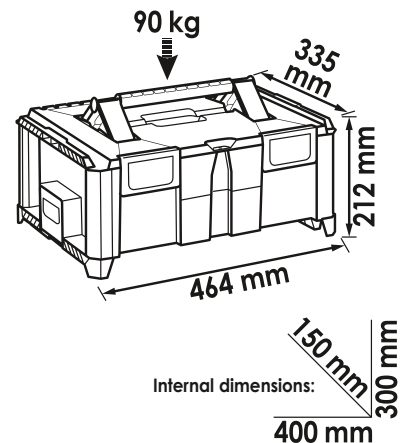

VIGOR No.	Designation	Design		EAN 4047728+	€
V3013	Special nut · M 14x2 mm		5	030137	50.88
V3287	Special nut · M 16x1.5 mm		-	032872	48.62
V2890	Drive shaft tool, 5 holes, for transport vehicles		1	028905	580.-
V3021	Pressure sleeve		1	030212	132.50
V3090	Adapter ring		1	030908	139.-

2,098.- € excl. VAT

V2858N, EAN 4047728075268

Press frame

- Maximum load of the supporting joints and press frame: 18 t
- Only in conjunction with V2913 · V2915 · V2914
- For e.g.: FORD and MERCEDES-BENZ



NEW

298.39 €
excl. VAT

V2920, EAN 4047728029209

Ball joint puller · universal

- For removing the ball joint pivots from steering arms on vans, trucks and buses

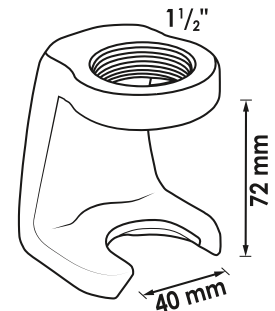

314.- €
excl. VAT

V3678, EAN 4047728036788

Brake disc removal (floating) ·

Volvo · RENAULT · DAF

- Removal of floating brake discs
- Removal of the brake disc by alternately pressing the cylinders
- Two special cylinders and two-way control valves for alternate pressing
- Brake disc removal in just a few minutes

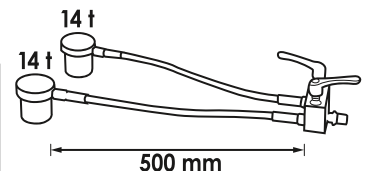

1,514.- €
excl. VAT



V4565, EAN 4047728**045650**

King pin removal set 32 tonnes · universal

- For almost all common king pins, also for tapered models
- Unique impact function enables removal with hammer strokes on the cylinder (with mounted impact body) in direction of actuation
- Very effective impact function transmits the vibrations required for successful removal to the material
- Removal of the axle is not necessary
- 32 tonne-version
- Easy to use, also suitable for buses, where access is often restricted

Inside thread 2.1/2"



VIGOR No.	Designation	Design	l mm	EAN 4047728+	€
V4550	Press frame for V4565 · V4566		-	045506	2,005.-
V3266	Pressure pipe		130	032667	125.50
V4564	Pressure pipe 85 mm for V4565 · V4566		85	045643	109.50
V3267	Pressure pipe		42	032674	125.50
V4634	Pressure pipe for V4565 · V4566		-	046343	109.50
V4562	Pressure sleeve for V4565 · V4566		-	045629	75.57
V4563	Adapter plate for V4565 · V4566		-	045636	98.64
V3264	Thrust rod · 250 mm Ø 31 mm		250	032643	249.50
V3265	Thrust rod · 140 mm Ø 31 mm		140	032650	213.-
V3232	Thrust rod · 50 mm Ø 31 mm		50	032322	115.50



2,911.- €
excl. VAT

V4566, EAN 4047728**045667**

King pin removal set 45 tonnes · universal

- For almost all common king pins, also for tapered models
- Unique impact function enables removal with hammer strokes on the cylinder (with mounted impact body) in direction of actuation
- Very effective impact function transmits the vibrations required for successful removal to the material
- Removal of the axle is not necessary
- 45 tonne-version
- Easy to use, also suitable for buses, where access is often restricted



VIGOR No.	Designation	Design	mm	EAN 4047728+	€
V4550	Press frame for V4565 · V4566		-	045506	2,005.-
V3266	Pressure pipe		130	032667	125.50
V4564	Pressure pipe 85 mm for V4565 · V4566		85	045643	109.50
V3267	Pressure pipe		42	032674	125.50
V4634	Pressure pipe for V4565 · V4566		-	046343	109.50
V4562	Pressure sleeve for V4565 · V4566		-	045629	75.57
V4563	Adapter plate for V4565 · V4566		-	045636	98.64
V4546	Thrust rod · M 30 · length 140 mm · Ø 38 mm		140	045469	201.-
V4545	Thrust rod · M 30 · length 30 mm · Ø 38 mm		30	045452	116.-
V4549	Extension · 100 mm · Ø 38 mm for V4555 · V4566		100	045490	116.-
V4548	Extension · 70 mm · Ø 38 mm for V4555 · V4566		70	045483	99.50
V4547	Extension · 50 mm · Ø 38 mm for V4555 · V4566		50	045476	81.82

2,841.- € excl. VAT

V4569, EAN 4047728045698

King pin removal expansion set

- Expansion set for the items V4565 and V4566
- The system allows the extraction and insertion of king pins on trailers without removing the axle in advance



VIGOR No.	Designation	Design	EAN 4047728+	€
V4571	Extension for V4569		045711	91.31
V4575	Extension for V4569		045759	91.31 **
V4572	Extension for V4569		045728	91.31
V4573	Pressure plate for V4569		045735	91.31
V4574	Pressure plate for V4569		045742	91.31
V4570	Support for V4569		045704	181.50 *

* Price per piece ** Price per set

872.- €
excl. VAT

V4605, EAN 4047728046053

King pin removal expansion set MERCEDES-BENZ Actros und Atego

- Expansion set for the items V4565 and V4566
- The system allows the extraction and insertion of king pins to be carried out directly on the vehicle



VIGOR No.	Designation	Design	mm	EAN 4047728+	€
V4575	Extension for V4569		-	045759	91.31 *
V4609	Thrust rod · M 30 · length 137 mm · Ø 29 mm · for V4605 · V602		137	046091	205.50
V4572	Extension for V4569		-	045728	91.31
V4607	Guide ring for V4605 · V4606		-	046077	79.13
V4610	Centring thrust block		-	046107	60.91

* Price per piece

611.- €
excl. VAT

V4606, EAN 4047728046060

Steering knuckle removal expansion set MAN TGA · TGX and TGS

- Expansion set for the items V4565 and V4566
- The system allows the extraction and insertion of king pins to be carried out directly on the vehicle



VIGOR No.	Designation	Design	EAN 4047728+	€
V4608	Pressure pipe		046084	193.50
V4575	Extension for V4569		045759	91.31 *
V4572	Extension for V4569		045728	91.31
V4607	Guide ring for V4605 · V4606		046077	79.13

* Price per piece ** Price per set

507.- €
excl. VAT

V4554, EAN 4047728045544

Wheel hub puller set for trucks · buses and trailers 32 tonnes

- Wheel hubs of trucks with 8 bolts, 275 mm, or 10 bolts, 335 mm
- Removing wheel hubs with compact bearings, e.g. on SAF axles
- Sturdy construction facilitates the full power of 32 tonnes together with impact force when removing the wheel hub



VIGOR No.	Designation	Design	mm	XX	EAN 4047728+	€
V3263	Screw · M 22x60 mm		-	8	032636	29.32
V4556	Plate with thread for V3750 · V4554 · V4555		-	1	045568	840.-
V3265	Thrust rod · 140 mm Ø 31 mm		140	1	032650	213.-
V3232	Thrust rod · 50 mm Ø 31 mm		50	1	032322	115.50
V3222	Pressure foot		-	2	032223	376.-
V3231	Pressure plate		-	1	032315	83.98
V3264	Thrust rod · 250 mm Ø 31 mm		250	1	032643	249.50

1,768.- €
excl. VAT

V4555, EAN 4047728045551

Wheel hub puller set for trucks · buses and trailers 45 tonnes

- Wheel hubs of trucks with 8 bolts, 275 mm, or 10 bolts, 335 mm
- Removing wheel hubs with compact bearings, e.g. on SAF axles
- Sturdy construction facilitates the full power of 45 tonnes together with impact force when removing the wheel hub



VIGOR No.	Designation	Design	mm	XX	EAN 4047728+	€
V3263	Screw · M 22x60 mm		-	8	032636	29.32
V4556	Plate with thread for V3750 · V4554 · V4555		-	1	045568	840.-
V3222	Pressure foot		-	2	032223	376.-
V4546	Thrust rod · M 30 · length 140 mm · Ø 38 mm		140	1	045469	201.-
V4545	Thrust rod · M 30 · length 30 mm · Ø 38 mm		30	1	045452	116.-
V4549	Extension · 100 mm · Ø 38 mm for V4555 · V4566		100	1	045490	116.-
V4547	Extension · 50 mm · Ø 38 mm for V4555 · V4566		50	1	045476	81.82
V4548	Extension · 70 mm · Ø 38 mm for V4555 · V4566		70	1	045483	99.50

1,768.- €
excl. VAT



V3634, EAN 4047728036344

Spacer screw M 22

- To be used together with wheel hub puller set V2934 on axles with planetary gear in the wheel hub
- Supplied without pictured plate (V2932)
- 4 spacer screws required for use with V2934
- Height: 50 mm



Planetary gear



63.28 €
excl. VAT

V3434, EAN 4047728034340

Wheel bearing tool set for SCANIA

- Faster, easier change of the wheel bearing directly on the vehicle
- Only together with wheel hub puller set V4554
- Striker nut included enables removal using the impact function



Only together with wheel hub puller set V4554



VIGOR No.	Designation	Design	mm	EAN 4047728+	€
V3431	Drawbar · M 22		500	034319	125.50
V3439	Protective sleeve		-	034395	113.-
V3440	Pressure sleeve		65	034401	75.89
V3437*	Thrust washer · Ø 130 mm		-	034371	177.-
V3438*	Thrust washer · Ø 125 mm		-	034388	177.-
V3132	Flange nut · M 22x2.5		-	031325	57.03
V3092	Striker nut		-	030922	87.43



662.- €
excl. VAT

* Inside diameter 23 mm suitable for M 22 spindle

V4499, EAN 4047728**044998**

Wheel hub puller commercial vehicle · 32 tonnes

- Removal of rusted bearings with outside wheel hubs from straight shafts
- For: Volvo FL · TGS · TGX · MERCEDES-BENZ Atego · Actros · RENAULT Kerax · Magnum · Midlum · Premium
- Can also be used for vehicles with identical construction



VIGOR No.	Designation	Design	EAN 4047728+	€
V3867	Adapter for base component with thread		038676	378.-
V3761	Base component with thread		037617	485.-
V3762	Thrust rod · M 24		037624	140.-

873.- €
excl. VAT

V4500, EAN 4047728**045001**

Wheel hub puller commercial vehicle · 45 tonnes

- Removal of rusted bearings with outside wheel hubs from straight shafts
- For: Volvo FL · TGS · TGX · MERCEDES-BENZ Atego · Actros · RENAULT Kerax · Magnum · Midlum · Premium
- Can also be used for vehicles with identical construction



VIGOR No.	Designation	Design	EAN 4047728+	€
V3867	Adapter for base component with thread		038676	378.-
V3761	Base component with thread		037617	485.-
V4577	Thrust rod · M 30 for V4500		045773	157.-

873.- €
excl. VAT



V3750, EAN 4047728**037501**

Wheel hub extractor for low-height trailers

- Removal of 225 mm wheel hub with 10 screws
- Extractor enables loosening of hubs with bearing unit on straight shafts



To be used with threaded plate V4556 (not included), only



VIGOR No.	Designation	Design		EAN 4047728+	€
V3263	Screw · M 22x60 mm		8	032636	29.32**
V3763	Plate		2	037631	285.50*
V3764	Leg		4	037648	116.-**
V3765	Thrust washer · SAF Ø 73 mm		1	037655	116.-*

1,050.- €
excl. VAT

* Price per piece ** Price per set

V4601, EAN 4047728046015

Spring bolt set for SCANIA 32 tonnes

- Removing spring bolts
- To be used with plate V4556 for press frame and 32 tonne hydraulic cylinder V2874 (not included)
- Use the integrated impact function in the event of rusted bolts (often essential for successful removal)
- Work directly on the vehicle with minimal removal of parts



VIGOR No.	Designation	Design	mm	XX	EAN 4047728+	€
V3262	Press frame		-	3	032629	1,214.-
V3259	Pressure pipe · large		60	1	032599	125.50
V3261	Thrust rod · 115 mm Ø 29 mm		115	1	032612	188.50
V3263	Screw · M 22x60 mm		-	8	032636	29.32*
V3260	Thrust rod · 100 mm Ø 29 mm		100	1	032605	87.43

* Price per piece

1,400.- €
excl. VAT

V4602, EAN 4047728046022

Spring bolt set for SCANIA 45 tonnes

- Removing spring bolts
- To be used with plate V4556 for press frame and 45 tonne hydraulic cylinder V4242 (not included)
- Use the integrated impact function in the event of rusted bolts (often essential for successful removal)
- Work directly on the vehicle with minimal removal of parts



VIGOR No.	Designation	Design	mm	XX	EAN 4047728+	€
V3262	Press frame		-	3	032629	1,214.-
V3259	Pressure pipe · large		60	1	032599	125.50
V4609	Thrust rod · M 30 · length 137 mm · Ø 29 mm · for V4605 · V602		137	1	046091	205.50
V3263	Screw · M 22x60 mm		-	8	032636	29.32*
V4602-1	Thrust rod length 64 mm Ø 29 mm		64	2	046336	181.50

* Price per piece

1,400.- €
excl. VAT



V2937, EAN 4047728029377

Brake adjuster puller

- Removing rusted camshafts of brake adjusters
- Suitable for almost all common lever arms, also Haldex and BPW
- Very compact design guarantees flexible use in areas with restricted access

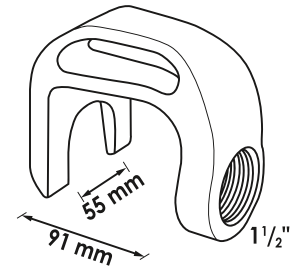
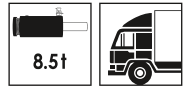

Inside thread 1.1/2"

453.- €
excl. VAT



V4635, EAN 4047728046350

Spring bushing set · universal

- Allows changing of spring bushings without unnecessary disassembly
- Tools for removing the joint spring bushings included
- For bushings size 44 to 63 mm
- Easy removal of even rusted bushings due to impact function



VIGOR No.	Designation	Design	mm	EAN 4047728+	€
V3127	Drawbar · M 18 M 22 · maximum 22 t		250	031271	69.75
V3126	Flange nut · M 18x2.5		-	031264	41.83
V3266	Pressure pipe		130	032667	125.50
V3267	Pressure pipe		42	032674	125.50
V3235*	Thrust washer · Ø 44 mm		-	032353	87.43
V3236*	Thrust washer · Ø 50 mm		-	032360	87.43
V3233*	Thrust washer · Ø 57 mm		-	032339	87.43
V3237*	Thrust washer · Ø 63 mm		-	032377	94.97
V3234*	Thrust washer · Ø 63 mm		-	032346	94.97

701.50 €
excl. VAT

* Inside diameter 23 mm suitable for M 22 spindle

V2936, EAN 4047728029360

Bushing set · for SAF axle · 150 mm

- Quick, easy removal / fitting of the large rubber bushings 150 mm on SAF axles

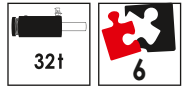

VIGOR No.	Designation	Design	← L → mm	EAN 4047728+	€
V3107	Pressure pipe		180	031073	284.50
V3225	Dismounting/mounting ring		-	032254	125.50
V3106*	Thrust washer · Ø 170 mm		-	031066	208.50
V3224*	Dismounting/mounting washer		-	032247	125.50
V3226	Assembly ring		-	032261	163.-
V3431	Drawbar · M 22		500	034319	125.50

* Inside diameter 23 mm suitable for M 22 spindle

718.50 €
excl. VAT

V2942, EAN 4047728029421

Bushing set for drawbars

- Changing bushings with a 32 tonne hydraulic cylinder V2874 (not included) with impact function directly on the drawbar
- For universal use, especially for VBG bushings and drawbars
- Change bushings without heating or other treatment



VIGOR No.	Designation	Design	← L → mm	EAN 4047728+	€
V3266	Pressure pipe		130	032667	125.50
V3267	Pressure pipe		42	032674	125.50
V3238*	Thrust washer		-	032384	87.43

* Inside diameter 23 mm suitable for M 22 spindle

485.- €
excl. VAT



V4603, EAN 4047728**046039**

Universal pressure tool set 32 tonnes · universal

- Quick changing of tapered and cylindrical king pins, spring bushings, drawbar bolts as well as large circlips
- Contents:
 - Removal tools for ball joints, brake adjuster, VBG-drawbar bolts
 - Tools for removing wheel hubs
 - 8.5 tonnes and 32 tonnes hydraulic cylinder with spindle and impact body



VIGOR No.	Designation	Design	mm	XX	EAN 4047728+	€
V3222	Pressure foot		-	2	032223	376.-
V3263	Screw · M 22x60 mm		-	8	032636	29.32
V2867	Circlip tool		-	7	028677	160.50
V2920	Ball joint puller · universal		-	1	029209	314.-
V2873	Tractive and compressive hydraulic cylinder 8.5 tonnes		106	4	028738	508.50
V5916-XL	Ball joint ejector · hydraulic 8.8 tonnes		-	3	066471	1,159.-
V2874	Tractive and compressive hydraulic cylinder 32 tonnes		223	8	028745	1,137.-
V3238	Thrust washer		-	1	032384	87.43
V3237	Thrust washer · Ø 63 mm		-	1	032377	94.97
V3236	Thrust washer · Ø 50 mm		-	1	032360	87.43
V3235	Thrust washer · Ø 44 mm		-	1	032353	87.43
V3234	Thrust washer · Ø 63 mm		-	1	032346	94.97
V3233	Thrust washer · Ø 57 mm		-	1	032339	87.43
V3231	Pressure plate		-	1	032315	83.98
V3126	Flange nut · M 18x2.5		-	1	031264	41.83
V3127	Drawbar · M 18 M 22 · maximum 22 t		250	1	031271	69.75
V4565	King pin removal set 32 tonnes · universal		-	10	045650	2,911.-



6,818.- €
excl. VAT

Commercial vehicle tool sets



V4604, EAN 4047728**046046**

Universal pressure tool set 45 tonnes · universal

- Quick changing of tapered and cylindrical king pins, drawbar bolts as well as large circlips
- Contents:
 - Removal tools for ball joints, brake adjuster, VBG-drawbar bolts
 - Tools for removing wheel hubs
 - 8.5 tonnes and 45 tonnes hydraulic cylinder with spindle and impact body

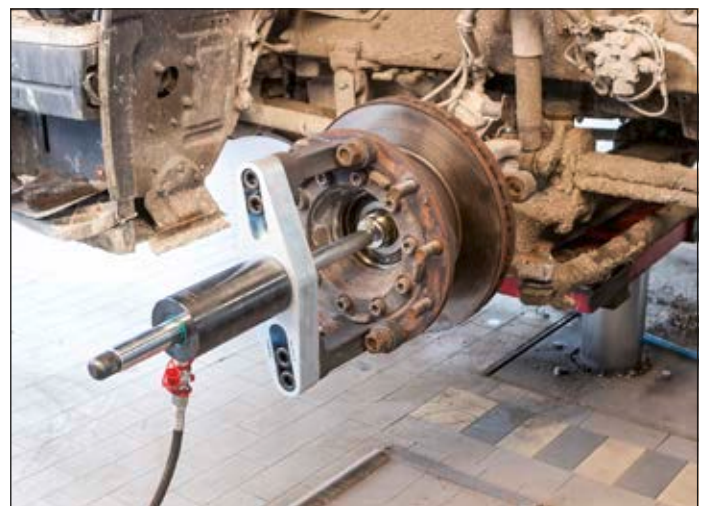

VIGOR No.	Designation	Design	mm	XX	EAN 4047728+	€
V3222	Pressure foot		-	2	032223	376.-
V3263	Screw · M 22x60 mm		-	8	032636	29.32
V2867	Circlip tool		-	7	028677	160.50
V5916-XL	Ball joint ejector · hydraulic 8.8 tonnes		-	3	066471	1,159.-
V2873	Tractive and compressive hydraulic cylinder 8.5 tonnes		106	4	028738	508.50
V4229	Tractive and compressive hydraulic cylinder 45 tonnes		214	7	042291	1,712.-
V4566	King pin removal set 45 tonnes · universal		-	12	045667	2,841.-

6,790.- €
excl. VAT



Wallmek-No	VIGOR No.	Designation	Page
01-00001-001	V2945	Adapter plate for V2868	365
01-00001-002	V2946	Thrust rod · adjustable · 90 mm for V2868	365
01-00001-101	V2947	Pressure sleeve	364
01-00001-102	V2948	Pressure sleeve	364
01-00001-103	V2949	Pressure sleeve	364
01-00001-104	V2950	Pressure sleeve	364
01-00001-105	V2961	Pressure sleeve	364
01-00001-106	V2962	Pressure sleeve	364
01-00001-107	V2963	Pressure sleeve	365
01-00001-108	V2964	Pressure sleeve	365
01-00001-109	V2965	Pressure sleeve	365
01-00001-110	V2966	Pressure sleeve	365
01-00001-201	V2967	Pressure pipe	365
01-00001-202	V2968	Pressure pipe	365
01-00001-203	V2969	Pressure pipe	365, 368–369
01-00001-204	V2971	Pressure pipe	365
01-00001-205	V2972	Pressure pipe	365
01-00001-206	V2973	Pressure pipe	365
01-00001-207	V2974	Pressure pipe	365
01-00001-208	V2975	Pressure pipe	365
01-00001-209	V2976	Pressure pipe	365
01-00001-210	V2977	Pressure pipe	365
01-00001-211	V2978	Pressure pipe	365
01-00001-212	V2979	Pressure pipe	365
01-00001-213	V2980	Pressure pipe	365
01-00001-214	V2981	Pressure pipe	365
01-00001-400	V5169-A	Pressure sleeve expansion set	365
01-00001-401	V5169-A45	Adapter pressure sleeves · 45 mm	365
01-00001-402	V5169-A55	Adapter pressure sleeves · 55 mm	365
01-00001-403	V5169-A70	Adapter pressure sleeves · 70 mm	365
01-00001-404	V5169-A76	Adapter pressure sleeves · 76 mm	365
01-00001-405	V5169-A80	Adapter pressure sleeves · 80 mm	365
01-00001-999	V5066	Pressure sleeve set	396
01-00004	V2867	Circlip tool	339, 416–417
01-00004-013	V2992	Pin Ø 2.5 mm	339
01-00004-014	V2993	Pin Ø 3.0 mm	339
01-00004-015	V2994	Pin Ø 3.5 mm	339
01-00009	V2916	Silent block bushing set · rear · BMW	378
01-00009-001	V2995	Assembly ring	378
01-00009-002	V2996	Counterholder ring	378
01-00009-003	V2997	Washer with thread	378
01-00010-001	V3028	Washer with thread	378
01-00010-002	V2998	Thrust washer	378
01-00010-003	V3029	Retaining ring	378
01-00010-004	V3030	Mounting ring	378
01-00011-001	V3031	Washer with thread	378
01-00018	V2860	Compact wheel bearing removal set · universal	344, 348, 359
01-00018-003	V3873	Fixing screw · M 14	341, 344–345, 352–353

Wallmek-No	VIGOR No.	Designation	Page
01-00018-004	V3874	Bolt · M 12	341, 344–345, 352–353
01-00020	V2853	Spindle set · mechanical	338
01-00020-001	V3008	Drawbar with flange nut M 18	338
01-00020-002	V3206	Washer	338
01-00020-003	V3205	Thrust washer	338
01-00022-003	V3403	Pressure pipe	375
01-00022-004	V3404	Pressure plate	375
01-00022-005	V3405	Adapter ring	375
01-00022-010	V3649	Bushing set longitudinal strut · FORD · Volvo	358, 375
01-00022-020	V3650	Press frame	375
01-00023	V3436	Tool set for double silent blocks VAG	380
01-00023-001	V3423	Mounting pipe	380
01-00023-002	V3424	Thrust washer	380
01-00023-003	V3425	Pressure pipe	380
01-00024	V3751	Installation tool set for BMW drive shafts (hydraulic)	369
01-00024-001	V3709	Adapter · M 24x1.5 mm	368–369
01-00024-002	V3708	Adapter · M 27x1.5 mm	368–369
01-00024-005	V3868	Thrust washer · inside Ø 23 mm · suitable for M 20 spindle	368
01-00024-010	V3740	Installation tool set for BMW drive shafts (mechanical)	368
01-00025	V3631	Transverse control arm bushing set · front · VW T5	380
01-00025-001	V3641	Thrust plate · inside Ø 23 mm · suitable for M 22 spindle	380
01-00025-002	V3642	Pressure sleeve	380
01-00026	V3731	Removal set, universal, for screwed wheel bearing unit	345
01-00026-020	V3758	Pressure foot set (removal) for screwed wheel bearing units	345, 348, 357
01-00027	V3732	Removal set, universal, for screwed wheel bearing unit	345
01-00027-020	V3753	Pressure foot set (removal) for screwed wheel bearing units	345, 348, 357
01-00028	V3865	Wheel bearing unit / compact wheel bearing · screwed · removal set · universal	348–349
01-00030	V4551	Tractive and compressive hydraulic cylinder 18 tonnes	333
01-00030-001	V4552	Hydraulic cylinder · 18 tonnes · without accessories	333
01-00030-005	V4553	Pressure shaft · M 24x3 mm	333
01-00031-018	V4342	Striker nut · M 18	–
01-00033	V4491	Compact wheel bearing installation set · universal	352
01-00033-020	V4493	Pressure foot (pair) for compact wheel bearing assembly tool set · universal	352
01-00033-110	V3680	Compact wheel bearing installation set · universal	349, 359

References Wallmek / VIGOR



Wallmek-No	VIGOR No.	Designation	Page
01-00033-125	V3866	Wheel bearing unit and compact wheel bearing · screwed · removal / assembly tool set · universal	349
01-00035	V4598	Wheel bearing, hub tool and drive shaft set · universal	342, 356
01-00035-001	V4614	Support disc · tapered · Ø 33.8 mm · for V4598	342, 357
01-00035-002	V4598-2	Support disc · tapered · Ø 38.8 mm · for V4598	342, 357
01-00035-003	V4598-3	Support disc · tapered · Ø 43.8 mm · for V4598 · V4599	342-343, 357
01-00035-004	V4598-4	Support disc · tapered · Ø 59.8 mm · for V4598	342, 357
01-00035-010	V4598-10	Bearing washer Ø 61.8 – 62.8 mm · inside hole Ø 20.25 mm · suitable for spindle M 20	342
01-00035-011	V4598-11	Bearing washer Ø 63.8 – 64.8 mm · inside hole Ø 20.25 mm · suitable for spindle M 20	342
01-00035-012	V4598-12	Bearing washer Ø 65.8 – 66.8 mm · inside hole Ø 20.25 mm · suitable for spindle M 20	342-343
01-00035-013	V4598-13	Bearing washer Ø 68.8 – 70.8 mm · inside hole Ø 20.25 mm · suitable for spindle M 20	342
01-00035-014	V4598-14	Bearing washer Ø 72.5 – 74.5 mm · inside hole Ø 20.25 mm · suitable for spindle M 20	342
01-00035-015	V4598-15	Bearing washer Ø 76.5 – 78.5 mm · inside hole Ø 20.25 mm · suitable for spindle M 20	342
01-00035-016	V4598-16	Bearing washer Ø 80.8 – 82.8 mm · inside hole Ø 20.25 mm · suitable for spindle M 20	342
01-00035-020	V4598-20	Bearing shell Ø 93 mm for V4598	342
01-00035-021	V4598-21	Bearing shell Ø 75.5 mm for V4598	342
01-00035-022	V4598-22	Bearing shell Ø 93 mm for V4598	342
01-00035-030	V4598-30	Pressure pipe length 78 mm for V4598 · V4599	342-343, 357
01-00036	V4594	Wheel bearing fixation adjustable	343
01-00036-020	V4594-1	Pressure foot set for V4594	343
01-00037	V4629	Wheel hub removal tool · universal	341, 356
01-00037-020	V4629-1	Pressure foot set for V4629	341, 357
01-00038	V4599	Wheel bearing tool set AUDI Q7 · VW Touareg · PORSCHE Cayenne	343
01-00039	V4699	Pressure spindle set · manual	338
01-00039-001	V4699-1	Pressure spindle · M 30	338
01-00039-002	V4699-2	Adapter · 1.1/2" · M 30	338
01-00039-010	V4699-4	Press axle · 50xØ 19 mm	338
01-00039-011	V4699-5	Press axle · 85xØ 19 mm	338
01-00039-020	V4699-6	Press axle · 56xØ 24 mm	338
01-00039-021	V4699-7	Press axle · 100xØ 24 mm	338
01-00039-040	V4699-3	Washer Ø 18.8x3 mm (4 pcs)	338

Wallmek-No	VIGOR No.	Designation	Page
01-00040	V5027	Wheel hub puller	351, 362
01-00041-002	V3871	Cross beam for various pressure feet	341, 344-345, 352-354, 367
01-00041-003	V5904-3	Sliding plate	354, 367
01-00041-005	V5904-4	Screw · M 14 x 45 · inside hexagon	354, 367
01-00041-020	V3755	Pressure foot set (removal) for compact wheel bearings	344
01-00042-002	V5903-2	Washer	-
01-00042-003	V5903-3	Drawbar · M 22 · 121 mm	351
01-00042-010	V7061	Screw set for SUBARU rear wheel bearings	350
01-00042-B	V5903N	Wheel bearing puller for screwed wheel bearings	351
01-00044	V5904	Device for the removal of drive shafts · 6 and 8 holes	354
01-00044-030	V5904-1	Pressure foot set	354
01-00045	V5905	Wheel hub / wheel bearing puller · for 6 and 8 bolts	353, 362
01-00046	V5906	Wheel bearing unit · screwed · removal tool set · universal	353
01-00046-020	V5906-1	Pressure foot set	353
01-00047-020	V7050	Removal tool for screwed 4-hole wheel hubs/wheel bearings with uneven brake guard	352
01-00048	V7154-4	Brake disc removal set	367
01-00048-001	V7154-1	Removal foot · individual	367
01-00048-002	V7154-2	Fixing plate · individual	367
01-00048-030	V7154N	Extension set for brake disc removal tool without crossbar	354
01-00049	V7027	Wheel hub / bearing puller	355
01-00050-010	V5422	Bearing plate · Ø 85-95 mm	347
01-00050-011	V5423	Supporting plate · Ø 89-105 mm	347
01-00050-020	V5421	Expansion set · ROVER	347
01-00050-050	V5425	ROVER standard wheel bearing expansion set	347
01-00050-100	V5420	ROVER standard wheel bearing removal and installation set	346
02-00009	V2923	Supporting joint tool set FORD	376
02-00009-001	V2999	Pressure sleeve	376
02-00009-002	V3000	Mounting / dismantling cap	376
02-00009-003	V3001	Mounting bushing	376
02-00009-004	V3002	Dismounting bushing	376
02-00010-001	V3433	Pressure sleeve · inside Ø 23 mm · suitable for M 22 spindle	399, 403
02-00011	V7251	Multibox wheel bearing tool set IVECO Daily	402
02-00011-001	V7251-1	Pressure ring, IVECO Daily	402
02-00011-002	V7251-2	Large pressure pipe	402-403
02-00011-003	V7251-3	Bearing washer, IVECO Daily	402
02-00011-004	V7251-4	Support disc, IVECO Daily	402
02-00011-005	V7251-5	Bearing shell, IVECO Daily	402



Wallmek-No	VIGOR No.	Designation	Page
02-00015	V7133	Compact wheel bearing removal and installation set	362
02-00015-001	V7133-2	Insert thread including guide M24 · L110 mm	363
02-00015-002	V7133-3	Insert crossbar CC = 160-186 mm · L 226 mm	363
02-00015-003	V7133-4	Insert fixation L 266 mm · M14 · M16	363
02-00015-004	V7133-5	Fixing screw M14 · tapered	363
02-00015-005	V7133-6	Insert hollow shanks L 242 mm · 2x M14	363
02-00015-006	V7133-7	Insert plate CC = 135-145 mm	363
02-00015-007	V7133-8	Fixation steering knuckle M14	363
02-00015-015	V7133N	Compact wheel bearing installation expansion set	362-363
02-00020	V7275	Multifox · starter set · wheel bearing of van front axle	403
03-00003-005	V3263	Screw · M 22x60 mm	409, 412-413, 416-417
03-00004-001	V3262	Press frame	413
03-00005-001	V2937	Brake adjuster puller	414, 417
03-00006-001	V3264	Thrust rod · 250 mm Ø 31 mm	406, 409
03-00006-002	V3265	Thrust rod · 140 mm Ø 31 mm	406, 409
03-00006-006	V3266	Pressure pipe	406-407, 414-415
03-00006-007	V3267	Pressure pipe	406-407, 414-415
03-00006-009	V3261	Thrust rod · 115 mm Ø 29 mm	413
03-00006-010	V3260	Thrust rod · 100 mm Ø 29 mm	413
03-00006-011	V3259	Pressure pipe · large	413
03-00006-013	V3238	Thrust washer	415-416
03-00006-014	V3237	Thrust washer · Ø 63 mm	414, 416
03-00006-015	V3236	Thrust washer · Ø 50 mm	414, 416
03-00006-016	V3235	Thrust washer · Ø 44 mm	414, 416
03-00006-017	V3234	Thrust washer · Ø 63 mm	414, 416
03-00006-018	V3233	Thrust washer · Ø 57 mm	414, 416
03-00006-020	V3232	Thrust rod · 50 mm Ø 31 mm	406, 409
03-00006-021	V3231	Pressure plate	409, 416
03-00006-025	V3634	Spacer screw M 22	410
03-00006-026	V3440	Pressure sleeve	410
03-00006-027	V4634	Pressure pipe for V4565 · V4566	406-407
03-00006-028	V4563	Adapter plate for V4565 · V4566	406-407
03-00006-029	V4564	Pressure pipe 85 mm for V4565 · V4566	406-407
03-00006-030	V4562	Pressure sleeve for V4565 · V4566	406-407
03-00008-32T	V4601	Spring bolt set for SCANIA 32 tonnes	413
03-00008-45T	V4602	Spring bolt set for SCANIA 45 tonnes	413
03-00009	V4635	Spring bushing set · universal	414
03-00010	V2942	Bushing set for drawbars	415
03-00012	V2943	Supplementary set for changing the brake anchor bolts	-
03-00012-001	V3230	Pressure pipe	-
03-00012-003	V3227	Pressure sleeve (big)	-
03-00013	V2936	Bushing set · for SAF axle · 150 mm	415
03-00013-001	V3226	Assembly ring	415

Wallmek-No	VIGOR No.	Designation	Page
03-00013-002	V3225	Dismounting/mounting ring	415
03-00013-003	V3224	Dismounting/mounting washer	415
03-00014-001	V2920	Ball joint puller · universal	405, 416
03-00015	V2873	Tractive and compressive hydraulic cylinder 8.5 tonnes	332, 369, 416-417
03-00015-001	V3009	Hydraulic cylinder 8.5 tonnes	332
03-00015-006	V3010	Impact body with o-ring	332
03-00015-012	V3011	Thrust rod · adjustable M 22	332
03-00016-020	V3222	Pressure foot	409, 416-417
03-00016-32T	V4554	Wheel hub puller set for trucks · buses and trailers 32 tonnes	409
03-00016-45T	V4555	Wheel hub puller set for trucks · buses and trailers 45 tonnes	409
03-00020	V3434	Wheel bearing tool set for SCANIA	410
03-00020-001	V3437	Thrust washer · Ø 130 mm	410
03-00020-002	V3438	Thrust washer · Ø 125 mm	410
03-00020-003	V3439	Protective sleeve	410
03-00021-020	V4603	Universal pressure tool set 32 tonnes · universal	416
03-00021-021	V4604	Universal pressure tool set 45 tonnes · universal	417
03-00022	V3750	Wheel hub extractor for low-height trailers	412
03-00022-001	V3763	Plate	412
03-00022-002	V3764	Leg	412
03-00022-003	V3765	Thrust washer · SAF Ø 73 mm	412
03-00025	V3678	Brake disc removal (floating) · Volvo · RENAULT · DAF	405
03-00026	V4229	Tractive and compressive hydraulic cylinder 45 tonnes	334, 417
03-00026-001	V4242	Hydraulic cylinder 45 tonnes	334
03-00026-006	V4254	Impact body · M 27	334
03-00026-012	V4251	Thrust block · adjustable · M 30	334
03-00027-002	V3762	Thrust rod · M 24	411
03-00027-003	V4577	Thrust rod · M 30 for V4500	411
03-00027-010	V3761	Base component with thread	411
03-00027-012	V3867	Adapter for base component with thread	411
03-00027-32T	V4499	Wheel hub puller commercial vehicle · 32 tonnes	411
03-00027-45T	V4500	Wheel hub puller commercial vehicle · 45 tonnes	411
03-00028	V2874	Tractive and compressive hydraulic cylinder 32 tonnes	334, 416
03-00028-001	V3216	Hydraulic cylinder 32 tonnes	334
03-00031-001	V4550	Press frame for V4565 · V4566	406-407
03-00031-002	V4556	Plate with thread for V3750 · V4554 · V4555	409
03-00031-200	V4569	King pin removal expansion set	408
03-00031-201	V4570	Support for V4569	408
03-00031-202	V4571	Extension for V4569	408
03-00031-203	V4575	Extension for V4569	408

References Wallmek / VIGOR



Wallmek-No	VIGOR No.	Designation	Page
03-00031-204	V4572	Extension for V4569	408
03-00031-205	V4573	Pressure plate for V4569	408
03-00031-206	V4574	Pressure plate for V4569	408
03-00031-220	V4605	King pin removal expansion set MERCEDES-BENZ Actros und Atego	408
03-00031-221	V4610	Centring thrust block	408
03-00031-300	V4606	Steering knuckle removal expansion set MAN TGA · TGX and TGS	408
03-00031-302	V4608	Pressure pipe	408
03-00031-303	V4607	Guide ring for V4605 · V4606	408
03-00031-32T	V4565	King pin removal set 32 tonnes · universal	406, 416
03-00031-45T	V4566	King pin removal set 45 tonnes · universal	407, 417
03-00032-001	V4545	Thrust rod · M 30 · length 30 mm · Ø 38 mm	407, 409
03-00032-002	V4546	Thrust rod · M 30 · length 140 mm · Ø 38 mm	407, 409
03-00032-003	V4547	Extension · 50 mm · Ø 38 mm for V4555 · V4566	407, 409
03-00032-004	V4548	Extension · 70 mm · Ø 38 mm for V4555 · V4566	407, 409
03-00032-005	V4549	Extension · 100 mm · Ø 38 mm for V4555 · V4566	407, 409
03-00032-101	V4609	Thrust rod · M 30 · length 137 mm · Ø 29 mm · for V4605 · V602	408, 413
03-00032-102	V4602-1	Thrust rod length 64 mm Ø 29 mm	413
04-00003	V4255	Manometer	340
04-00007-001	V3287	Special nut · M 16x1.5 mm	401, 404
04-00007-004	V3013	Special nut · M 14x2 mm	401, 404
04-00015-001	V3582	Protective cover	337
04-00016	V3612	Manometer	337
04-00021	V4218	Support set for hydraulic cylinders	335
04-00021-001	V4243	Bracket without shell	335
04-00021-013	V4244	Clamp Ø 70 mm	335
04-00021-014	V4245	Clamp Ø 85 mm	335
04-00021-015	V4246	Clamp Ø 100 mm	335
04-00024	V5916	Ball joint ejector · hydraulic 4.5 tonnes	372
04-00024-023	V5916-1	Ball joint ejector extension pins	373
04-00024-024	V5916-2	Pressure foot extension	373
04-00028	V5916-XL	Ball joint ejector · hydraulic 8.8 tonnes	373, 416–417
09-000111	V7133-9	Screw sleeve 28x14.5 x 3 mm	363
1-1090-02	V3199	Hydraulic cylinder 22 tonnes	333
1-1090-03	V3217	Hydraulic cylinder 14 tonnes	332
1011	V2928	Crank for brake disc	339
1012	V2927	Scraper	339
1030	V2847	Hydraulic foot pump	340, 360
1036	V2846	Hydraulic pump · pneumatic	340, 361
1062-01	V2857	Tool set for silent blocks VW · AUDI · SEAT · ŠKODA	379
1062-01-01	V3014	Dismounting/mounting washer	379
1062-01-02	V3015	Pressure pipe	379
1062-01-03	V3016	Mounting washer	379
1062-01-04	V3017	Dismounting washer	379

Wallmek-No	VIGOR No.	Designation	Page
1064	V2922	Sliding hammer 5.2 kg	371
1066	V2871	Wheel hubs removal set for V2922	371
1068	V2872	Adapter for sliding hammer V2922	371
1068-04	V2851	Adapters for other tool systems	337
1068-05	V2910	Adapter 1/2" to G2-1/2" - 11	337
1068-06	V2850	Adapters for other tool systems	336
1068-08	V3869	Adapters for other tool systems	337
1068-10	V4220	Adapters for other tool systems	337
1086-6	V3018	Impact body · M 22x2.5 mm	333–334
1090-02-WAL	V2854	Tractive and compressive hydraulic cylinder 22 tonnes	333, 360–361, 366
1090-03	V2869	Hydraulic cylinder 14 tonnes	332
1090-14	V3256	Silent block bushing set · rear · BMW X5 · E53	379
1090-14-A6	V3302	Washer with thread · inside Ø 23 mm · suitable for M 22 spindle	379
1090-14-B6	V3019	Retaining ring	378–379
1090-14-D6	V3020	Mounting washer	378–379
1090-15-B	V3021	Pressure sleeve	378–379, 404
1090-15-B3	V3022	Retaining ring E32/E34	378
1090-15-C	V3023	Thrust washer	378–379
1090-15-D	V3024	Retaining washer E32 and E34	378
1090-18-D5	V3025	Mounting washer	378
1090-18-E5	V3026	Pressure pipe	378–379
1090-18-E6	V3027	Thrust washer	378–379
1090-20-02	V3033	Support disc Ø 32 mm · inside hole Ø 20.25 mm · suitable for spindle M 20	348, 371
1090-20-04	V3034	Support disc Ø 40 mm · inside hole Ø 20.25 mm · suitable for spindle M 20	348, 371
1090-20-06	V3035	Support disc Ø 45 mm · inside hole Ø 20.25 mm · suitable for spindle M 20	348, 371
1090-20-08	V3036	Support disc Ø 52 mm · inside hole Ø 20.25 mm · suitable for spindle M 20	348, 371
1090-20-M	V3060	Counterholder	342–343
1090-20-T10	V3063	Bearing washer Ø 63 mm · inside hole Ø 20.25 mm · suitable for spindle M 20	348
1090-20-T21	V3070	Bearing washer Ø 92 mm	343
1090-20-T22	V3071	Bearing washer Ø 95 mm · inside hole Ø 20.25 mm · suitable for spindle M 20	343
1090-22	V3072	Press frame for wheel hub removal	341
1090-25-10	V2864	Thrust washer · conical · universal	344, 348, 359
1090-25-11	V2861	Thrust washer (installation) VW · AUDI · SEAT · ŠKODA	350
1090-25-12	V2862	Thrust washer (installation) VW	350



Wallmek-No	VIGOR No.	Designation	Page
1090-25-13	V2863	Mounting ring FORD · MAZDA · Volvo	350
1090-25-14	V2859	Thrust washer (installation) FORD · MAZDA · Volvo	350
1090-25-15	V6824	Half shell set for assembling 92 mm compact wheel bearings	344
1090-26	V2845	Hub and bearing shell	341
1090-26-01	V3039	Thrust washer · large	341, 403
1090-26-02	V3040	Pressure pipe · large	341, 403
1090-30	V2849	Device for the removal of drive shafts · 4 and 5 holes	366, 370
1090-30-4	V3147	Axle drive shaft 4 holes · bolt circle 92 – 120 mm	370
1090-30-5	V3148	Axle drive shaft 5 holes · bolt circle 98 – 131 mm	370
1090-32	V3207	Set of drawbars, flange nuts and adapters	336
1090-39	V2886	Rear axle bushing tool set VW · AUDI · SEAT · SKODA	377
1090-39-06	V3213	Dismounting bushing	377
1090-39-08	V3214	Mounting bushing	377
1090-39-09	V3215	Assembly ring	377
1090-39-10	V3212	Dismounting ring	377
1090-54-01	V3045	Pressure sleeve	376
1090-54-02	V3046	Pressure sleeve	376
1090-54-03	V3047	Pressure sleeve	376
1090-54-04	V3048	Mounting bushing	376
1090-54-05	V3049	Dismounting ring	376
1090-54-06	V2915	Supporting joint dismounting bushing, MERCEDES-BENZ	376
1090-54-10	V2913	Supporting joint tool set MERCEDES-BENZ	376
1090-54-11	V2914	Stabilizer ball joint tool set MERCEDES-BENZ	376
1090-54-12	V2917	Control arm bushing set · rear · MERCEDES-BENZ	381
1090-54-12-001	V3050	Dismounting ring	381
1090-54-12-002	V3051	Mounting bushing	381
1090-54-12-003	V3052	Pressure pipe	381
1090-54-12-004	V3044	Retaining ring, installation	381
1090-55-C	V2858N	Press frame for changing supporting joints and ball joints of stabilizers	405
1090-60-01	V3053	Plate with thread	358, 374–375
1090-60-03	V3055	Support	374
1090-60-04	V3056	Screw · M 16x40 mm	358, 363, 374–375
1090-60-05	V3057	Open plate	374
1090-60-06	V3142	Adapter plate	374
1090-61-01	V2909	Pressure piece for supporting joint tool	374
1090-61-02	V2908	Pressure piece for supporting joint tool	374
1090-61-03	V2907	Pressure piece for supporting joint tool BMW E 36 outside	374

Wallmek-No	VIGOR No.	Designation	Page
1090-62-01	V2906	Pressure piece for supporting joint tool BMW E 30 · E 36 inside, MERCEDES-BENZ 124	374
1090-62-02	V2905	Pressure piece for supporting joint tool BMW E 30 · E 36 inside, MERCEDES-BENZ 124	374
1090-62-03	V2904	Pressure piece for supporting joint tool BMW E 30 · E 36 inside	374
1090-62-08	V2903	Pressure piece for supporting joint tool	374
1090-64-01	V2902	Pressure piece for supporting joint tool e.g. MERCEDES-BENZ 124	374
1090-66-01	V2901	Pressure piece for supporting joint tool	374
1090-66-03	V2900	Pressure piece for supporting joint tool VW LT35	374
1090-66-04	V2899	Pressure piece for supporting joint tool NISSAN Interstar · OPEL/VAUXHALL Movano · RENAULT Master	374
1090-66-05	V2898	Pressure piece for supporting joint tool for NISSAN Interstar · OPEL/VAUXHALL Movano · RENAULT Master · HYUNDAI Trajet · Santa Fé	374
1090-66-06	V2897	Pressure piece for supporting joint tool	374
1090-66-07	V2896	Pressure piece for supporting joint tool	374
1090-66-08	V2895	Pressure piece for supporting joint tool	374
1090-66-09	V2894	Pressure piece for supporting joint tool (removal)	374
1090-66-10	V2893	Pressure piece for supporting joint tool	374
1090-68-01	V2892	Pressure piece for supporting joint tool	374
1090-68-02	V2891	Pressure piece for supporting joint tool	374
1090-68-03	V3094	Pressure sleeve	–
1090-68-04	V3093	Pressure sleeve	–
1090-68-05	V3095	Pressure sleeve	–
1090-68-20	V2884	Rear axle bushing set RENAULT	–
1090-69-20-B	V5902	Rear axle bushing set	358, 377
1090-69-21	V3100	Dismounting/mounting bushing	377
1090-69-22	V3101	Mounting washer	377
1090-69-23	V3102	Retaining ring	377
1090-69-24	V3103	Thrust washer	377
1090-69-25	V5902-1	Mounting bushing	377
1090-69-26	V5902-2	Retaining ring	377
1090-69 1090-60-06	V2885	Press frame with open plate with adapter to close the plate	374
1091-10	V2879	Wheel bearing tool set · front, FORD	400
1091-10-04	V3088	Support disc · inside Ø 23 mm · suitable for M 22 spindle	399, 403
1091-11	V3087	Wheel hub tool	403
1091-15-01	V3090	Adapter ring	404
1091-17	V2889	Wheel bearing tool set · front · CITROËN · FIAT · PEUGEOT	398
1091-17-01	V3105	Pressure ring	398
1091-17-02	V3106	Thrust washer · Ø 170 mm	398–399, 402–403, 415

References Wallmek / VIGOR



Wallmek-No	VIGOR No.	Designation	Page
1091-17-03	V3107	Pressure pipe	398–399, 415
1091-17-04	V2881	Bearing washer for CITROËN · FIAT · PEUGEOT wheel bearing tool set · front · inside Ø 23 mm · suitable for M 22 spindle	398–399, 403
1091-17-05	V3108	Bearing washer · inside Ø 23 mm · suitable for M 22 spindle	398, 402–403
1091-17-06	V3109	Counterholder	398, 403
1091-17-07	V2882	Support disc for CITROËN · FIAT · PEUGEOT wheel bearing tool set · front	398, 403
1091-17-08	V3149	Pressure pipe	398–399, 402–403
1091-17-09	V3091	Support disc · inside Ø 23 mm · suitable for M 22 spindle	398, 403
1091-17-M22	V3092	Striker nut	334, 410
1091-18	V2883	Pressure ring for wheel bearing tool set · front · CITROËN · FIAT · PEUGEOT	398–399, 403
1091-23	V2888	Wheel bearing tool set · front · NISSAN · OPEL/VAUXHALL · RENAULT	399
1091-23-01	V3113	Pressure ring set Ø 89 mm	399
1091-23-02	V3112	Bearing shell	399
1091-23-03	V3110	Thrust washer · Ø 89 mm	399, 403
1091-23-04	V3111	Thrust washer	399
1091-24-001	V2951	Wheel bolt change tools for trucks · universal	–
1091-24-001-01	V3246	Mounting bushing	–
1091-24-001-02	V3245	Counterholder	–
1091-24-001-03	V3244	Dismounting pipe large Volvo · SMB	–
1091-24-001-04	V3243	Dismounting pipe small Volvo	–
1091-24-001-05	V3242	Dismounting bushing SCANIA	–
1091-24-001-06	V3241	Thrust rod · adjustable M 24	–
1091-24-001-08	V3239	Dismounting pipe BPW · ROR	–
1091-28	V2890	Drive shaft tool, 5 holes, for transport vehicles	401, 404
HSC 2008-1119	V4476-1	Adapter ring for OPEL/VAUXHALL Insignia	385
HSC2008-1118	V4354	Spring plate Ø 150 – 240 mm with locking element	385
HSC2018	V4476N	Hydraulic safety spring vice including 10 spring plates	382
HSC2018-1126	V4307N	Spring vice · hydraulic · universal	–
RES 1030-01	V3614	Gasket set	340
RES 1030-02	V3120	Hydraulic hose	340
RES 1090-01-09	V3123	Pressure foot M 24 x 3 mm	333

Wallmek-No	VIGOR No.	Designation	Page
RES 1090-01-10	V3124	Thrust rod · adjustable M 24	332–333
RES 1090-01-13	V3125	Protection ring for thread 1.1/2"	333
RES 1090-02-04	V3134	Pressure shaft M 24x3 mm	333
RES 1090-05-02	V3130	Thrust block · adjustable M 24	333–334
RES 1090-05-04	V3131	Protection ring for thread 2.5	334
RES 4305	V3012	CEJN fitting hydraulic · 1/8 inch	332
RES1090-01-12	V3129	Thrust block · adjustable M 24	333, 376
RES4009	V4596	Adapter · M 18 – M 22	–
RES4010	V3135	Adapter · M 22x2.5 – M 14x2.0	336, 378, 380–381
RES4011	V3219	Adapter · M 22x2.5 – M 12x1.75	336
RES4012	V3209	Adapter · M 22x2.5 – M 10x1.5	336
RES4014	V3210	Drawbar · M 10 · maximum 6 t	336
RES4015	V3220	Drawbar · M 12 · maximum 9 t	336
RES4016	V3136	Drawbar · M 14 · maximum 12 t	336, 378, 380–381
RES4021	V3137	Flange nut · M 14x2.0	336, 379–381
RES4022	V3208	Flange nut · M 12x1.75	336
RES4023	V3275	Flange nut · M 10x1.5	336
RES4024	V3126	Flange nut · M 18x2.5	333, 336, 338, 371, 414, 416
RES4025	V3132	Flange nut · M 22x2.5	334, 336, 368, 410
RES4026	V3127	Drawbar · M 18 M 22 · maximum 22 t	333, 336, 378–379, 414, 416
RES4027	V3133	Drawbar · M 22 · maximum 32 t	334, 336, 368–369
RES4028	V3138	Drawbar M 14	379
RES4029	V3139	Drawbar M 18 / M 22	378
RES4030	V3140	Drawbar M 18	371
RES4034	V3431	Drawbar · M 22	410, 415
RES4035	V4252	Flange nut M 27	334
RES4036	V4253	Drawbar · M 27 · maximum 50 t	334
RES4039	V4597	Adapter · M 27 – M 22	–
RES4304	V3141	(CEJN-) quick coupler connection	340
RES4306	V3128	(CEJN) fitting, hydraulic	332–334
RES4307	V6591	Adapter 3/8" outside thread · on CEJN / cylinder	337
RES4308	V6592	Adapter 3/8" inside thread · on CEJN / pump	337



Your specialist for chassis tools





**MOTOR VEHICLES /
COMMERCIAL VEHICLES**



Please contact us:

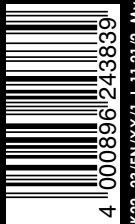
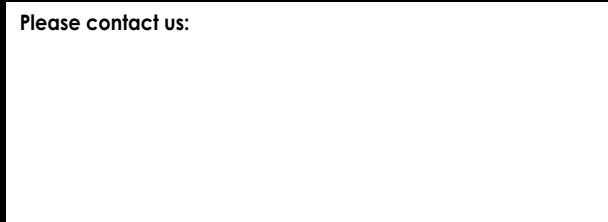

K22_23/EN/XX/1 i. 11.21/2. My/Mö

Products available as long as stock lasts!
VIGOR GmbH · Am Langen Siepen 13-15 · D-42857 Remscheid · GERMANY
info@vigor-equipment.com · www.vigor-equipment.com

All rights reserved regarding technical modifications. Figures may not always correspond to the original and are thus not binding! We accept no liability for printing errors! Copyright 2022/23 by VIGOR GmbH

EINFACH VIGOR.